

ham radio

magazine

hr
ANNUAL
ANTENNA ISSUE

- antenna geometry for top performance
- Fresnel-zone plate for 10.4 GHz
- improved cylindrical feedhorns
- the half-delta loop

hr

focus
on
communications
technology

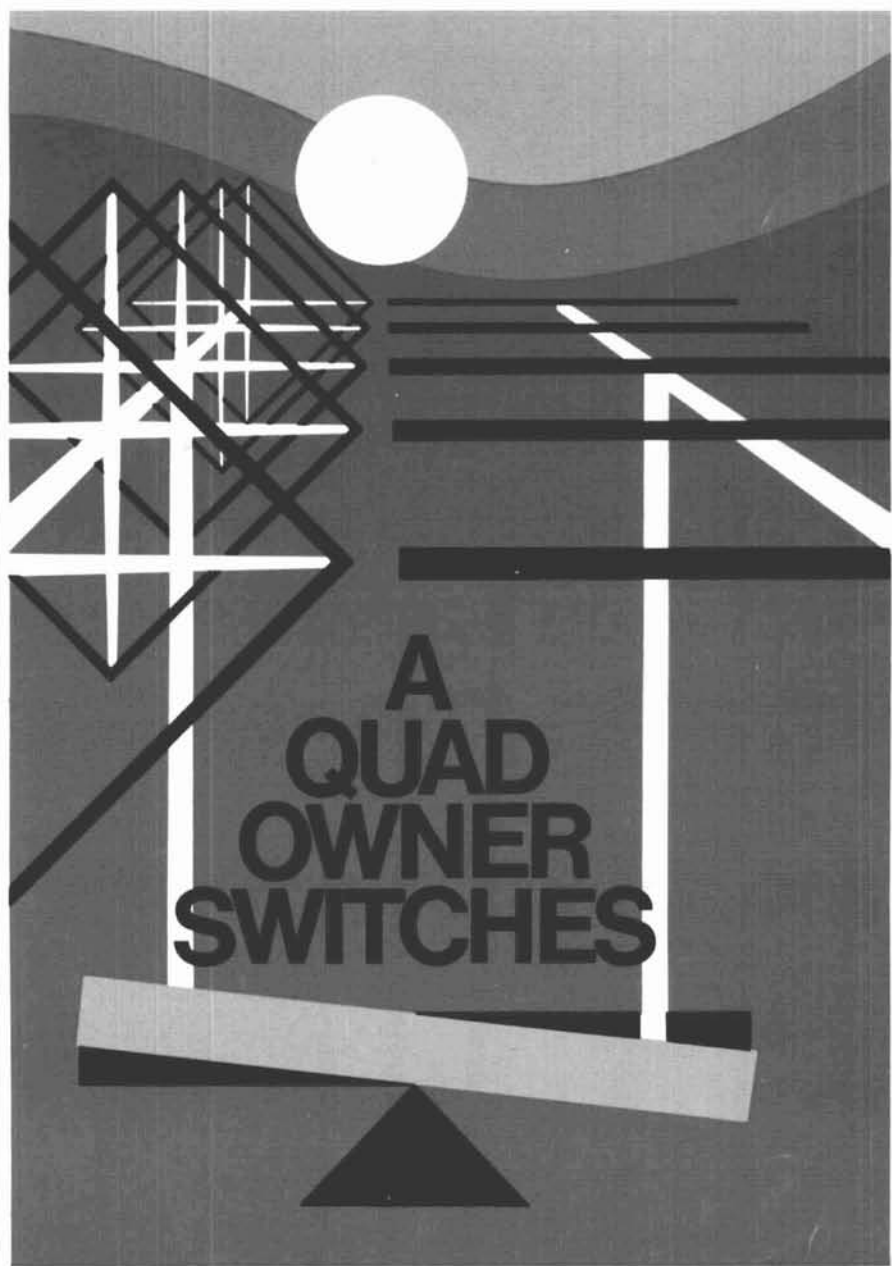

ICOM VHF Mobile

Amateur Communications using Space Age Techniques

ICOM's smallest 2 meter FM mobile, the IC-25A offers extremely compact size (5½" x 2" x 7" deep) without sacrificing features: 25 watts, 5 memories, 2 scanning systems, priority channel, 2 VFO's and touchtone™ HM-8 microphone standard.



The best 2 meter multimode mobile on the market today, the IC-290A has features to make multimode mobile a snap. 2 VFO's, 5 memories, priority channel, memory and band scanning, squelch on SSB, selectable AGC and NB and RIT. Touchtone™ encoding provided with HM-8 microphone standard.



6 meter mobile at its best with the IC-560, a multimode mobile transceiver for working FM repeaters or sideband simplex, local or DX, 3 memories, 2 VFO's, scanning, squelch on SSB.



Sensible and affordable, the IC-22U offers simplicity with ease of operation. Easy to use push buttons for up and down tuning. 800 channels at the push of a button. 4 MHz coverage. EX-199 optional remotable frequency selector.

SATURN V

STATE-OF-THE-ART

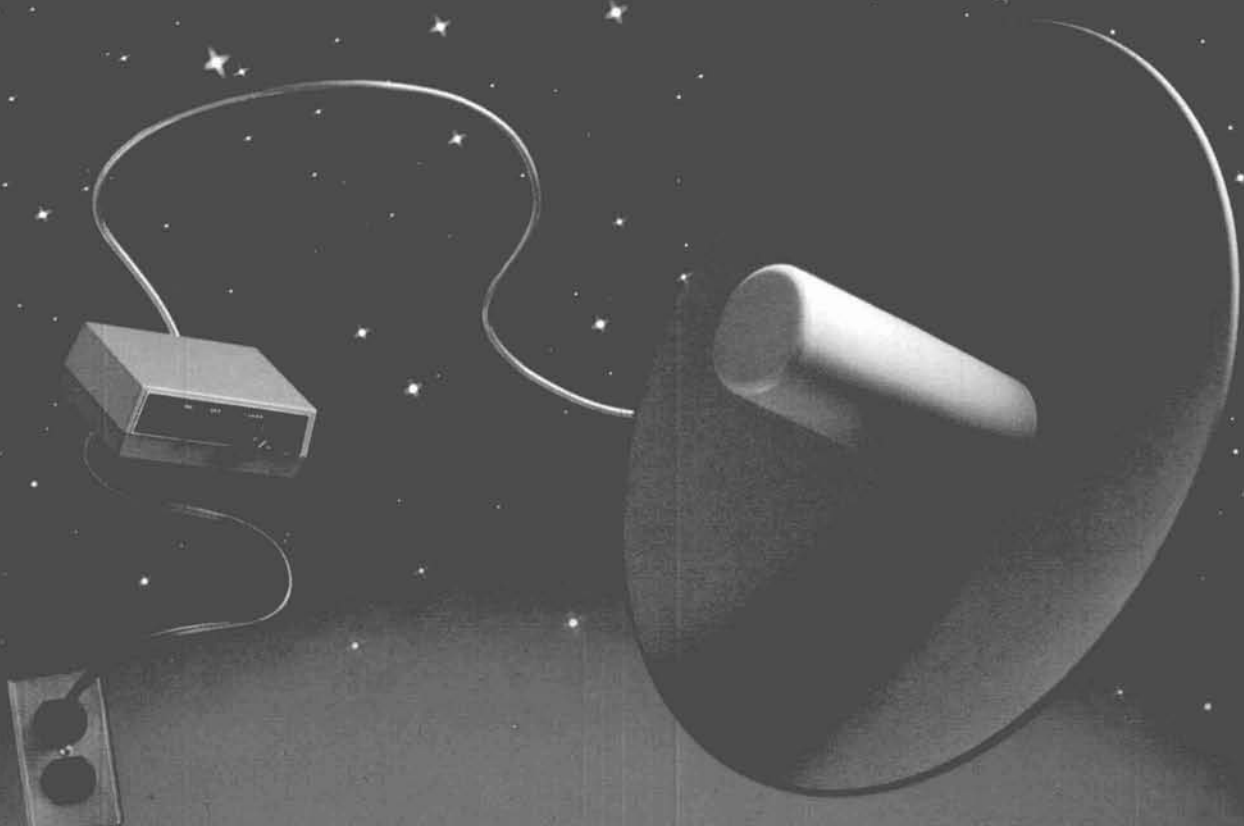

The Saturn V is a high technology microwave downconverter featuring State-of-the-Art electronics for general microwave usage in the frequency range of 2.0 to 2.5 Ghz. The Saturn V is a 40db Gain Microwave Communication system designed for the experimenter and quality conscious amateur. The Saturn V is designed to be mounted with a clean line of sight (50 to 60 miles) of the transmission tower in the area.

Design/Performance features:

- High Gain: 40db typical
- Low Noise: 2-2.5 db
- Tuning Range: 2-2.5 Ghz
- High Selectivity: 30 db
- Dynamic Range: 60 dbmv
- Output Impedance: 75 ohms
- Range: Line of Sight: 200 miles
- Tunes 54 thru 75 Mhz
- IF Frequency (channels 2-6)
- 20" Dia.

Parabolic Antenna • No-drift temperature compensated VCO • Dish mounted down-converter eliminates external antenna • Precision regulated power supply • 60' cable, cable adapters, brackets and hardware included • 6 month warranty

Suggested Retail \$245.00

Summer Special \$169.99

Microwave and Satellite Systems

JDL 
Industries T.M.

4558 Auburn Blvd., Suite 208
Sacramento, California 95841 (916) 454-2190

New Drake TR5 Transceiver



far above average!

COMING SOON:
RV75 Synthesized VFO
featuring the Drake "VRTO"

- Frequency Synthesized for crystal-controlled stability
- VRTO (Variable Rate Tuning Oscillator*) adjusts tuning rate as function of tuning speed.
- Resolution to 10 Hz
- Three programmable fixed frequencies for MARS, etc.
- Split or Transceive operation with main transceiver PTO or RV75

* Patent pending

With the new TR5 versatility and value are spelled D-R-A-K-E...

DYNAMIC RANGE

The dynamic range of the TR5 is unexcelled by any transceiver in its class. The TR5's greater than 0 dBm third order intercept point (85 dB two-tone dynamic range) at 20 kHz spacing can be achieved only by the use of a passive diode-ring double balanced mixer. Drake was the first to bring this technology to the Amateur market with a high-level mixer in the TR7.

RELIABLE SERVICE

When you purchase a TR5, or any Drake product, you acquire a product of the latest production techniques, which provide reliable performance.

Yet with a product as sophisticated as one of today's transceivers, after-sales service is a must. Ask any Drake owner. Our Customer Service Department has a reputation second to none.

ACCESSORIES

Drake is the only Amateur Radio manufacturer who offers a full complement of accessories to satisfy almost every desire the HF Amateur may have. This wide selection allows any operator to assemble a station which meets his needs, and assures compatible interfacing and styling instead of a desk full of equipment with a variety of styling and poor operation as a system.

KILOWATT AMPLIFIER

Everyone wants to be heard! The accessory L75 and its 3-500Z (1200 watts PEP input) and a decent antenna will do the trick. This rugged self-contained amplifier / power supply will put the TR5 on an even footing with the best of them.

ENGINEERING

The TR5 and all Drake Transceivers, are backed by the best in engineering. The TR5 is the result of an extensive engineering effort, combining proven past techniques and ideas with new state of the art concepts.

As a result, the TR5 will not be superseded by a new model every six months. It represents a true radio communications value that will provide many years of operating enjoyment.

See your Drake dealer
or write for
additional information.

R. L. DRAKE COMPANY



540 Richard St., Miamisburg, Ohio 45342, USA
Phone: (513) 866-2421 • Telex: 288-017

Features, availability and prices subject to change without notice or obligation.

ham radio

magazine

MAY 1982

volume 15, number 5

T. H. Tenney, Jr., W1NLB
publisher and
editor-in-chief

Alfred Wilson, W6NIF
editor

editorial staff

Martin Hanft, KA1ZM
production editor

Joseph J. Schroeder, W9JUV
Leonard H. Anderson
associate editors

Susan Shorrock
production

Wayne Pierce, K3SUK
cover

publishing staff

J. Craig Clark, Jr., N1ACH
assistant publisher and
advertising manager

Susan Shorrock
circulation manager

ham radio magazine
is published monthly by
Communications Technology, Inc
Greenville, New Hampshire 03048-0498
Telephone: 603-878-1441

subscription rates

United States: one year, \$16.50
two years, \$28.50; three years, \$38.50

Canada and other countries (via Surface Mail)
one year, \$21.50; two years, \$40.00
three years, \$57.00

Europe, Japan, Africa (via Air
Forwarding Service) one year, \$28.00

All subscription orders payable in
United States funds, please

foreign subscription agents

Foreign subscription agents are
listed on page 89

Microfilm copies
are available from
University Microfilms, International
Ann Arbor, Michigan 48106
Order publication number 3076

Cassette tapes of selected articles
from *ham radio* are available to the
blind and physically handicapped
from Recorded Periodicals
919 Walnut Street, 8th Floor
Philadelphia, Pennsylvania 19107

Copyright 1982 by
Communications Technology, Inc
Title registered at U.S. Patent Office

Second-class postage
paid at Greenville, N. H. 03048-0498
and at additional mailing offices
ISSN 0148-5989

Postmaster send Form 3579 to *ham radio*
Greenville, New Hampshire 03048-0498



contents

12 a quad owner switches

Wayne Overbeck, N6NB
and Dave Bell, W6AQ

**18 dipole antenna over
sloping ground**

Randy Rhea, N4HI

**24 inductance-tuned lowpass
antenna matching unit**

Richard Silberstein, W0YBF

**31 second generation
cylindrical feedhorns**

Norman J. Foot, WA9HUV

37 the half-delta loop

John S. Belrose, VE2CV

**44 a Fresnel-zone plate
for 10.4 GHz**

William M. Brooks, WB6YVK

54 another balun design

Fred Brown, W6HPH

**60 antenna geometry for
optimum performance**

Henry G. Elwell, Jr., N4UH

68 ham radio techniques

Bill Orr, W6SAI

100 advertisers index

8 comments
50 DX forecaster
89 flea market
72 ham calendar
76 ham mart

40 ham notes

83 new products
**7 observation and
opinion**
10 presstop
100 reader service

introducing a new dimension...

COMPUTERIZED ANTENNA CONTROL FROM PRO-SEARCH™

**For Contesters,
DX'ers, Handicapped
Operators and General
Purpose Ham
Operators:**

**The Most Advanced
Antenna Control
Available...**

- The Only Computerized Unit
- The Only Talking Unit
- The Only Scanning Unit
- The Only Programmable Unit
- The Only Automatic Braking Unit

Contesters:

Pro-Search seeks out a pre-programmed heading, plus stores various common headings and automatically scans for those rare multipliers, giving the operator hands-free operation and more time for contesting.

DX'ers:

Pro-Search loads in short path and long path headings and with the touch of a button, the system works between both headings. Plus you have all of the other features of the Pro-Search to aid you in catching that rare DX station.

Handicapped Operators:

Pro-Search offers ease of operation...control the entire system with just one touch. A talk loop...vocally calls out the headings, allowing blind operators to accurately program and hear their headings.

General Purpose Operators:

Pro-Search has numerous uses. Pre-set beam headings for SKEDS, VHF WORK, and many others. Current headings can be read, by displaying the present directions with LEDS. Pro-Search also displays and stores the last heading worked, which can be recalled by the Auto-Locate system with the touch of a button.



Current Heading Display

Last Heading Display and Visual Confirmation of Computer Instructions

Programmable Keyboard and Memory Functions

**Pro-Search Is
Adaptable To Many
Systems, Simple
To Install.**

No modifications are necessary.

Disconnect your present antenna control system and connect ours.

Pro-Search is presently used with HAM-M, HAM-II, III, IV, and T*X. Other models will be available to work with the HDR-300, etc.

To Order:

1-800-325-4016
1-314-994-7872 (Missouri)

Or write:

Pro-Search Electronics
A Division of Wurdack and
Associates, Inc.
10411 Clayton Road
Suite 305
St. Louis, Missouri 63131

* Patent Pending

PRO-SEARCH
Reaching The World



SAVE \$13.50* with home delivery

*(One year newsstand cost \$30.00)

Here's my address label, enter my subscription. Payment enclosed

\$16.50

Bill me later

\$28.50

\$38.50 u. s. prices

1 Year 12 issues

2 Years 24 issues

3 Years 36 issues

Name _____ Zip _____

State _____

Address _____

City _____

Check here if this is your renewal (attach label)

Subscribe to **ham radio** magazine

Foreign rates: Europe, Japan and Africa, \$28.00 for one year by air forwarding service. All other countries \$21.50 for one year by surface mail. Please allow 4-6 weeks for delivery of first issues.

Please
enter my
subscription



BUSINESS REPLY CARD

First Class Permit No. 1 Greenville, NH

Postage Will Be Paid By Addressee

NO POSTAGE
NECESSARY
IF MAILED
IN THE
UNITED STATES



**ham
radio**

Greenville, NH 03048

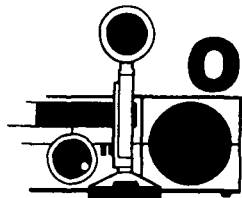

Observation & Opinion

This month I present a guest editorial by one of our authors, Gary O'Neil, N3GO. Gary feels that operating procedures on 2-meter fm need to be changed and offers his suggestions. Alf Wilson, W6NIF, editor.

When the subject of Amateur Radio slips into a casual conversation, I spend a great deal of energy playing the role of recruiter. If successful enough at motivating an individual to join the family, I like to make his transition painless.

My latest recruit, although a licensed Amateur, had been inactive for some time. With a bit of persistence and a great deal of encouragement, I was able to pry him out of the closet and sell him on the virtues of 2-meter fm. After some shopping around, he was able to locate a nice compact 2-meter fm rig and carefully proceeded with the neat installation of his new acquisition into the family car.

Formerly an a-m operator on the high-frequency bands, but having some appreciation for channelized line-of-sight communications, he correctly deduced that a lengthy CQ would not be necessary. After listening to the limit of his patience, he decided to try "CQ, CQ CQ this is WA2— listening for any calls. What say somebody please?" He was answered immediately, welcomed to 2 meters, and quickly informed he was using incorrect procedure. On a few occasions that followed, he tried several variations of CQ with similar results until a neighborhood ham informed him, "You just don't call CQ on 2 meters!"

After a week or more of announcing he was listening on frequency to all of his available channels without response, he retreated back into the closet concluding that 2 meters is not used for talking. If current procedures were effective, I would be less likely to agree with him, but personal observations tend to support his comment. The "acceptable" procedure is not only ineffective, it is cold and uninviting.

The use of "listening on" or "monitoring" implies, "Call me if you have something important, otherwise I would rather not talk to anybody." Personally, I can justify only two reasons for calling a listener:

1. I know the person and I have something to discuss.
2. The person appears to have equipment trouble and should be made aware of it.

Another classic is, "QRZ the frequency?" If there truly is a stupid question, this one fits the category. Several hours of silence are broken by "QRZ . . . This is N2—!" This in turn is followed by — what else? Why, several hours of silence of course. Did that person really detect somebody calling him? The truth is, I am supposed to interpret the announcement as a CQ and give him a call — I think.

Clearly, if one announces he is listening, he is being self-contradictory; for at that moment, he is in fact talking and unable to receive. The obvious idea here is that the listeners wish to let other listeners know that they are not listening alone. Stated another way, they want everybody to hear them listening. On many occasions, I have heard stations respond by calling the listener after perhaps 30 seconds or so of inactivity. You guessed it — the listener got impatient and went off to listen somewhere else.

Collectively, these procedures tend to discourage and minimize 2-meter activity, which today is in competition with the TV cable industry. If we don't demonstrate our intentions to keep it active, we could very likely lose the 2-meter band. If it continues to appear we are going the way of CB, the FCC may decide to take early corrective action before the situation becomes uncontrollable. If the extreme sounds far-fetched (that is, the total loss of 2 meters), consider the "egg on the face" circumstances that CB has created for the FCC. How many times does one run out of gas before he starts watching the fuel gauge? The broadcast industry may or may not have a powerful lobbying organization, but why take the risk?

Aside from the legal ramifications, what is the problem with making Amateur Radio operating procedures at least spectrally universal? Why is calling CQ such a "no-no" on fm and shamefully sinful on a repeater especially? Why the concern with regard to the occasional use of a practical and informative operating procedure even though it differs from a habit created by a narrow view of the Amateur Radio disciplines?

Different modes, for convenience or efficiency, use formal operating procedures for very good reasons, such as high-volume traffic handling; but I fail to understand why a desire to communicate on 2 meters, in a manner similar to communications carried on in the high-frequency spectrum, needs to be initiated differently. Lengthy calls on 2 meters are in no way very useful and in the case of repeater operation, the procedure is even undesirable, but a short CQ can at the very least be tolerated.

Announce your desire to chat and assume listeners are present. CQ sounds like "seek you" and is perhaps key to its origin. More important, CQ invites conversation with newcomers and may just open a lot of doors. The use of abbreviations, Q-signals and slang creates the impression of a clique organization closed to outsiders. The image that 2 meters exhibits today discourages more than encourages, and I for one am bewildered by how it all began.

Lately, when I am coaxed into a ham radio demonstration, I hide my 2-meter rig, tune up on 40 and introduce my new recruits to some good-old-fashioned ham radio hospitality. When they are just about hooked, I take them out to the car, key up the local autopatch, and call their family to encourage their support. Then I immediately shut off the rig and send them home. If I ever happen to hear them calling CQ on the local machine, we will likely have a very nice chat. When we finally sign, they will never know that they goofed.

Gary O'Neil, N3GO

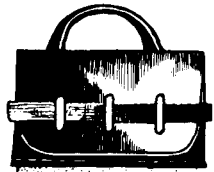

comments

one-wavelength versus full-wave

Dear HR:

Several correspondents have indicated an error in my January, 1982, article, "A Neglected Antenna for 40 and 80 Meters."

There can be a difference between a one-wavelength and a full-wave antenna. The one-wavelength reference pattern in my article was taken from Fig. 2-47 of the thirteenth edition *ARRL Antenna Book*. The text does not qualify this pattern as that of a harmonic antenna or a full-wave antenna, although it should.

If the one-wavelength wire were end fed, it would then theoretically match the reference pattern. End feeding would cause currents on each end of a one-wavelength wire to be out of phase; the antenna would qualify as a full-wave antenna and therefore nulls would appear broadside to the plane of the antenna. The center-fed, full-wavelength configuration will cause currents to flow in phase on both halves of the dipole. The result will be increased radiation from the sides of the antenna with the minimum lobe at the ends, and not as my reference pattern shows.

Using half-wave attachments to the open-wire feedline and selecting the proper impedance as I have shown in my article is still a good idea for maintaining a near omni-pattern.

I have written to the ARRL asking that the full-wave pattern (Fig. 2-47) be further qualified in the text and identified as that associated with a harmonic antenna. I understand that a new edition of the *Antenna Book* is in process.

Warren U. Amfahr, W0WL
Des Moines, Iowa

cheapie coax

Dear HR:

Gary O'Neil's article on traps in the October, 1981, issue of *ham radio*, page 10, was the answer to one of my antenna problems. I made a pair of 7-MHz traps to add to a 40-meter antenna for temporary or emergency use so it could be used on 40 or 80.

One of the other hams at work said he needed some traps for an antenna he wanted to build, so I took Gary's article to work for him to read at lunch. Several days later he said he'd made a pair of traps for 10 meters and they worked well.

Then he made a pair for 20, and crazy things started happening. One trap grid-dipped at 14 MHz and the other at 16 MHz. Investigation revealed that the 16-MHz trap was wound with a scrap of cheapie grade coax that had about 55 to 60 percent coverage by the outer conductor. The trap was rewound with a piece of good grade coax and it dipped at 14 MHz. Cheapie coax may be good for some things, but for traps, no cotton-pickin' way.

Wayne Stump, WB4AHZ
Lake Worth, Florida

good night!

Dear HR:

I'd like to respond to the comments of W6BQD in the January issue. The gentleman should recall the Biblical parable about attending to the beam in one's own eye before worrying about the dust mote in someone else's. For example, the best insult he could come up with for hams who

like amusing phonetics is to liken them to folks from the "CB bands." The phrase is just as silly, grammatically, as 73s: it means Citizen Band bands.

While cute phonetics can easily be a problem for DX work, they shouldn't be for native speakers of English. Moreover, the clean ones are a lot easier to remember. For example, who could forget Under Forbidden Skies? Try it in standard phonetics. I don't know about low-band voice, but these memory aids are very common on 2 meters — and an awful lot of 2-meter ops, including myself, have never used a CB.

I think the FCC's objection to the use of Q signals on voice should also extend to the use of 73 — even though I use it myself, as well as a very common Q signal or two. The philosophy is the same: these were intended as abbreviations in CW work. There are some hams who don't know all of the Q signals, and (according to W6BQD) there are quite a few who don't know how to use the numbers right. Maybe we should all try *good night* for a change. It takes no more time to say, and it's a lot friendlier.

Phyllis M. Gilmore, KA6NFD
Colton, California

the other guy

Dear HR:

Your request to appeal to Chairman Fowler to "seek a relaxation of the projected cuts" is not, I hope, typical of all Amateurs.

We have requested reduction of government spending and government controls — but some people think it should be for the "other guys," and not where it affects "me."

As Amateurs, we should step in and offer our help to replace the services that the government will no longer provide. We probably can do it better and at less expense.

John Waterhouse, KA2GXS
East Aurora, New York

MFJ ANTENNA TUNERS ¹⁶ MODELS

MFJ-941C 300 Watt Versa Tuner II

Has SWR/Wattmeter, Antenna Switch, Balun. Matches everything 1.8-30 MHz: dipoles, vees, random wires, verticals, mobile whips, beams, balanced lines, coax lines.



Ham Radio's most popular antenna tuner. Improved, too.

\$89⁹⁵ (+ \$4)

Fastest selling MFJ tuner . . . because it has the most wanted features at the best price.

Matches everything from 1.8-30MHz: dipoles, inverted vees, random wires, verticals, mobile whips, beams, balanced and coax lines.

Run up to 300 watts RF power output.

SWR and dual range wattmeter (300 & 30 watts full scale, forward/reflected power). Sensitive meter measures SWR to 5 watts.

Flexible antenna switch selects 2 coax lines, direct or through tuner, random wire/balanced line, or tuner bypass for dummy load.

12 position efficient air-wound inductor for lower losses, more watts out.

Built-in 4:1 balun for balanced lines. 1000V capacitor spacing.

Works with all solid state or tube rigs.

Easy to use, anywhere. Measures 8x2x6", has

SO-239 connectors, 5-way binding posts, finished in eggshell white with walnut-grained sides.

4 Other 300W Models: MFJ-940B, \$79.95 (+ \$4), like 941C less balun. MFJ-945, \$79.95 (+ \$4), like 941C less antenna switch. MFJ-944, \$79.95 (+ \$4), like 945, less SWR/Wattmeter. MFJ-943, \$69.95 (+ \$4), like 944, less antenna switch. Optional mobile bracket for 941C, 940B, 945, 944, \$3.00.

MFJ-900 VERSA TUNER



MFJ-900
\$49⁹⁵ (+ \$4)

Matches coax, random wires 1.8-30 MHz.

Handles up to 200 watts output; efficient air-wound inductor gives more watts out. 5x2x6".

Use any transceiver, solid-state or tube.

Operate all bands with one antenna.

2 OTHER 200W MODELS:

MFJ-901, \$59.95 (+ \$4), like 900 but includes 4:1 balun for use with balanced lines.

MFJ-16010, \$39.95 (+ \$4), for random wires only. Great for apartment, motel, camping, operation. Tunes 1.8-30 MHz.

MFJ-949B VERSA TUNER II



MFJ-949B
\$139⁹⁵ (+ \$4)

MFJ's best 300 watt Versa Tuner II.

Matches everything from 1.8-30 MHz, coax, randoms, balanced lines, up to 300W output, solid-state or tubes.

Tunes out SWR on dipoles, vees, long wires, verticals, whips, beams, quads.

Built-in 4:1 balun. 300W, 50-ohm dummy load. SWR meter and 2-range wattmeter (300W & 30W).

6 position antenna switch on front panel, 12 position air-wound inductor; coax connectors, binding posts, black and beige case 10x3x7".

MFJ-962 VERSA TUNER III



MFJ-962
\$229⁹⁵ (+ \$10)

Run up to 1.5 KW PEP, match any feed line from 1.8-30 MHz.

Built-in SWR/Wattmeter has 2000 and 200 watt ranges, forward and reflected.

6 position antenna switch handles 2 coax lines (direct or through tuner), wire and balanced lines.

4:1 balun. 250 pf 6KV cap. 12 pos. inductor. Ceramic switches. Black cabinet, panel.

ANOTHER 1.5 KW MODEL: MFJ-961, \$189.95 (+ \$10), similar but less SWR/Wattmeter.

MFJ-10, 3 foot coax with connectors, \$4.95.

MFJ-984 VERSA TUNER IV

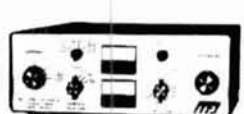

MFJ-984
\$329⁹⁵ (+ \$10)

Up to 3 KW PEP and it matches any feedline, 1.8-30 MHz, coax, balanced or random.

10 amp RF ammeter assures max. power at min. SWR. SWR/Wattmeter, for ref., 2000/200W.

18 position dual inductor, ceramic switch.

7 pos. ant. switch. 250 pf 6KV cap. 5x14x14".

300 watt dummy load. 4:1 ferrite balun.

3 MORE 3 KW MODELS: MFJ-981, \$239.95 (+ \$10), like 984 less ant. switch, ammeter.

MFJ-982, \$239.95 (+ \$10), like 984 less ammeter, SWR/Wattmeter. MFJ-980, \$209.95 (+ \$10), like 982 less ant. switch.

MFJ-989 VERSA TUNER V



MFJ-989
\$329⁹⁵ (+ \$10)

New smaller size matches new smaller rigs — only 10 3/4x4 1/2x14-7/8D".

3 KW PEP. 250 pf 6KV caps. Matches coax, balanced lines, random wires 1.8-30 MHz.

Roller inductor, 3-digit turns counter plus spinner knob for precise inductance control to get that SWR down.

Built-in 300 watt, 50 ohm dummy load.

Built-in 4:1 ferrite balun.

Built-in lighted 2% meter reads SWR plus forward/reflected power. 2 ranges (200 & 2000W).

6 position ant. switch. Al. cabinet. Tilt bail.

To order or for your nearest dealer

CALL TOLL FREE 800-647-1800

For tech. info., order or repair status, or calls outside continental U.S. and inside Miss., call 601-323-5869.

- All MFJ products unconditionally guaranteed for one year (except as noted).
- Products ordered from MFJ are returnable within 30 days for full refund (less shipping).
- Add shipping & handling charges in amounts shown in parentheses.

Write for FREE catalog, over 80 products

MFJ ENTERPRISES, INCORPORATED

Box 494, Mississippi State, MS 39762



CHICAGO AMATEURS HAVE WON AN ANTENNA RESTRICTION FIGHT. A new ordinance would have permitted the installation of radio communications towers and satellite receiving dishes only as part of a "planned unit development" and would have required a special use permit as well. There are no current height limitations in that city covering Amateur installations, but had local hams not acted quickly, the ordinance could have meant a sudden death to new Amateur growth there, as well as having been a bad precedent which other cities might have copied.

Chicago Hams Quickly Organized under attorney Jim O'Connell, W9WU. They deluged their aldermen with telephone calls and letters, and on February 25th, O'Connell appeared at a City Council meeting. Near the close of that hearing an amendment was introduced, by the bill's original sponsor, which would exempt antennas and towers erected by federally licensed Amateur Radio operators from the ordinance proposal. O'Connell felt that Amateur Radio would probably receive the needed exemption.

TRANSMITTERS CAUSING INTERFERENCE IN THE 440-MHZ REGION have been T-Hunted down by Santa Barbara, California, Amateurs. These devices, which may be either locators for off-shore oil drilling or "sounders" for oil exploration, were noted to cause RFI as far as 60 miles away. At least one of these transmitters was found on a U.S. Coast and Geodetic Survey concrete benchmark along the Southern California coastline, completely unattended. Some Amateurs feel these devices may pose a public safety hazard in addition to disrupting UHF communications.

Another Site, 30 miles from the first, was discovered quite by accident. This time, however, a frequency near 1.6 MHz was being used. Both "boxes" bore labels written in French, and each appeared to transmit digital data signals in two distinct modes. Measurements made by Amateurs also indicated these units produce spurious radiation in the 980-MHz region when switching modes.

What Is Not Known is to whom these units belong and what purpose they serve. The FCC has reportedly been informed of their existence. At least one unverified rumor claims these are but two of several such devices that will eventually run the length of both coastlines.

A ONE TIME EXCEPTION IS BEING MADE BY THE FCC regarding the renewal of club and military recreation station licenses. If you held such a license and it expired between March 11, 1977, and July 14, 1980, you can file for renewal before June 1, 1982, and have the request granted. Not included are repeater WR prefix callsigns, even if one was your club's call. As far as the FCC is concerned, WR callsigns for repeaters is a dead issue.

THE COMMISSION HAS DENIED a Petition for Reconsideration on its recent relaxation of the Amateur identification rules (P.R. Docket 80-136). The petitioner wanted a change in the wording of the new I.D. rules but the FCC ordered the new rules to stand as implemented. Also denied were RM-3137, which would have raised the power limits on parts of the 2-meter and 3/4-meter bands up to 2 kilowatts dc (in order to encourage more EME communications); and RM-3181, a proposal to reduce legal power limits of hf radiotelegraphy from 1 kilowatt to 250 watts.

A NOTICE OF PROPOSED RULE MAKING AND A NOTICE OF INQUIRY concerning the expansion of radiotelephony on the hf bands has been issued by the Commission. P.R. Docket 82-83 specifically addresses radiotelephone expansion on 20 meters, while the NOI deals with methods to be used to implement such an expansion, along with the question of additional phone expansion throughout the hf spectrum. The FCC did note that there had been seven petitions in regard to the subject, and that while all were in general agreement concerning the 20-meter proposal, there was a wide divergence of views about other hf phone allocations. The comment cutoff date is July 1st, with reply comments due August 2nd.

REGION I OF THE IARU HAS ALREADY FILED IN OPPOSITION to the ARRL proposal for expansion of U.S. radiotelephone privileges below 14.2 MHz, stating that permitting U.S. Amateurs (who would be running high power and directional antennas) into that spectrum would adversely affect the operation of foreign hams who run low power and very basic equipment. They also noted the decline in sunspot activity which in turn is leading many Amateurs away from 15 and 10 meters and onto 20. Region I feels that an influx of high-power U.S. stations could make Amateur operations in other parts of the world impossible, thus causing some to move their phone operations into the CW segment of the band. The shared use of portions of 20 meters by some European government and fixed services was noted as well.

ORBITAL SCHEDULES for Oscar 8 and for the UOSAT (Oscar 9) are available from ARRL headquarters for an SASE with "one unit of first-class postage attached." Send your request to the Club and Training Department, ARRL, 225 Main St., Newington, CT 06111.

electronic mail
aerospace
press
satellite
training aids
embassy/diplomatic
maritime
government
emergency/disaster
meteorological
oceanographic
handicapped
civil defense

CONSIDER THE ATR-6800

You know of its reputation in Amateur Radio. But did you know of its world-wide uses in commercial/industrial communications networks? ATR-6800's are communicating over land-lines, via satellite, and on HF/VHF radio links all over the world. They're teaching Morse Code on military bases around the country and operating as TELEX & TWX terminals. We offer engineering expertise for your particular requirement be it Data Encryption, Computerized Training or any special interest. ATR-6800 with 9" video monitor and one plug-in Applications Module . . . \$2495. Companion MX-80 printer . . . \$699. Contact the "REAL-WORLD" at MICROLOG CORP. 18713 Mooney Drive, Gaithersburg, Md. 20879. TEL: (301) 258-8400. TELEX: 908153. You'll be pleasantly surprised.



MICROLOG
INNOVATORS IN DIGITAL COMMUNICATION

a quad owner switches

Which is the better antenna, quad or Yagi? Read this dialogue to find out why a well-known ham switched to Yagis after using a quad for years.

Thousands of words have been published about the relative merits of cubical quads and Yagi antennas, and probably millions of hours have been spent in on-the-air debates of the matter.

Quad proponents claim their square-shaped, three-dimensional antennas have more gain than Yagis do — perhaps as much as 2 dB more. To support their contention, they point to various studies of the two antenna types. But on the other hand, Yagi boosters claim there is little or no difference in the performance of the two antenna types — and they can point to research supporting their contentions.

This article will never settle such a long-standing controversy, but it does tell an interesting story about the experiences of one ham who became frustrated with his quad and switched to Yagis. Probably lots of people have become frustrated and replaced

one kind of antenna with another, but this ham took the trouble to actually measure the gain of his old and new antennas under controlled conditions. What he learned should be of interest to others who want a big signal but are limited to a single tower on a city lot.

Our story is about Dave Bell, W6AQ, the motion picture producer who made "The Ham's Wide World," "Moving Up to Amateur Radio," and most recently "The World of Amateur Radio." An avid DXer, he installed a large multi-element quad on a 70-foot self-supporting tower at his Hollywood Hills home. The quad had a 27-foot boom, with three elements on 20 meters, four elements on 15, and five elements on 10. The quad design is a popular one that has appeared in the *ARRL Handbook* and *ARRL Antenna Book* for many years.

Based on the often-quoted finding that a quad delivers the gain of a Yagi 1.8 times its boom length,¹ Dave was hoping to come out even with nearby DXers using Yagis up to, say, 48 feet long. But years of slugging it out in the pileups convinced him the quad just wasn't delivering that kind of gain. Sometimes, in fact, the big quad came out second best to small trap tribanders in the Los Angeles area:

The painful decision to scrap the quad actually

By Wayne Overbeck, N6NB, and Dave Bell, W6AQ, c/o California State University, Fullerton, Department of Communications, Fullerton, California 92634

came when my friend Bernie, W6PJX, took me in a long-path pileup into Europe. He's using a TH3 (a three-element tribander) with a reflector that tilts as if a 60-pound owl crash-landed on it. That indignity, plus being regularly bested on 20 by TH6s (also tri-band Yagis), forced me to hear what my pals had been telling me. My razor sharp mind started counting alternatives to the quad — alternatives that would fit on a 50-foot-wide lot. Let's see, there's the Yagi and...

A major manufacturer (Hy-Gain) had just announced a new line of five-element monoband Yagis with relatively short booms — antennas that could be stacked on Dave's existing tower without creating an excessive windload or a neighborhood revolution. A "Christmas tree" stack of these close-spaced Yagis is about as big an array as most Amateurs on a city lot could swing, Dave felt. So he ordered the new Yagis.

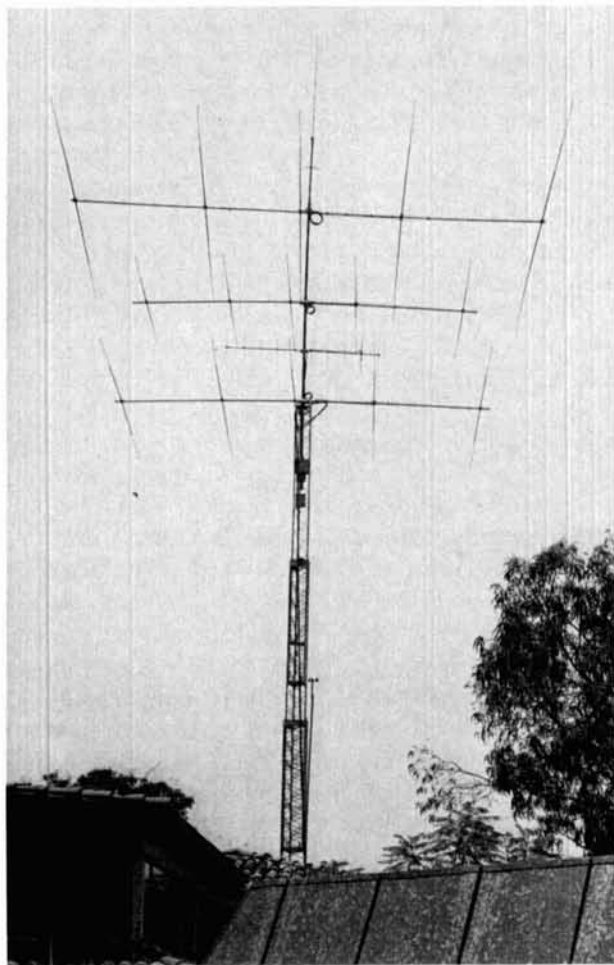

The new stack of monoband Yagis at W6AQ; they work great, but don't look up at them from the patio below! (See text.)

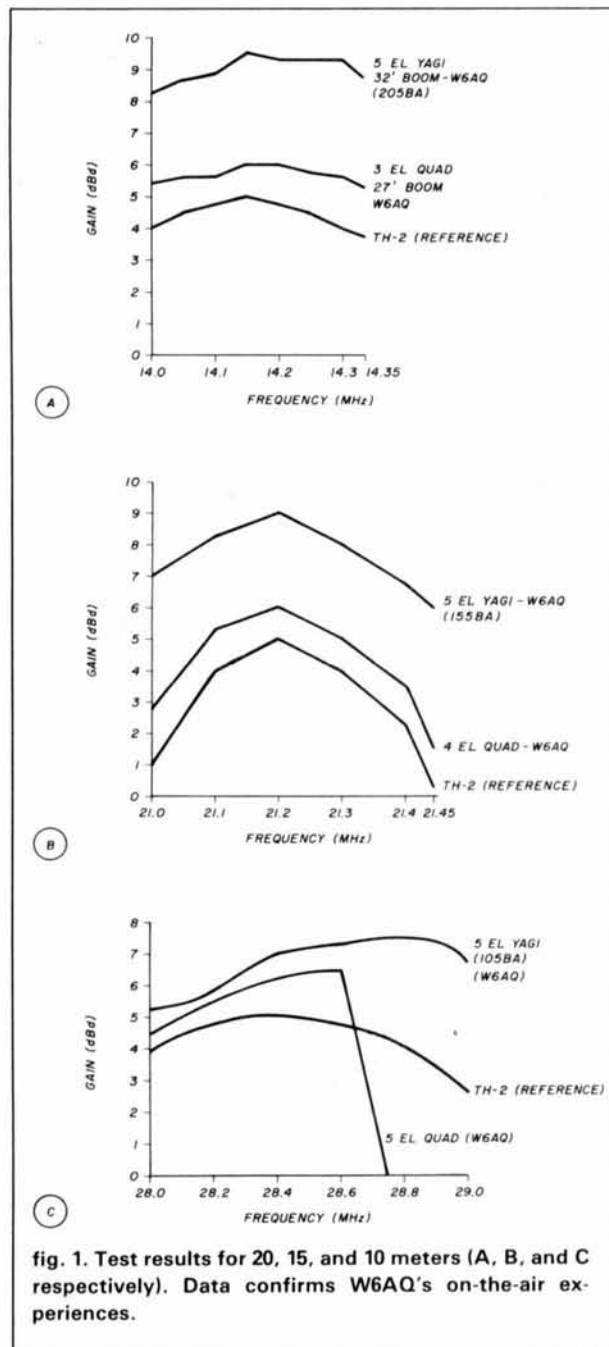

fig. 1. Test results for 20, 15, and 10 meters (A, B, and C respectively). Data confirms W6AQ's on-the-air experiences.

the gain measurements

Before Dave took down the big quad, we measured its forward gain on all three bands, using the techniques described in two previous articles.^{2, 3} Briefly, the technique involved placing a reference antenna (a small two-element tribander) atop a trailer-mounted 70-foot tower beside Dave's antennas.

In these tests, a station about 20 miles away (but

clearly line of sight from Dave's hilltop location) provided a steady signal for gain comparisons between the quad and the reference antenna at various points across the 10, 15, and 20 meter bands. The relative gain of the two antennas was measured and recorded, using a Drake R-4C receiver with the AGC turned off and an audio decibel meter reading the output.

The quad was then taken down and replaced with the three close-spaced Yagis. The 20-meter beam was placed on top, with the 10 in the middle and 15 on the bottom of the stack, using 7.5 foot vertical separation between antennas:

The 20-meter Yagi is on the top of my stack for two reasons: 1) It's the first one Hy-Gain got into production and consequently the first one I put up; 2) The twenty ought to be the farthest from the ground,

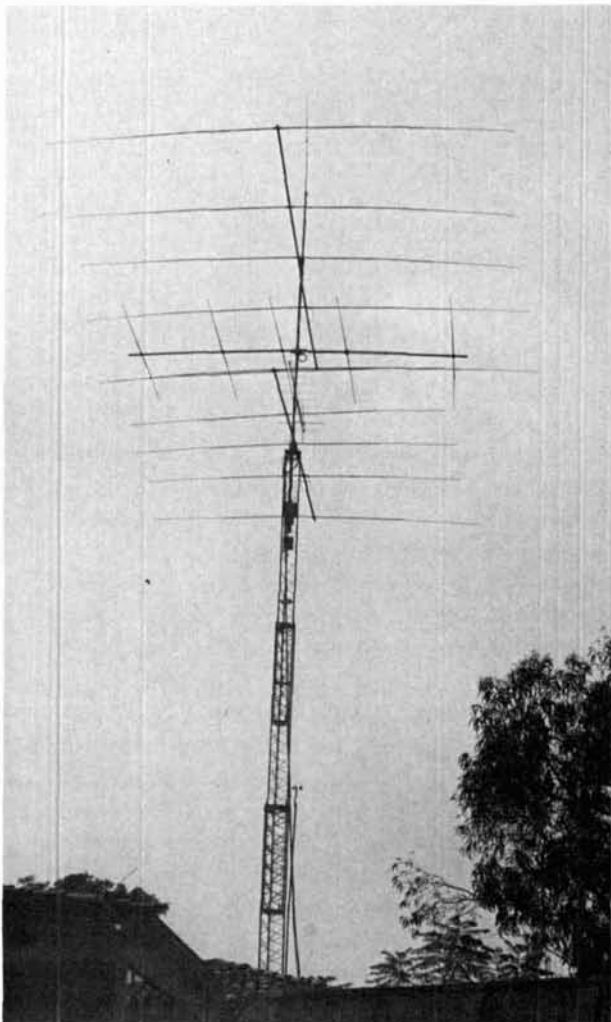

The final stacking arrangement, with the 10-meter Yagi at a right angle to the others. This configuration produced more gain on 10 meters than the in-line arrangement, but is it really 2-dB down in beauty?

I think, though I get kidded about it. I called Kit Kitterer at Hy-Gain to ask his opinion of the twenty on top and he said that was the obvious place for it but their ads showed it in typical Christmas tree fashion because that arrangement was more esthetically pleasing. (I know it's heresy, but I don't think antennas are measurable in terms of esthetics.) The 10-meter antenna was next to arrive, so it went on the tower next, and finally the 15-meter beam arrived and there you have it.

Even discounting any new antenna owner's anticipation of better results, I got and am getting far better on-the-air reports with the new Yagis.

There is only one complaint I can voice about the Hy-Gain stackables, as they call them. It is somewhat unsanitary to sit beneath them inasmuch as the birds, who never cared for my quad, are absolutely in love with all of those straight branches I put up for them. When walking beneath my Christmas tree, the best advice is, don't look up.

To verify Dave's on-the-air observations about the relative superiority of the new Yagis, we repeated the gain measurements, using exactly the same hardware and test procedure as with the quad. The portable tower was positioned in the same place and the same reference antenna was used, with the same station providing the test signal again. The reference antenna was even stored indoors during the interval between tests to assure that its performance would not deteriorate. The only thing different during these second tests was that a stack of Yagis was now on Dave's tower where the big quad had been. Dave even measured the new coaxial cables against the old:

A friend of mine came upon a lot of new RG-213 at a bargain, so I of course bought some to use with the new Yagis. When I realized that it would present a variable in Wayne's measurements, I measured its loss. When the four-year-old RG-8 came off the quads, I measured its loss too. Predictably, the 213 and RG-8 were identical at 28 MHz. The old coax is feeding a pair of two-meter antennas and my low band wires now.

To standardize the height of each new antenna at the 70-foot boom height used in the prior tests, Dave's tower was lowered for the tests of the 20- and 10-meter Yagis, which were 15 and 7.5 feet, respectively, up the mast from the top of the tower. Thus each Yagi was measured at exactly the same height as the old quad.

The results of the test, shown in **fig. 1**, were no surprise to Dave because of his on-the-air experiences, but the extent to which the Yagis outperformed a quad of about the same size surprised everyone else.

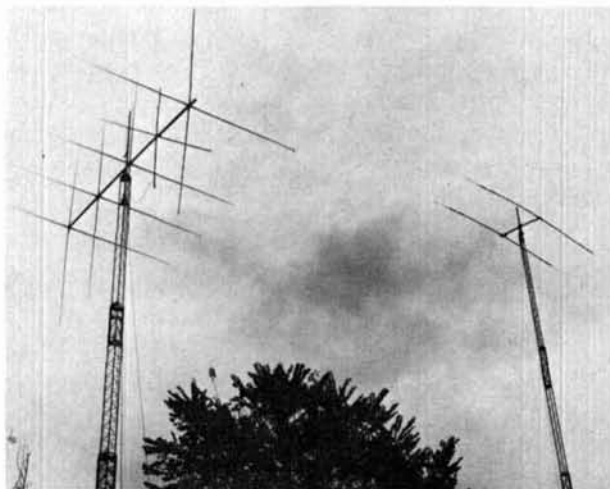

Replica of W6AQ's quad set up for testing at N6NB. After careful pruning, its gain improved but still didn't match the gain of several Yagis that were tested on the same tower.

the results

At every single frequency where a reading was taken, the Yagis were superior to the quad, often dramatically so. On both 15 and 20 meters, the Yagis were typically 3 dB better than the quad. That makes as much difference as doubling the transmitter power output!

The 10-meter Yagi also outperformed the quad, but by a lesser margin, apparently due to interaction problems. The 10-meter Yagi's gain fell considerably below the manufacturer's specifications, while the measured gain of the 15- and 20-meter arrays was close to specifications (thus lending credibility to those specifications, especially since the original prototypes were undoubtedly measured in the clear; that is, unstacked). But we wondered if the 10-meter beam was performing as it should, even though it exhibited a good SWR and nearly 30 dB of front-to-back ratio.

To find out, we rotated the 10-meter beam 90 degrees on the mast, turning its boom to a right angle in relation to the 15- and 20-meter booms. Re-measuring the gain without changing anything else, we found that the 10-meter antenna's gain had increased almost exactly 1 dB all across the band. Obviously, there were — and probably still are — interaction problems on 10.

To show you that the demon antenna expert is really just a pussycat, after measuring 1 dB or so better gain when the 10-meter beam was swung 90 degrees, Wayne suggested we swing it back into line!

I couldn't believe it! "It'll gain at least 2 dB in beauty," he explained. "Humbug," said I, and the 10-meter beam remained pointed off in its own direction, louder and prouder.

Another surprising thing we discovered in the 10-meter tests was that the quad's gain abruptly fell off above 28.7 MHz. Up to that frequency, the quad's gain was close to that of the Yagi and it exhibited a seemingly normal front-to-back ratio (about 20 dB). But suddenly the quad's gain plunged downward; its gain was nearly 15 dB below the reference tribander at 29.0 MHz! However, rotating the quad revealed an incredible phenomenon: the quad had nearly 20-dB back-to-front ratio above 29.0 MHz. The reflector had ceased to function as such, and the first director had become a reflector!

My face is red, but I have my excuses in place. First of all, ten was basically deserted during the four-year period that I used the quad. Second, I rarely operate above 28.7. Third, my inherent laziness allows me to work stations "off the back" if signal levels are mutually acceptable.

Little did I know that in my case "off the back" could have been better than "off the front" since I never observed that curiosity. Had I done so I probably would have chalked it up as a long-path contact, though I doubt there are many long-path openings between L. A. and Detroit.

Frankly, I can't imagine the cause of the quad's not knowing which end was which unless mother nature took her toll on my solder joints and gremlin capacitances hexed the poor old wire monster.

repeating the experiment

Dave's quad was a faithful reproduction of a very popular design — one that has appeared in many editions of the ARRL publications. Several well-known DXers with years of antenna-building experience had helped build Dave's quad. Did they incorrectly measure the elements on all bands? Or had old age set in? Was there really something wrong with Dave's quad, or could this be viewed as an indictment of quads in general?

As we looked at the data, it was apparent Dave's quad wasn't performing as well as would be expected on any band — not just on 10 meters where it abruptly developed backward directivity halfway up the band. And it seems unlikely the elements were mismeasured on all three bands.

Then was the quad badly mistuned? Perhaps, but nowhere does the ARRL Handbook description of the antenna say the dimensions given may not work, and that each antenna must be individually tuned if it is to work correctly. If every cubical quad must be individually tuned after it is installed, whereas Yagis can be simply cut to published dimensions, that would be a real disadvantage of quad antennas.

To explore some of these questions, we built another cubical quad identical to Dave's, very care-

fully cutting the elements to the dimensions given in the *ARRL Handbook*. We put it atop the trailer-mounted 70-foot tower and placed the reference TH-2 beside it on another 70-foot tower. Since a variety of other antennas had already been measured in this test configuration, we could compare this new quad against a variety of different Yagis, both monobanders and tribanders.

When we put up the replica of Dave's quad, it was not resonant anywhere near the proper place in any band. In all instances, the elements turned out to be much too long in our installation, resulting in backward directivity much like that observed on 10 meters with Dave's quad. Using SWR plots made with the antenna at its full height as an indicator of resonance, we gradually shortened each driven element until it was resonant near the middle of the appropriate band.

Next, we calculated the *percentage* longer or shorter that the reflectors and directors were supposed to be with respect to the driven elements, using the *Handbook* dimensions. The result was an antenna that faithfully reproduced the *design concept* of the *Handbook* quad: the reflectors and directors were the same percentage longer and shorter than the driven elements as in the original design, although the actual dimensions of all the elements were much shorter than those given in the *Handbook*. In working with wire antennas, we have often found that the correct dimensions for a given frequency may vary somewhat from those published, depending on the size and type of wire, whether the wire is bare or covered, etc.

Once we had completed these adjustments, we got good results — but not as good as some cubical quad devotees would predict. Across the 20-meter band, the quad averaged about 1 dB less gain than a similar-size four-element Yagi that we had tested on the same 70-foot tower in the same place, using the same feedline and the same TH-2 as a reference (with the TH-2 also in the same place). On 15, the quad was consistently 2 dB down from a five-element Yagi we'd tested on the same tower. And on 10, the quad was about 0.5 dB down from a five-element Yagi — until we reached the frequency where the quad reversed its directivity. At that point, its gain dropped many, many dB below the Yagi's. In both on-the-air tests using skip signals and local measurements of directly radiated signals, we found the quad to be an excellent triband antenna, but no match for monoband Yagis of the same size.

Ah, you say, but this was a comparison of a triband quad against monoband Yagis and therefore unfair to the quad. To find out how well the quad would work as a monobander with elements for just one band, we tested it as a five-element 10-meter

quad (that is, with the 15- and 20-meter elements removed). The extra elements made virtually no difference: if anything, the quad was a little better on 10 meters with the 15- and 20-meter elements than without them, although the resonant frequency was a little lower with the extra elements. Even as a monobander, the quad still didn't match the gain of a similar size Yagi.

conclusion

What does all of this prove? Well, it suggests that Dave's quad wasn't working quite as well as it should have been. With patience and pruning, it could have been made to work a little better, but probably not as well as his new Yagi stack.

And that, really, was what Dave's experiment was all about: he wanted to know which antenna system is the best bet for someone who lives on a typical city-size lot as he does. Monster long-boom antennas (either quads or Yagis) were out of the question, but a stack of Yagis with relatively short booms was feasible — as was a multi-element quad. And Dave found out the stack of Yagis was the better performer.

Shortly after we finished testing the second version of the *Handbook* quad, Jim Lawson's article based on computer analyses of quads and Yagis appeared in *ham radio*.⁴ Lawson concluded that an ideal long-boom quad might deliver up to half a dB more gain than a similar size Yagi, but that in the real world, optimizing a cubical quad may be so difficult as to make this theoretical gain advantage illusory. (Lawson also pointed out that tuning any big antenna near the ground is a sure way to guarantee that it will *not* be correctly tuned at its working height. If you want to optimize a quad, be prepared to repeatedly raise and lower it — or borrow someone's "cherry picker.")

Our field tests of quads and Yagis have produced much the same conclusion as Lawson's theoretical analyses. In years of measuring the gain of quads and Yagis, we have yet to find any long-boom quad in the real world that performs as well as an equal size Yagi.

We don't claim any of this settles the quads-versus-Yagis controversy for all time, but neither do we suggest that you try to hold your breath until Dave Bell switches back to a cubical quad!

references

1. Lindsay, "Quads and Yagis," *QST*, May, 1968, page 11.
2. Wayne Overbeck, N6NB, "Measuring Antenna Gain with Amateur Methods," *QST*, October, 1977, page 11.
3. Wayne Overbeck, N6NB, "Quads and Yagis Revisited," *ham radio*, May, 1979, page 11.
4. James L. Lawson, W2PV, "Yagi Antenna Design: Quads and Quagis," *ham radio*, September, 1980, page 37.

ham radio

Introducing incredible tuning accuracy at an incredibly affordable price: The Command Series RF-3100

31-band AM/FM/SW receiver.* No other shortwave receiver brings in PLL quartz synthesized tuning and all-band digital readout for as low a price.† The tuner tracks and "locks" onto your signal, and the 5-digit display shows exactly what frequency you're on.

There are other ways the RF-3100 commands the airways: It can travel the full length of the shortwave band (that's 1.6 to 30 MHz). It eliminates interference when stations overlap by narrowing the broadcast band. It improves reception in strong signal areas with RF Gain Control. And the RF-3100 catches Morse



RF-6300 8-band AM FM SW

communications accurately with BFO Pitch Control.

Want to bring in your favorite programs without lifting a finger? Then consider the Panasonic RF-6300 8-band AM/FM/SW receiver (1.6 to 30 MHz) has microcomputerized preset pushbutton tuning, for programming 12 different broadcasts, or the same broadcast 12 days in a row. Automatically. It even has a quartz alarm clock that turns the radio on and off to play your favorite broadcasts.

The Command Series RF-3100 and RF-6300. Two more ways to roam the globe at the speed of sound. Only from Panasonic.

*Shortwave reception will vary with antenna, weather conditions, operator's geographic location and other factors. An outside antenna may be required for maximum shortwave reception.

†Based on a comparison of suggested retail prices.

This Panasonic Command Series™ shortwave receiver brings the state of the art closer to the state of your pocketbook.



With PLL Quartz Synthesized Tuning and Digital Frequency Readout.

Panasonic
just slightly ahead of our time.

dipole antenna over sloping ground

Even slightly uneven ground
beneath your antenna
can have a big effect
on the pattern

Charts in numerous publications show the elevation patterns of a horizontal dipole at various heights above ground. These patterns assume perfectly conducting *flat* ground. For horizontally polarized waves, the perfectly conducting ground is normally a good assumption. But for those who don't live over *flat* terrain, is the effect of uneven or sloping earth significant?

A friend who lives on a hill informed me that, of his three antennas at 35, 50, and 100 feet (10.6, 15, and 30.5 meters) the lower-height antenna gave consistently better results on 10-meter DX. I therefore decided to investigate the effects of sloping ground under an antenna. The results are quite interesting.

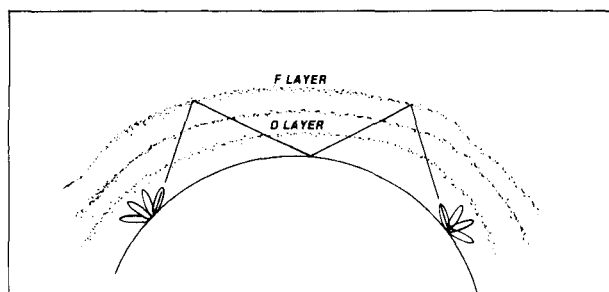

fig. 1. Dipole located at a height above ground which results in an elevation pattern that matches the arrival wave angle.

optimum wave angle

The ideal antenna system will be optimized in performance by placing the antenna at a height above the ground that will match the vertical elevation angle to that of the propagation wave, as in **fig. 1**. It has been found that the vertical wave angle for a New Jersey-to-London path is inversely proportional to frequency¹ (see **table 1**). Note that the mean vertical wave angle is 22 degrees on 40 meters, 11 degrees on 20 meters, 7 degrees on 15 meters, and 5 degrees on 10 meters.

A possible cause for higher vertical wave angles being useful at lower frequencies is D-layer absorption. This absorption, which is more significant at lower frequencies, increases at lower vertical wave angles because the signal travels further within the D layer. Since D-layer absorption is a function of ionization level, the wave on low frequencies may favor higher angles in the daytime. Also, for a given ionization-layer height, shorter-range communications involve higher vertical wave angles. Lawson² discusses useful wave angles. Good data on optimum vertical wave angles for DX Amateur communications for varying diurnal, seasonal, and solar cycles and frequencies is sorely needed.

dipole over flat ground

To find the vertical wave angle of a horizontal dipole over flat ground, see **fig. 2**. The dipole at height, h , above the ground has an image antenna an equal distance below ground. The reflected wave may be considered as emanating from this image antenna. The reflection from ground of a horizontally polarized wave also introduces an additional 180-degree phase shift. The incoming direct and reflected waves arrive at points A and B in the same phase, since they are both on the advancing plane-wave front. The reflected wave must advance the addi-

By Randy Rhea, N4HI, 4414 Brockett Creek Drive, Tucker, Georgia 30084

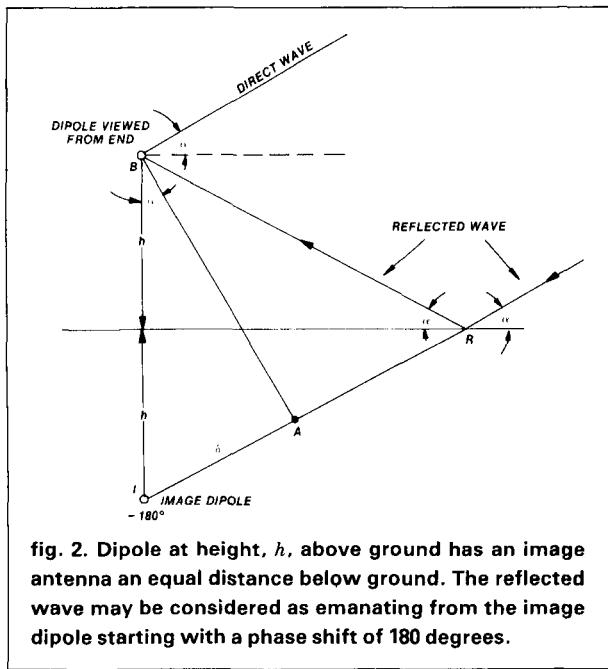

tional distance from A to the image antenna and therefore suffers additional phase shift plus the 180-degree reflection. Therefore, the two waves *don't arrive in phase*.

There are certain elevation angles, α , for a given antenna height that will result in the extra path length, δ , being 180 degrees. This 180 degrees will add to the reflected 180-degree phase shift and result in the two waves adding in phase, which will cause a maximum in the elevation pattern. Additional maxima will occur when $\delta = 540$ degrees, 900 degrees, 1260 degrees, and so on. (For a mathematical derivation of this effect, refer to Appendix 1.) The total phase shift, Δ , is equal to $\delta + 180$ degrees:

$$\Delta = 2h \sin(\alpha) + 180^\circ \quad (1)$$

This equation can be solved for h in terms of Δ and α :

$$h = \frac{\Delta - 180^\circ}{2 \sin(\alpha)} \quad (2)$$

By setting $\Delta = 360$ degrees (first maximum of the pattern) and α equal to the optimum vertical wave angle for each frequency band, the optimum antenna height for each band can be determined.

When α from the measured data of the London-to-New Jersey path is used, an interesting result occurs. The heights for 40 through 10 meters are 240, 472, 738, and 1033 electrical degrees respectively. The electrical height, h_e , of the antenna may be converted to the physical height in feet, h_f , by the relationship

$$h_f = \left(\frac{h}{360}\right) \left(\frac{984}{f}\right) \quad (3)$$

where f is the frequency in megahertz. This results in optimum antenna heights of 94, 92, 96, and 101 feet (28.7, 28, 29, and 30.8 meters) for 40 through 10 meters respectively. The inherent uncertainties of the variables and the pattern width involved don't warrant specifying the height to the nearest foot, but the interesting fact is that heights of 90 to 100 feet match quite well useful wave angles for 40 through 10 meters.

dipole over tilted ground

A dipole over sloping ground is shown in fig. 3. The dipole is at a height, h , above the ground immediately below the antenna, at the base of a vertical supporting structure. The true electrical height, h_e , is slightly less and is the distance from the antenna at B to the ground along a line perpendicular to the ground.

The image antenna also lies on the perpendicular line at a distance h_e below ground. The first effect of tilted ground, therefore, is to lower the effective height of the antenna. This effect is rather small, however.

A large ground tilt of 11 degrees reduces the effective height of an antenna 100 feet (30.5 meters) high by only 1.8 feet (0.5 meter). A much more significant factor is the effect on the reflection angle at R of the ground tilt. For a mathematical derivation of the additional phase shift, Δ , refer to Appendix 2. The formula for phase shift is shown in eq. 4.

table 1. Arrival wave angle from England to the New Jersey coast (from reference 1).

frequency (MHz)	angle below which signals arrived 99% of the time (degrees)	angle above which signals arrived 50% of the time (degrees)	angle above which signals arrived 99% of the time (degrees)
7	35	22	10
14	17	11	6
21	12	7	4
28	9	5	3

$$\Delta = 2h \cos(\gamma) \sin(\alpha - \gamma) + 180^\circ \quad (4)$$

Solving this equation for h in terms of Δ , α , and γ , we have

$$h = \frac{\Delta - 180^\circ}{2 \cos(\gamma) \sin(\alpha - \gamma)} \quad (5)$$

Now consider what happens when even a small ground slope of +3 degrees exists. Using again the same wave angles of **table 1**, $\Delta = 360$ degrees for the first maximum; and solving for the optimum height, h , we have 108, 126, 168, and 252 feet (33, 38, 51, and 77 meters) for 40 through 10 meters. As can be seen, the effect of tilted ground is very significant. The effect on the lower frequencies is less pronounced because of the higher wave angles. The higher-frequency bands require that the antenna be much higher than when over flat terrain. The effect of a downward slope of 5 degrees, or $\gamma = -5$ degrees is also significant.

Optimum antenna heights are 78, 64, 56, and 51 feet (24, 20, 17, and 16 meters) for 40 through 10 meters. It seems that the combination of a location on a hill plus a high antenna can be detrimental: too much of a good thing.

patterns

Determining the elevation pattern of the dipole over ground from the phase shift of the reflected wave is straightforward. The direct wave is defined as 1 volt at 0 degrees, or $1/\underline{0}$ in polar form. The reflected wave is 1 volt at Δ degrees, or $1/\underline{\Delta}$ in polar form. The total voltage resulting from both waves is then $1/\underline{0} + 1/\underline{\Delta}$. Converting each of these to rectangular form and adding, we have:

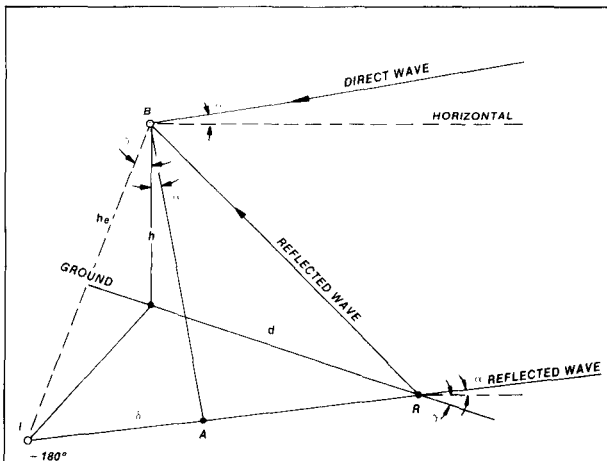

fig. 3. Dipole at height h above sloping ground. The slope of the ground, γ , is negative for ground below the horizon in the direction of propagation. The elevation wave angle, α , is still referenced to the horizon. The height is the length of a vertical supporting tower.

$$\frac{1 + j0}{1 + \cos \Delta} + \frac{j \sin \Delta}{j \sin \Delta} \quad (6)$$

and then converting back to polar form,

$$E = \sqrt{(1 + \cos \Delta)^2 + \sin^2 \Delta} \angle \tan^{-1} \left(\frac{\sin \Delta}{1 + \cos \Delta} \right) \quad (7)$$

The absolute magnitude of the total voltage

$$|E| = \sqrt{(1 + \cos \Delta)^2 + \sin^2 \Delta} \quad (8)$$

may be rewritten

$$|E| = (\sqrt{2})(\sqrt{1 + \cos \Delta}) \quad (9)$$

The E-field (horizontal) pattern that results varies from a maximum of 2 to a minimum of zero as the direct and reflected waves add and cancel in phase.

To calculate the actual gain of a dipole over ground, the effects of the mutual impedance of the dipole and its image must be taken into account.³ For antennas high above ground, this effect is small. The relative E-field patterns found by the previous procedure are not affected by the mutual impedances.

The elevation patterns of a dipole antenna at 95 feet (29 meters) over flat ground are given in **table 2**.^{*} The first maxima of each is shown in **fig. 4**. Notice how well the patterns match the optimum

^{*}In the following text, **tables 2, 3, and 4** refer to computer printouts. Copies of these tables may be obtained by sending a self-addressed, stamped business size envelope to *ham radio*, Greenville, New Hampshire 03048.

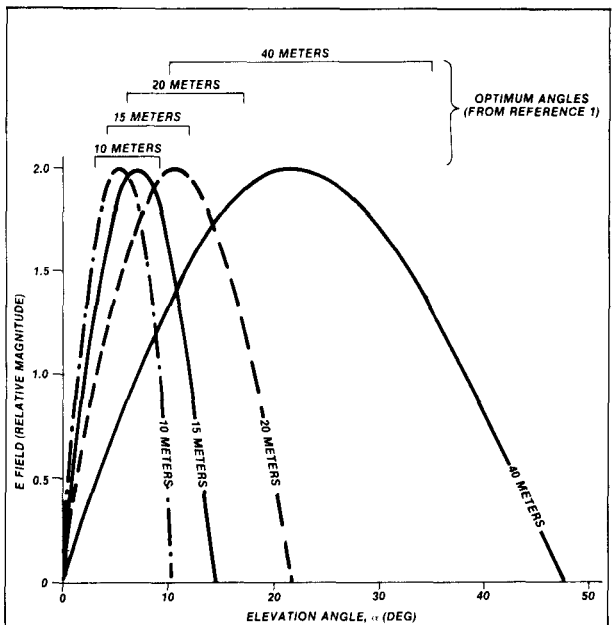

fig. 4. First maxima of the elevation pattern of a dipole 95 feet (29 meters) above flat ground for 40 through 10 meters. Notice how well the maxima match the optimum wave angles as shown in **table 1**.

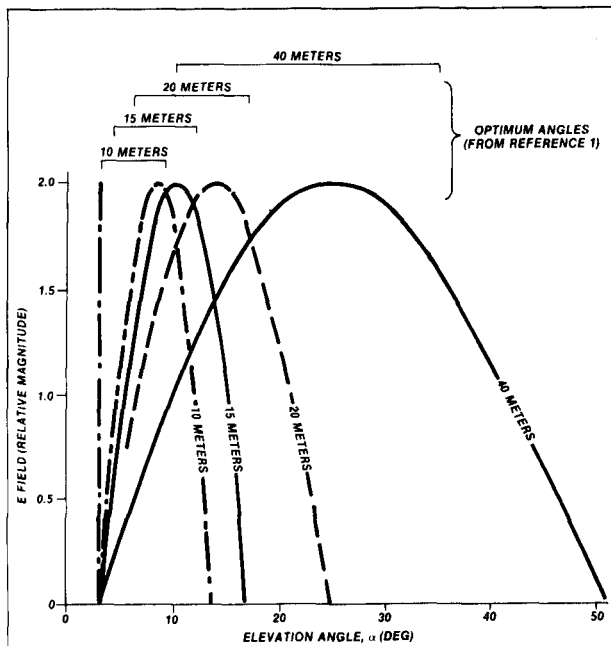

fig. 5. First maxima of the elevation pattern of a dipole 95 feet (29 meters) above ground with an upward slope of 3 degrees for 40 through 10 meters. Notice the misalignment of the maxima and the optimum wave angles, particularly at higher frequencies.

wave angle¹ on each band. The elevation patterns of a dipole 95 feet (29 meters) above ground for 40 through 10 meters (ground sloping upward 3 degrees toward the incoming wave) are given in table 3 and fig. 5 and in table 4 and fig. 6 over ground sloping downward -5 degrees. Notice the severe misalignment of the wave angle and the elevation pattern for both cases.

reflection point

The distance, d , from the base of the dipole's tower to the reflection point is

$$d = h \left[\frac{\cos \gamma}{\tan(\alpha - \gamma)} - \sin \gamma \right] \quad (10)$$

This is closely approximated by the simpler relationship

$$d \approx \frac{h}{\tan(\alpha - \gamma)} \quad (11)$$

where d and h are in the same units. For $h = 96$ feet (29 meters), $\alpha =$ the optimum angle for each band over level ground ($\gamma = 0$). For Amateur bands 40 through 10 meters, d equals 235, 489, 773, and 1086 feet (72, 149, 235.8, and 325.8 meters). The effect of ground tilt on the distance to the reflection point is most significant on the higher frequencies. For

$\gamma = -5$ degrees, the reflection point moves in to 539 feet (164 meters) on 10 meters and 186 feet (56.7 meters) on 40 meters. In estimating the effects of sloping ground at your location, it's usually necessary to take into account the location of the reflection point. If, for example, your antenna is on a hill or in a valley of an extent less than the reflection-point distances involved, with flat ground beyond, then the net effect of the hill or valley will be to raise or lower the effective height of your antenna.*

Yagi antenna over tilted ground

An excellent treatment of Yagis over flat ground is given by Lawson.² He also discusses the tilted Yagi over flat ground. The case of a horizontal Yagi (perpendicular to a vertical tower) over sloping ground is similar to a dipole over sloping ground. The largest effect of a Yagi in this case is that the magnitude of the pattern lobes is reduced at higher elevation angles. A high-gain Yagi will also lower, very slightly, the angle of the maxima.

Tilted ground under a Yagi will also fill in the nulls

*A program for RPN calculators is available that gives the E-field in increments of 2 degrees for the elevation pattern of a dipole over flat or tilted terrain. Send a self-addressed, stamped business size envelope to ham radio, Greenville, New Hampshire 03048, for a copy.

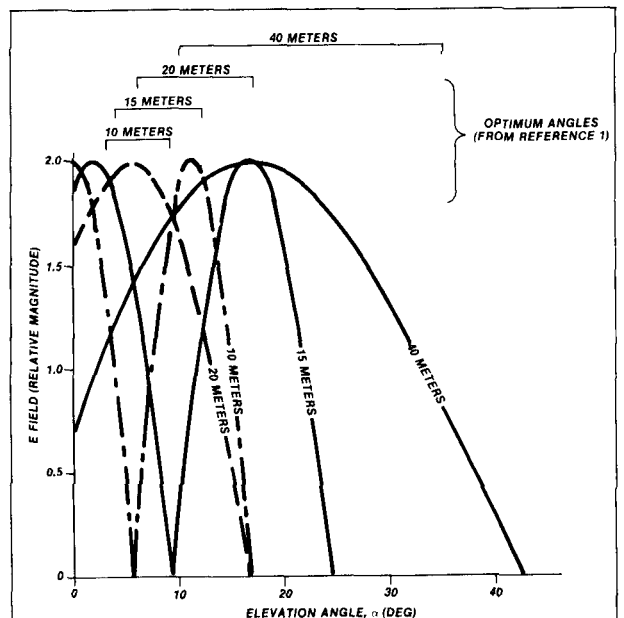

fig. 6. Low-angle maxima of the elevation pattern of a dipole 95 feet (29 meters) above ground with a downward slope of -5 degrees for 40 through 10 meters. Notice on 10 meters the misalignment is so severe as to actually have a null in the pattern at the desired wave angles.

in the elevation pattern, much like a tilted Yagi over flat earth. To understand why this is so, refer to **fig. 3**. Note that the direct and reflected waves arrive at the antenna at point B at different angles. Therefore, the free-space elevation pattern of the Yagi will reduce somewhat the voltage of the reflected wave impressed upon the terminals of the Yagi as compared with that impressed by the direct wave. The two waves *do not* have equal amplitudes. Therefore, even when phase cancellation occurs, complete cancellation of the voltage *does not* occur. This effect is most pronounced on high-gain Yagis with fairly large ground slopes.

acknowledgment

I'd like to thank John Hollis, Jr., WA4QLL, for writing the computer programs and preparing the tables of E-field elevation patterns. John and I have had many interesting conversations on antennas over sloping ground and we have run over-the-air tests investigating this effect.

references

1. The ARRL Antenna Handbook, 13th edition, ARRL, 1974, page 18.
2. Jim Lawson, "Yagi Antenna Design: Ground or Earth Effects," *ham radio*, October, 1980, pages 29-37.
3. J.D. Kraus, *Antennas*, McGraw Hill, 1950, page 305.

appendix 1

Refer to **fig. 2**. Since *A* and *B* lie on the plane wave front of the incoming wave, *BAI* is a right triangle. Angle *IBA* is equal to the elevation angle. The hypotenuse of the right triangle is *2h*. Therefore,

$$\sin(\alpha) = \frac{\delta}{2h} \quad (\text{A1})$$

and then

$$\delta = 2h \sin(\alpha) \quad (\text{A2})$$

The total phase shift must include the reflection 180 degrees, so

$$\Delta = 2h \sin(\alpha) + 180^\circ \quad (\text{A3})$$

appendix 2

Refer to **fig. 3**. Again *BAI* is a right triangle. Angle *IBA* is equal to α plus γ . Since γ was chosen as negative for the downtilt configuration of **fig. 3**,

$$\text{angle } IBA = \alpha - \gamma \quad (\text{B1})$$

The effective height of the antenna, h_e , is

$$h_e = h \cos(\gamma) \quad (\text{B2})$$

therefore,

$$\delta = 2h \cos(\gamma) \sin(\alpha - \gamma) \quad (\text{B3})$$

The total phase shift is

$$\Delta = 2h \cos(\gamma) \sin(\alpha - \gamma) + 180^\circ \quad (\text{B4})$$

ham radio

NOW!

HAL Communications Is Proud To Announce That Our Amateur Radio Products Are Being Stocked At The Following Leading Amateur Dealer Stores:

EASTERN UNITED STATES:

AMATEUR ELECTRONICS SUPPLY
28940 Euclid Ave.
Wickliffe, OH 44092
(216) 585-7388

ELECTRONICS INTERNATIONAL SERVICE CORP.
11305 Elkin Street
Wheaton, MD 20902
(301) 946-1088

MIDWEST UNITED STATES:

AMATEUR ELECTRONICS SUPPLY
4828 W. Fond du Lac Ave.
Milwaukee, WI 53216
(414) 442-4200

DIALTA AMATEUR RADIO SUPPLY
212 - 48th Street
Rapid City, SD 57701
(605) 343-6127

ERICKSON COMMUNICATIONS
5456 N. Milwaukee Avenue
Chicago, IL 60630
(312) 631-5181

HAM RADIO CENTER
8340-42 Olive Blvd.
St. Louis, MO 63132
(314) 993-6060

THE HAM SHACK
808 N. Main St.
Evansville, IN 47711
(812) 422-0231

UNIVERSAL AMATEUR RADIO
1280 Aida Drive
Reynoldsburg, OH 43068
(614) 866-4267

WESTERN UNITED STATES:

AMATEUR ELECTRONICS SUPPLY
1072 N. Rancho Drive
Las Vegas, NV 89106
(702) 647-3114

CW ELECTRONICS
800 Lincoln Street
Denver, CO 80203
(303) 832-1111

HENRY RADIO, INC.
2050 S. Bundy Dr.
Los Angeles, CA 90025
(213) 820-1234

SOUTHERN UNITED STATES:

ACK RADIO SUPPLY COMPANY
3101 4th Ave. South
Birmingham, AL 35233
(205) 322-0588

AGL ELECTRONICS
13929 N. Central Expwy
Suite 419
Dallas, TX 75243
(214) 699-1081

AMATEUR ELECTRONIC SUPPLY
621 Commonwealth Ave.
Orlando, FL 32803
(305) 894-3238

AMATEUR ELECTRONIC SUPPLY
1898 Drew Street
Clearwater, FL 33515
(813) 461-4267

AMATEUR RADIO CENTER
2805 N.E. 2nd Ave.
Miami, FL 33137
(305) 573-8383

BRITT'S TWO-WAY RADIO
2508 N. Atlanta Rd.
Belmont Hills
Shopping Center
Smyrna, GA 30080
(404) 432-8006

GISMO COMMUNICATIONS
1039 Latham Drive
Rock Hill, SC 29730
(803) 366-7157

MADISON ELECTRONICS
1508 McKinney Ave.
Houston, TX 77010
(713) 658-0268

N & G DISTRIBUTING CORP.
7201 N.W. 12th Street
Miami, FL 33126
(305) 592-9685

RAY'S AMATEUR RADIO
1590 US Highway 19 South
Clearwater, FL 33518
(813) 535-1414

Call Or Stop-In And See HAL Equipment At Your Favorite Amateur Dealer.

Write today for HAL's latest RTTY catalog



HAL COMMUNICATIONS CORP.

Box 365
Urbana, Illinois 61801
217-367-7373

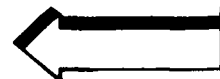

CT2100

HAL Puts MORE Behind The Buttons

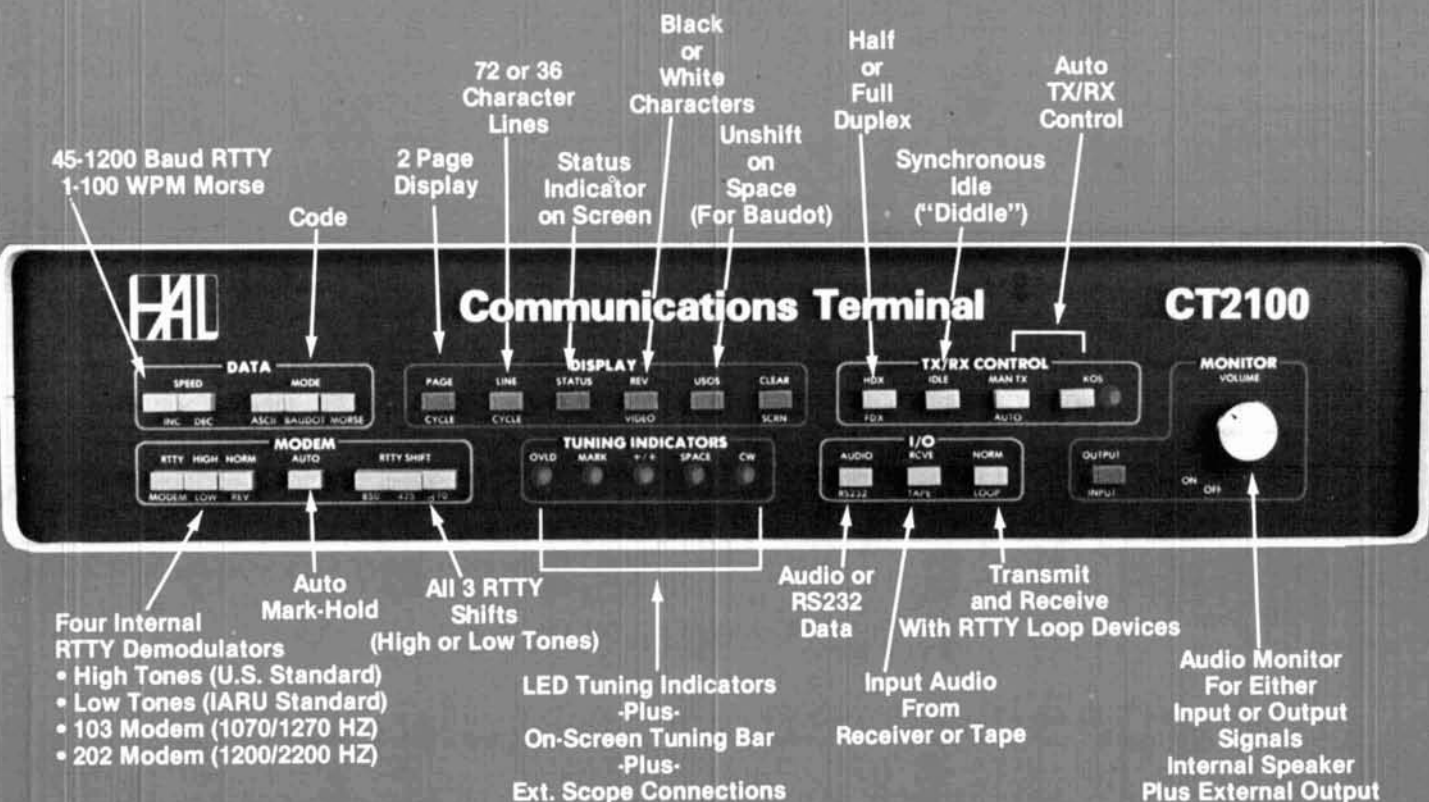

CT2100 System:

- CT2100 Communications Terminal
- KB2100 Keyboard
- Video Monitor
- Printer (300Bd Serial ASCII-MPI-88G)
- RM2100 Rack Adapter
- MSG2100 2000 Character "Brag Tape" ROM

- 24 Line Display
- 2 Pages of 72 Character Lines
- or-
- 4 Pages of 36 Character Lines
- Split Screen (with KB2100)

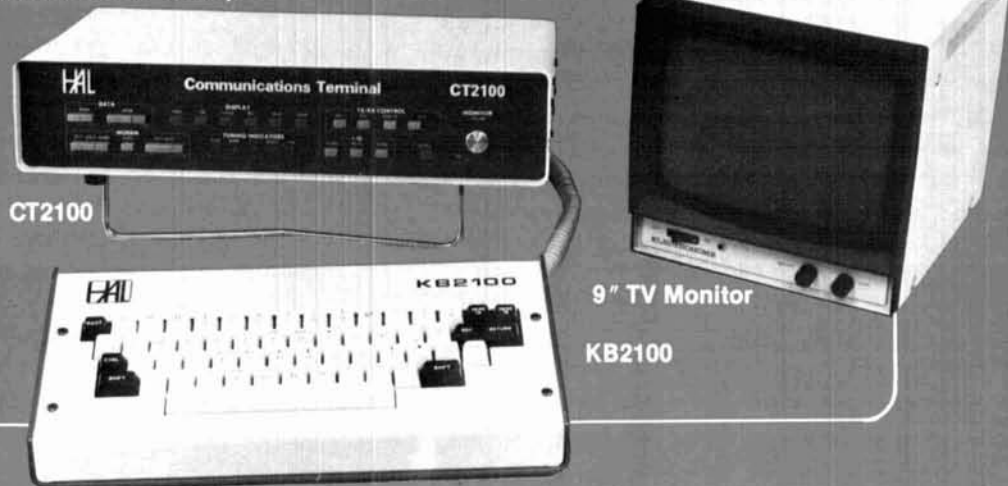

HAL COMMUNICATIONS CORP.
Box 365
Urbana, Illinois 61801
217-367-7373

NOW! HAL Equipment is in stock at leading Amateur Dealers.

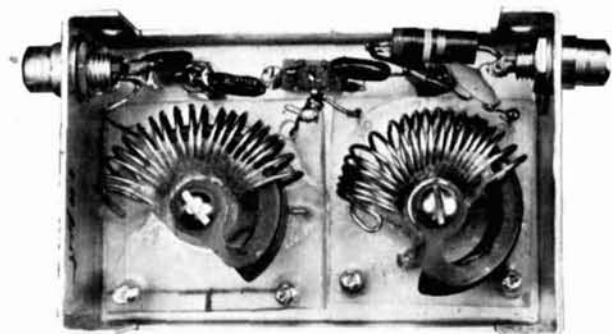

inductance-tuned lowpass antenna matching unit

An experimental design
for low-power transmitters

This article is meant to raise more questions than it answers, because it is about a subject where many questions still need to be answered.

It's interesting to review the history of antenna matching in the design of manufactured final amplifiers. I remember working an old Johnson Viking In-

vader into loads with SWRs as great as 5:1. Later vacuum-tube equipment was good for loads with SWRs up to only 2:1. But note what all the manufacturers are selling us now: solid-state finals with no panel controls. Great — but suppose the load doesn't look exactly like 50-ohms resistive? You're putting out less power, or the safety relay opens up altogether. So obviously you may need an outboard gadget for your compact rig: an antenna-matching network, which is available from numerous manufacturers, usually called a "transmatch."

These commercial transmatches are usually copies or modifications of the original circuit by W1ICP¹ as "The Ultimate Transmatch." Its circuit is shown in fig. 1a. Variable capacitors C1a and C1b are ganged. Amateurs soon discovered that C1b did not contribute to a match: the basic circuit of fig. 1b works just as well. Virtually all rf matching networks except transformers are also filters, however, which may be lowpass, bandpass, or highpass configurations. It's evident that the circuit of fig. 1b is a highpass T net-

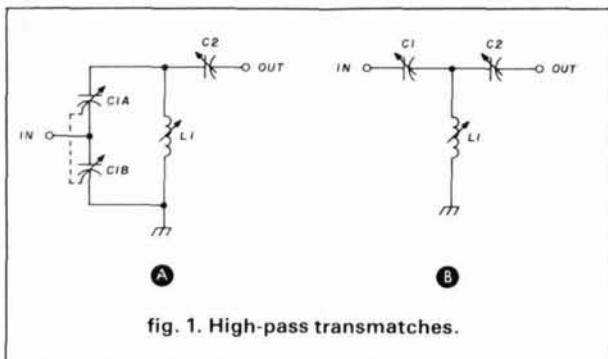

By Richard Silberstein, WØYBF, 3915 Pleasant Ridge Road, Boulder, Colorado 80301

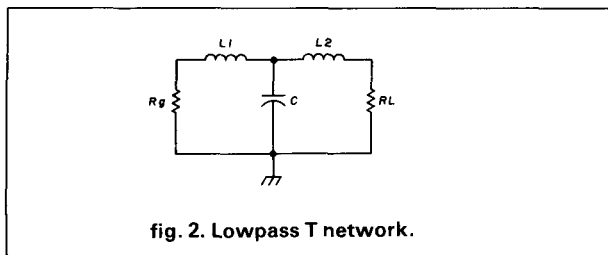

fig. 2. Lowpass T network.

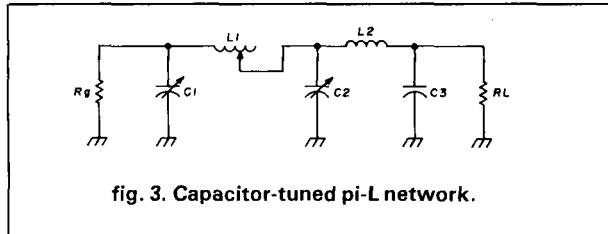

fig. 3. Capacitor-tuned pi-L network.

work. Such a circuit is just the opposite of what's needed to attenuate harmonics.²

With the prevalent highpass form of transmatch, one must rely for harmonic suppression entirely upon the lowpass untuned matching network built into the commercially manufactured transmitter's final amplifier, which is usually designed for a 50-ohm resistive load. Obviously, harmonics would be better suppressed if one could use a lowpass T as in fig. 2.

There is a practical problem of how to tune lowpass networks. In the original transmatch of fig. 1, most of the tuning is done by variable capacitors C1 and C2. When the mismatch is not very great, inductor L1 is varied only for band changing, taps and a rotary switch with grounded arm being used. Now in the case of the lowpass T, this design has been unpopular because of the difficulty of tuning inductors continuously over a wide range of values,³ or even of step-switching them at a high-voltage point above ground, which makes construction more difficult. These facts apply even in the case of the old-fashioned conventional lowpass pi network. However, JA6GW⁴ has succeeded in building a lowpass T high-power antenna-matching network to handle SWRs of up to 3:1 on three bands. Referring to fig. 2, C is continuously tuned, L1 is untuned and L2 is step tuned.

lowpass experimental network

My objective was to design a lowpass tuned network for a QRP (low-power) portable transmitter that would match antennas under the variety of SWR conditions I was to meet, and, at the same time, would suppress unwanted frequencies sufficiently to eliminate the need for the fixed-tuned 50-ohm transmitter output network altogether. My first design

was a capacitor-tuned pi, followed by a fixed-L network for additional harmonic suppression, as in fig. 3. To keep the equipment small I used for C1 and C2 small imported 365-pF variable capacitors with polystyrene dielectric. Such capacitors proved to be relatively unsatisfactory because of contact jitter, especially under salt-air conditions.⁵

The obvious direction to move lay in using something like a lowpass T and tuning L1 and L2 (fig. 2). I had previously simplified the half-toroid powdered-iron-vane tuned inductor made by K1KLO and described by W1CER in a low-power version of the original transmatch.^{6,7} The photograph in the 1976 article shows that K1KLO apparently cemented one cut edge of his half-toroid core to a flat piece of metal, which was joined to the shaft collar. This was the core's sole support. As the shaft was turned for tuning, the core penetrated by varying amounts into the half-toroid coil.

The main advantage of K1KLO's design is that, with its thin support, the core can be turned almost 180 degrees. The disadvantage is that the support end of the core must be machined precisely at right angles to its plane. Thus the designer is pretty well limited to the use of powdered iron cores. This limitation is satisfactory for oscillator design, because temperature drift of permeability is so much worse in ferrite cores. However, for tuned-radio-frequency stages in receivers, the temperature change of permeability is usually of little importance, so that one can take advantage of the greater tuning range afforded by inserting ferrite cores into a coil. The same is true of tuned inductors in transmitter-matching networks, except for the important fact that a ferrite core saturates easily. Core problems are discussed further at the end of the article.

variable inductor

My simplified design of a variable inductance³ entails the use of a flat sickle with central hub made from fiberglass-epoxy resin circuit board with the copper etched off. The half-toroid core is glued to the blade part of the sickle, and the hub is screwed to the end of the tuning shaft. With this technique the ends of the toroid do not have to be machined, thus making it possible to use ferrites.

Contrary to popular belief, an attempt to split an expensive ferrite toroid core need not end in disaster. A method that works well is to lay a straight-edge across the middle of the core, separating it into two equal parts. A pencil is used to mark the ferrite ring at the two places where the straight-edge crosses. Then use the edge of a small triangular file to saw along the pencil lines. Sawing from below the original line and at the sides of the ring helps. It's usually not necessary to saw very far before the core breaks.

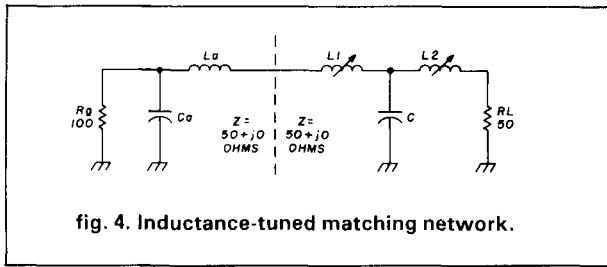

fig. 4. Inductance-tuned matching network.

The break may be slightly jagged, but not sufficiently so to make the core unusable. In stubborn cases, gripping each half of the core (protected by masking tape) in a small portable vise and striking a blow to one half, or to a chisel along the filed slot, should be considered. Yes, one toroid core does supply two tuning units.

The advantage of using ferrites can be appreciated by noting that one of my experimental units using Amidon FT 114-63 material at 10 MHz exhibited an inductance ratio of 5.9 to 1 between tuning extremes.

design considerations

The theory of matching networks is very much of an electrical-engineering specialty. Fortunately, however, tables exist for values of circuit elements for matching a variety of sources to a fixed load of 50 ohms, there being a table for each of several choices of Q and each of four basic matching circuits, with equations given.^{8,9,10}

In this design I've not attempted to provide an optimum result but rather to show that an improved design is feasible, leaving the full job as a challenge to the more capable Amateur. It's relatively easy to design a circuit with tuned-inductance series arms and fixed-parallel capacitors for a 50-ohm resistive match with a chosen Q . If the inductive arms have a large tuning ratio, one can design for the 50-ohm match values toward the middle of the tuning range and accept the range of load matching made possible by adjustment of the inductance values. For my portable operations this was not an unsatisfactory proce-

sure, since I was using resonant, but sometimes loaded, monopoles and doublets. In the worst cases, the monopole ground plane might consist of only one wire laid along the railing of a motel balcony, or a doublet might be suspended very low above ground. I generally don't try to load up arbitrary lengths of wire. I especially avoid resonant wires with feed points close to a voltage maximum.

experimental circuit

The network I finally came up with was more of a mongrel than I had originally intended. It started out as the T network of fig. 2 with a Q of 4 and switchable shunt capacitors for changing from 14 to 21 MHz, matching an assumed 100-ohm resistive output to a 50-ohm resistive load. I found the information shown in table 1 by using reference 8 and making approximations. However, I wasn't able to use the original T network because, apparently, the inductance of rf chokes in the transmitter final amplifier caused a parasitic oscillation at about 4 MHz. This oscillation was eliminated by placing a 100-pF capacitor across the transmitter output.

table 1. Computed values for proposed T network of fig. 1; initial data used from reference 8 ($Q = 4$, $R_G = 100$ ohms, $R_L = 50$ ohms).

f (MHz)	X_{L1} (ohms)	L1 (μ H)	X_{L2} (ohms)	L2 (μ H)	X_C (ohms)	C (pF)
14	400	4.6	287	3.3	174	66
21	400	3.0	287	2.2	174	44

The new circuit could be split and described as a number of different combinations. After examining published tables in reference 10, I chose to look at it as an approximation of fig. 4, an L network of $Q = 2$, transforming 100 ohms to a 50-ohm resistive load — the load being a symmetrical lowpass T network of $Q = 6$ with 50 ohms resistive output and input. Table 2 gives circuit parameters for 14 and 21 MHz.

Fig. 5 shows practical adaptation of fig. 4. The unit was connected to the output of a simple rf ferrite toroid transformer in the output circuit of a 2-3 watt transmitter for 14 and 21 MHz. For capacitor C2 I compromised on a single 100-pF silvered-mica unit. For tuning I used a 100-microampere meter in the transmitter to measure relative output. The 1N914 diode, CR1, provides a measure of peak rf output across itself. It charges C1 and C5. The discharge of C1 through R1 (470k) provides the current to give a relative reading on the meter. Resistor R2 is used as a means of draining atmospheric electrical charges off the antenna.

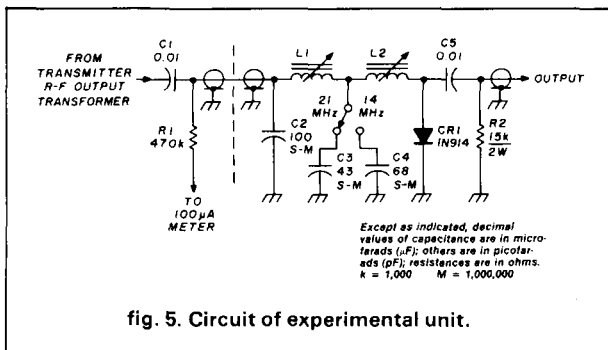

fig. 5. Circuit of experimental unit.

table 2. Computed values for circuit of fig. 4, approximated in final unit (data from reference 10). R_g is 100 ohms resistive; R_L is 50 ohms resistive.

f (MHz)	X _{Ca} (ohms)	Ca (pF)	X _{La} (ohms)	L _a (μH)	X _{L1} (ohms)	L1 (μH)	X _{L2} (ohms)	L ₂ (μH)	X _C (ohms)	C (pF)
	100		50		300		300		154	
14		110		0.58		3.4		3.4		74
21		70		0.39		2.3		2.3		49

tuning considerations

When one tunes for a maximum relative output voltage at CR1, this is essentially a measure of the voltage across the antenna cable and therefore a measure of the maximum output of the transmitter for a particular feed line and antenna, irrespective of SWR. One must assume, of course, that as a result of previous experience with the antenna, the SWRs are not unreasonable if amplitude readings and dial settings are similar to those that have been noted under controlled conditions with an SWR meter in the line. Self-oscillation of the final (not keyed in my transmitter) can usually be recognized as small key-up readings or readings without rf drive. VHF parasitics sometimes appear as very large meter readings. In one case when the antenna cable's shield was mostly torn from the plug, so that the final amplifier saw a load favorable for VHF oscillation, there was a very large apparent output reading at unusual tuning positions, but only during key down. An SWR meter showed very high readings.

construction

In the physical design of the unit, it was possible to build inductors with such a wide tuning range that no bandswitching of inductance was needed. In fact, L_a as seen from table 2 was so much smaller than L1 that I simply regarded it as a part of L1, which I then wound identical to L2.

I designed the matching unit to fit into a Bud aluminum minibox (natural finish) CU3017A or equivalent, 3-1/4 by 2-1/8 by 1-1/8 inches (83 by 54 by 29

mm). Fig. 6 shows the layout in the cover of the box. I mounted each inductor on an acrylic plate about 1-1/2 inches (38 mm) square. The central bushing is nylon 13/32 inch (10 mm) in diameter and 17/64 inch (6.7 mm) high, drilled for a standard 1/4 inch (6.4 mm) shaft of Formica. Using the techniques of reference 3, I cemented the bushings to the plates, which had oversized shaft holes.

For each half-toroid I wound twenty-two turns of No. 20 (0.8 mm) enameled wire on a 3/8 inch (9.5 mm) dowel, two more turns than would be used, because the coil would unspring slightly. A little more coil width would have allowed more core clearance in the finished product. I carefully wrapped this coil around the bushing, cementing twenty turns to the bushing and plate with Duro cement, having first brought leads out through holes in the plate. An rf-coil cement, Duco, or epoxy would all have done equally well. Holding the coil with a rubber band or small clamp until the cement hardens may be helpful.

For the cores, I split an Amidon 114-63 core as described above and in reference 3. It was necessary to use washers between the sickle hub and shaft end to space the core properly inside the coil with the shaft all the way into the nylon bearing. To hold each assembly in place I made shaft collars with set screws.

unwanted-output suppression characteristics

Fig. 7 shows the test setup for measuring unwanted-output levels relative to the level of the desired output. The low-power transmitter-matching circuit under test feeds a 50-ohm load of 8-watt dissipation, consisting of four 200-ohm, 2-watt resistors in parallel. This load is bridged by an arbitrary bleeder consisting of a 1000-ohm half-watt resistor in series with a 50-ohm half-watt resistor feeding a short piece of 50-ohm cable.* This cable can plug into one terminal of a precision variable rf attenuator; the one in this case was a unit once made by Hewlett Packard. I also used a high-frequency signal generator set arbitrarily at a high 50-ohm output level (mine was an old unit by Clemens Manufacturing Co.). Its output through 50-ohm cable can also plug alternatively into the attenuator terminal.

*For greater precision the capacitances across the resistors should be accounted for, as in the case of the attenuator in an oscilloscope rf probe.

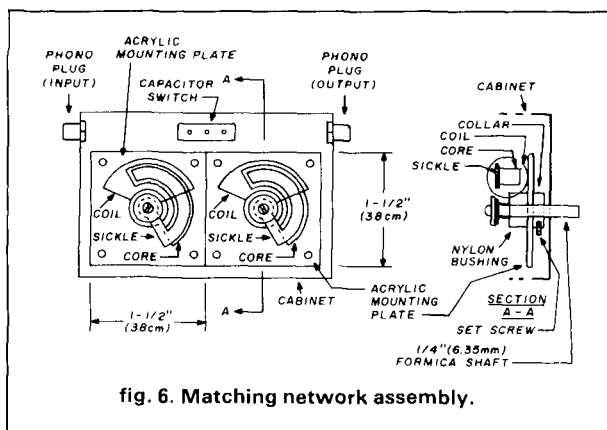
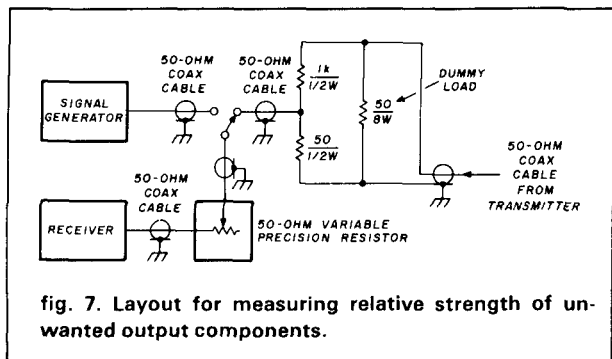

fig. 6. Matching network assembly.



The other terminal of the attenuator goes to a stable communications receiver with a good AGC meter (S-meter). Mathematically it can be demonstrated that when the cables are matched at the sending end (not necessarily at the receiver) on any one receiver frequency setting, the output from the bleeder fed through the attenuator, and that from the signal generator fed through the attenuator, are the same — except for attenuator settings when the AGC meter reads the same. Negligible cable losses are assumed.

The procedure for measuring relative unwanted output is as follows:

1. The bleeder output from the transmitter dummy load is put through the calibrated attenuator and a setting, A , made to give a convenient AGC-meter reading with the receiver resonated to the transmitter fundamental frequency. Setting A is noted.
2. The signal generator is now plugged into the attenuator instead, with at least 20 dB of its own 50-ohm attenuator in use (to make sure of having a 50-ohm source). It is tuned to the receiver and a new attenuator setting, B , is made to bring the AGC-meter needle to the same point as before. The setting is recorded. The receiver now shows that the signal generator output and the bleeder output are equal.
3. With the transmitter running again, a harmonic or other unwanted frequency is tuned in.
4. Again the transmitter bleeder output through the attenuator is adjusted on the attenuator dial to a new convenient AGC-meter reading. The new attenuator setting, A' , and the new meter reading are recorded.
5. Again a new signal-generator output (with its own attenuator unchanged from step 2) on the new frequency is put through the attenuator. The procedure of step 2 is followed, and attenuator setting B' for the AGC-meter reading of step 4 is recorded.
6. The number of dB that the signal generator was below the transmitter-bleeder output for the fundamental is $(A-B)$. The number of dB for the unwanted signal is $(A'-B')$, which may be negative, so the un-

wanted signal is $(A-B)-(A'-B')$ below the fundamental in decibels.

Table 3 shows the approximate results of the tests at 14 MHz.

some final observations

I've demonstrated that it's possible to build a simple tuned output network for a low-power rf final amplifier that has matched portable antennas in a variety of situations and is, at the same time, a lowpass filter with very satisfactory suppression of unwanted frequencies. However, as stated at the start, this achievement raises more questions than it answers.

In the first place the design, as mentioned above, was not optimized and I have not determined the exact range of loads that can be matched. Also, for the range of different possible settings, there must be a wide range of Q s, that I've not calculated. This is fair-to-poor ham practice, but terrible engineering. There's been a lot of theoretical research on matching networks and some practical engineering data published, but it appears that much more application information is needed.

The tables of matching-network parameters mentioned earlier are an example of good application information, but they are chiefly concerned with matching a fixed load, generally 50 ohms resistive. The mere question of how to express load-matching capabilities and limitations of a tunable multi-element circuit is a difficult one to answer. Standing-wave ratio is a convenient measure of a mismatch to be matched, yet anyone familiar with the Smith chart knows that any SWR circle intercepts a variety of circuit parameters and that it is these values that limit matching capabilities, not the SWRs.

Returning to fig. 2, for a given design one could superimpose parametric curves on a Smith chart — for instance, varying $L1$ with $L2$ and C being fixed. One could do this for different values of $L2$ and C . From these curves one could see limits of SWR and circuit parameters for a particular design. However, the real problem is to optimize a design, starting with expressed limits of loads to be matched. We have here a problem worthy at least of a Master's degree

table 3. Approximate attenuation of unwanted signals from low-power transmitter at 14 MHz fed through antenna-matching unit to 50-ohm resistive load. Transmitter final was push-pull 2N3948s.

f (MHz)	dB below wanted signal
28	55
42	70
7 (from VFO)	48

for some technically oriented engineering-school ham with skill in computer programming.

Then there's circuit Q , which will vary as the circuit is tuned. Does present textbook material do enough to relate the defined Q of a filter-circuit element to its overall Q , and how does this relate to the simple $\omega L/R$ of an LRC tank circuit so well explained in the textbooks? Then, what about the low Q s (some say not above 4) so frequently specified? The limitation here cannot be the passband as it is with vacuum-tube power-output circuits. I must guess that the higher- Q transistor-output circuits might tend to oscillate at some unwanted frequency where the matching circuit no longer matches but presents the collector circuit of the final amplifier with a load that would be favorable for oscillation — but I've not seen this in print. Passband characteristics involving harmonic suppression have been treated in various places. They must be of concern in an optimum design.

Finally there is the question of the behavior of the core. Ferrites saturate at a low magnetomotive force, but with a half-toroid we have a big air gap. Nevertheless, we should design for a large enough cross-section area to stay far below saturation. In fact, core nonlinearity produces harmonics that did not exist in the transistor output. To know where we stand relative to saturation requires knowledge of the rf current and the core position for each set of load parameters. High currents cause excessive heat, which will do permanent damage to a core.

Perhaps we should raise that proposed Master's degree to a Doctorate. I'm sure JA6GW already qualifies,⁴ but unfortunately he's shown us only part of his technique. It's quite likely, though, that experimentation alone will produce some useful, but not necessarily optimum, designs for higher-powered equipment than I've been using. Go to it, experimenters.

references

1. Lewis G. McCoy, W1ICP, "The Ultimate Transmatch," *QST*, July, 1970.
2. Doug DeMaw, W1FB, "Ultimate Transmatch Improved," *QST*, July, 1980 (Technical Correspondence), page 39.
3. R. Silberstein, W0YBF, "Variable-Inductance Variable-Frequency Oscillators," *ham radio*, July, 1980.
4. Bill K. Imamura, JA6GW, "A T-network Semi-Automatic Antenna Tuner," *QST*, April, 1980.
5. R. Silberstein, "Mobile from a Deck Chair," *Ham Radio Horizons*, August, 1979.
6. Doug DeMaw, W1CER, "Build a Baby Ultimate," *QST*, February, 1976.
7. Wes Hayward, W7ZOI, and Doug DeMaw, W1FB, *Solid State Design*, The American Radio Relay League, Inc., 1977.
8. *ARRL Electronics Data Book*, 1976. Includes tables with data up to $Q = 4$.
9. *Motorola Report AN-267*. One part by Frank Davis, "Matching Network Designs with Computer Solutions" has tables for four types of networks.
10. *Motorola RF Data Manual*, Motorola, Inc., First Edition, 1978. This comprehensive manual presents transistor data and application notes for transmitter design, and incorporates AN-267.

ham radio

UNADILLA/REYCO

HAM products that go the Dx.

Round after round of transmission, durable all-weather UNADILLA/REYCO baluns, traps and kits will take you the distance. Unadilla/Reyco will suppress feedline radiation and maximize antenna efficiency better than any competitive HAM line.

The Big Signal W2AU Balun gives you the right connection between any antenna and transmitter. The W2AU Balun can withstand 600 lbs. of pull, has a built-in lightning arrestor and can handle full legal power. For more than 20 years, it's been the choice of HAMS, Armed Forces and commercial communication around the world.

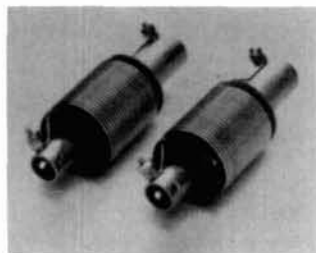
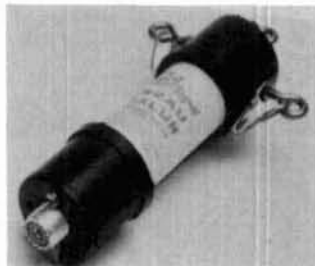

The Old Reliable W2VS Reyco Trap will always give you the perfect dipole. Professionals demand Reyco Traps because they're weatherized and can withstand 500 lbs. of pull. Developed by veteran HAM W2VS, Reyco Traps are paired by precision frequency.

The W2AU/W2VS 5-band Antenna Kit includes everything for low SWR on 40 and 80 meters, and resonants on 10, 15 and 20. The quality crafted components in this kit are time tested by HAMS around the world.

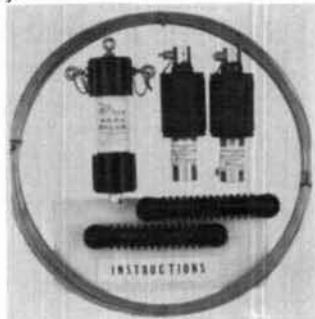

Other Unadilla/Reyco products include low pass filters, quad parts, insulators and endsulators. Call for our free catalog and the name of your nearest dealer. Hamfest managers: we cooperate. Remember: Unadilla/Reyco will take you the distance.

UNADILLA/REYCO

Division of Microwave Filter Co., Inc.

6743 Kinne St., East Syracuse, NY 13057

Toll Free 1-800-448-1666

TWX 710-541-0493

NY/HI/AK/Canada (collect) 1-315-437-3953

FOREIGN HAMS

LONDON: AMCOMM 01 804 1166/VICTORIA: Scalar 725 9677/PUNTA ARENAS: Novedades Rasmussen 22327/BUENOS AIRES: Multi-Radio 773-1266/COL. ANAHUAC: Radiac 2-50-32-40/France: SFL (90) 5339 40 (90) 611258



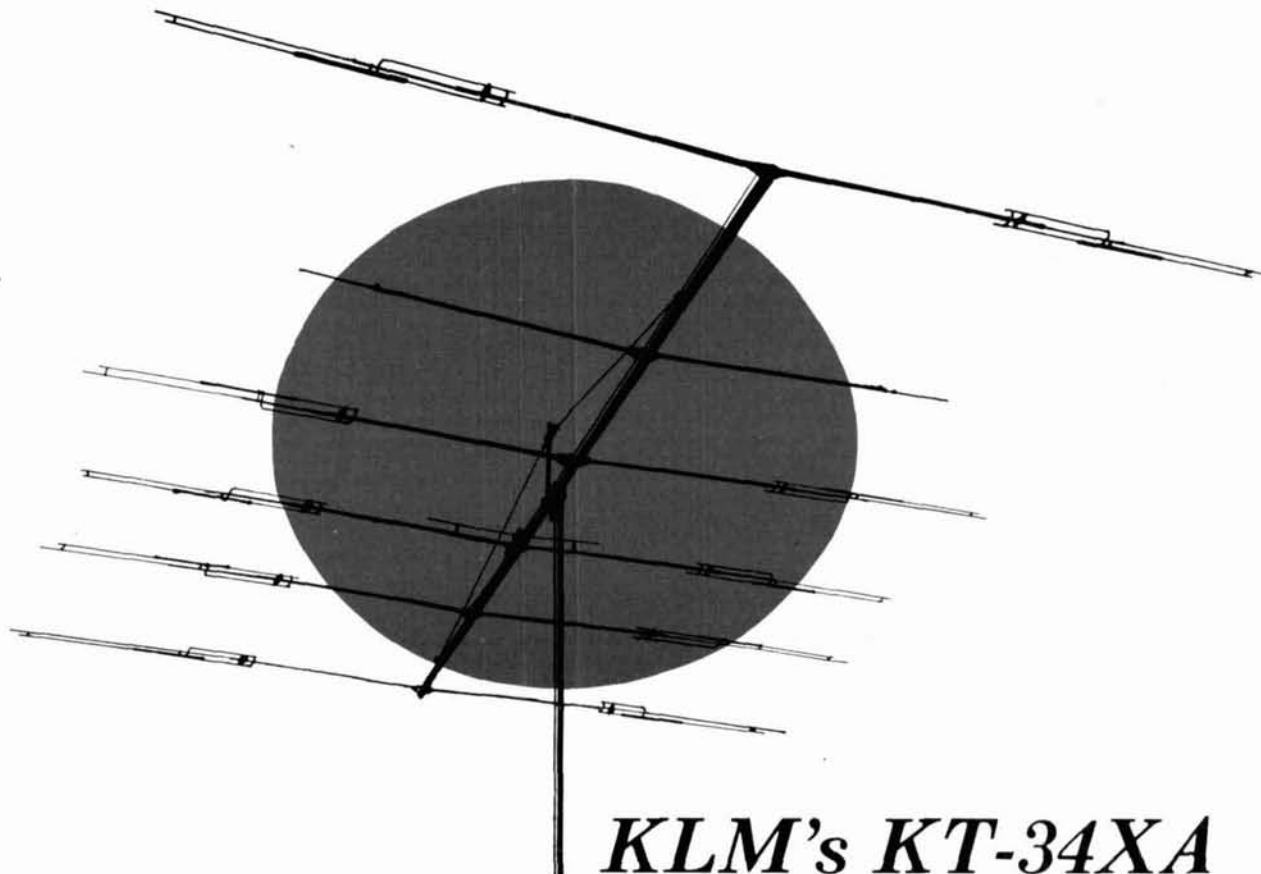

KLM's KT-34XA

Outperforms **ALL** commercially available tribanders and many monobanders, too!

KLM's KT-34XA TRIBANDER is the 2nd generation of a unique new series of antennas designed to provide superior **broadband** coverage on 20, 15, and 10 meters. The combination of lossless linear loading and hi-Q air capacitors enables the KT-34XA to outperform **all** commercial available tribanders and meet or exceed the performance of a conventional stacked monoband system. The lower weight and windload of a single antenna mean reduced tower and rotator requirements. Thus, overall system costs can be kept to a minimum while enjoying the best of monobander-type performance.

KLM's field proven KT-34A is the heart of the "XA" model. The boom length of the "XA", however, has been doubled, and one tri-resonant and one full size 10 meter element have been added. These changes increase the gain to **11-11.3 dBd** on 10M, **9-9.5 dBd** on 15M, and **8.5-9 dBd** on 20M. Two driven elements are used to make the KT-34XA unusually broadband (a concept applied to many KLM antennas). Gain is virtually flat across each band except for 10 meters which has been optimized for the DX'er, 28-29 MHz. The chart below shows the remarkable performance qualities of the KT-34XA.

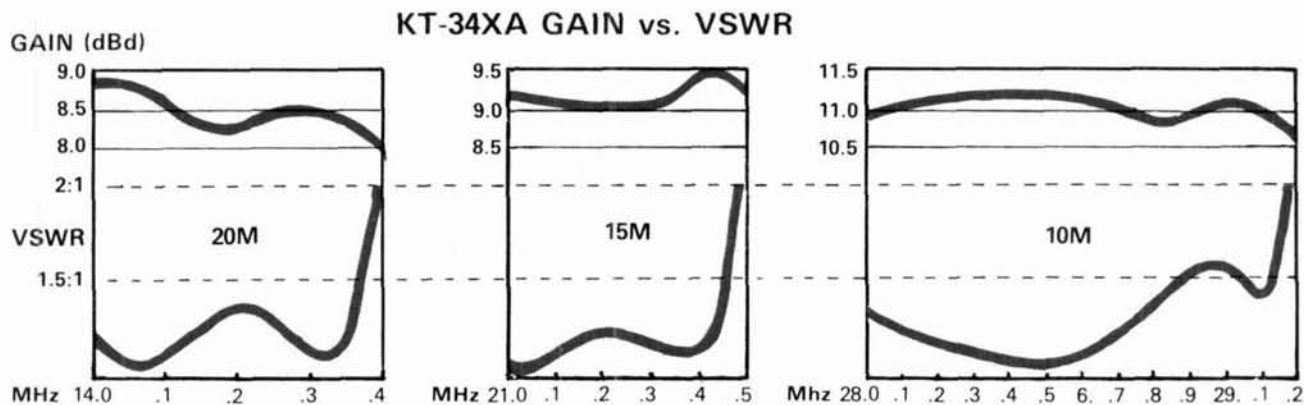

KLM

P.O. Box 816, Morgan Hill, CA 95037
(408)779-7363

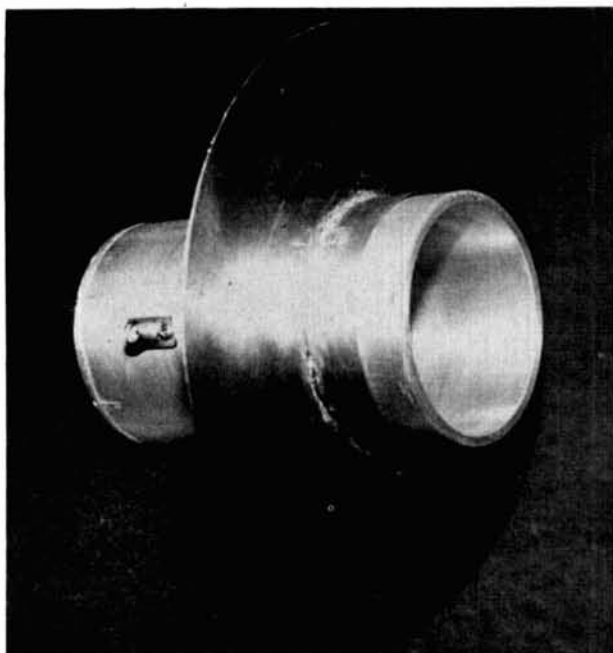

second-generation cylindrical feedhorns

Improved feedhorn provides
superior parabolic antenna
system performance

My original article describing cylindrical feedhorns¹ for use with parabolic reflectors appeared in *ham radio* in May, 1976. Judging from the number of inquiries that have been — and are still being — received, the subject is obviously pertinent to many Amateurs and experimenters interested in working in the UHF and SHF ranges. Variations of the design have been used on the 1296- and 2304-MHz Amateur bands as well as the MDS² and ITFS³ bands. The design is also well suited for use in the 3300-3500 MHz Amateur band.

I recently experimented with cylindrical feedhorns for reception of satellite TV signals in the 3.7-4.2 GHz band. The design requirements here are similar, but in my case much more stringent — not because the frequency is higher, but because I chose to use a very small-diameter dish reflector (8-foot, or 2.4 meters). Those who are familiar with TVRO design requirements know that 10-foot (3-meter) or larger re-

flectors are almost always specified. Therefore, everything in my system had to be exactly right to produce acceptable satellite TV pictures using the 8-foot (2.4-meter) dish. This meant that I had to pay particular attention to details.

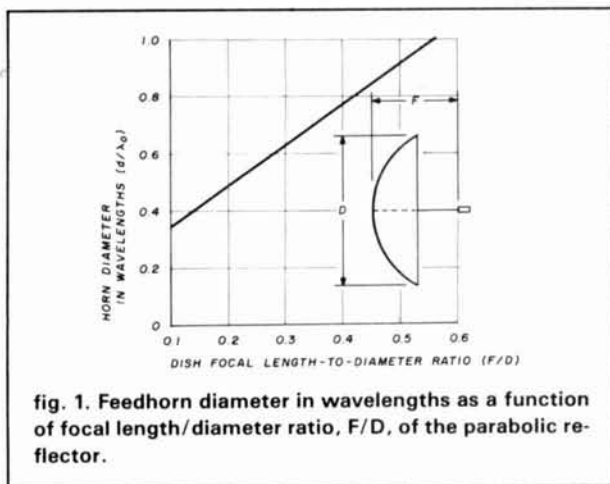

fig. 1. Feedhorn diameter in wavelengths as a function of focal length/diameter ratio, F/D , of the parabolic reflector.

By Norman J. Foot, WA9HUV, 293 East Madison Avenue, Elmhurst, Illinois 60126

While this activity is not normally considered Amateur Radio in the usual sense, the modifications I had to make to the original design are certainly applicable to the UHF and microwave Amateur bands. The purpose of this article is to describe the changes and the associated improvements in performance that were achieved. This information should be helpful to Amateur experimenters and others working with parabolic reflectors who are interested in obtaining superior performance from their antenna systems.

a review of feed-horn parameters

Important feedhorn parameters are length, diameter, and probe location. The most important of these is the inside diameter of the horn, which is tailored to match the associated reflector. The probe location is calculated after the diameter is established.

The original article specifies a minimum diameter of about 5.68 inches (14.4 cm) for the 1215-1300 MHz application to operate above the cutoff frequency of the circular guide. A horn this small has a very broad beam and so would normally be used with a very deep dish. Large-diameter horns produce narrow patterns and higher gains. Generally the diameter is selected to match the F/D ratio of the associated parabolic reflector to achieve optimum design. A match is achieved when the gain of the horn off boresight at the periphery of the dish is approximately 10 to 15 dB below the gain on boresight. This point is illustrated in fig. 3 of the original article. Note that my 3.7-4.2 GHz horn has a diameter of 2.25 inches (5.7 cm), which provides a good match to my 0.387 F/D ratio 8-foot (2.4-meter) reflector.

Fig. 5 of the original article was difficult to read because the graph contained no grid. This important graph has therefore been reproduced here in fig. 1, but in a more universal form. Instead of specifying diameters for a specific frequency, diameter is specified in terms of wavelength, d/λ_0 . This makes the graph useful at any frequency. For example, from fig. 1 the diameter of a horn used with a dish having an F/D ratio of 0.387 is $0.75\lambda_0$. Therefore, the 1296-MHz feedhorn should have a diameter of 6.83 inches (17 cm):

$$d = 0.75\lambda_0$$

$$\lambda_0 = 9.113 \text{ inches (23 cm)}$$

$$\text{Therefore, } d = 0.75 \times 9.113 = 6.83 \text{ inches (17 cm)}$$

The relatively critical probe location can be determined once the horn diameter is established. The original article describes the probe as being located a

quarter *guide* wavelength from the shorted end of the horn. The probe length is slightly shorter than a quarter *free-space* wavelength because of end capacitance. Reference should be made to the original article, which fully describes probe parameters and the tune-up procedure.

problem areas

Up to this point it has been assumed that the beam cross-section is circular and therefore that the reflector would be equally illuminated all around its circumference. Fortunately this is a very good assumption for cylindrical horns, especially those having large d/λ_0 ratios. In contrast, rectangular waveguide horns, which do not produce circular beams, require that a flare be added in the electric plane to achieve uniform illumination* in both the electric and magnetic planes.

Large-diameter cylindrical horns, such as might be used with shallow reflectors, generally exhibit side lobes as high as 8 to 10 dB below the peak of the main beam. This is not efficient and is particularly undesirable in TVRO systems.

Besides beam cross-section ellipticity and side lobes, there is a third effect relating to the abrupt discontinuity where the wave is launched from the open

*The reference here to illumination of the dish denotes use as a transmitting system. Based on the reciprocity theorem, the system will work equally well for receiving purposes, but it is probably easier to visualize in the transmitting mode.

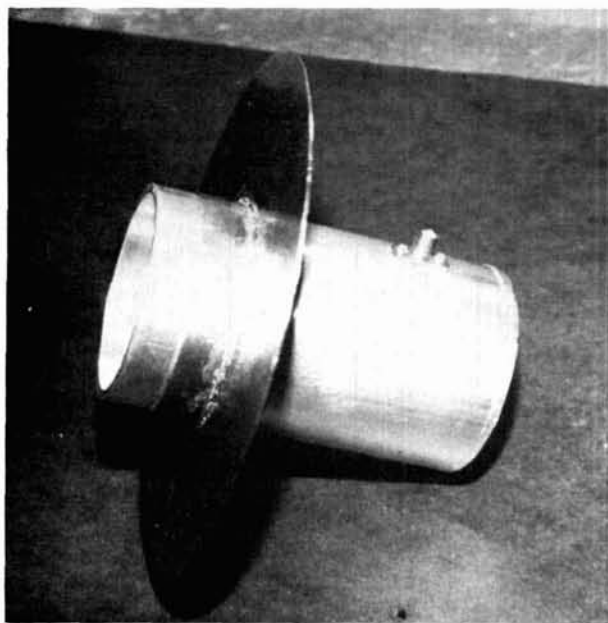

Second-generation feedhorn has space-age look. This 2¼-inch (15.7-cm) OD horn operates across the 3.7-4.2-GHz satellite TV band. Rf-choke disc increases gain by 2 dB and significantly improves overall system performance.

end of the horn. The discontinuity causes what is sometimes referred to as a back radiation.⁴ The amount of back radiation is large for small-diameter horns but approaches zero for diameters larger than one wavelength. In the present application, horn diameters greater than a wavelength would be used with only very shallow (large F/D) dishes.

The cylindrical feedhorn is in reality a short section of circular waveguide with its open end coupled into space. Since the impedance of circular guides is always greater than the 377 ohms of free space,⁵ a small amount of energy will be available for back

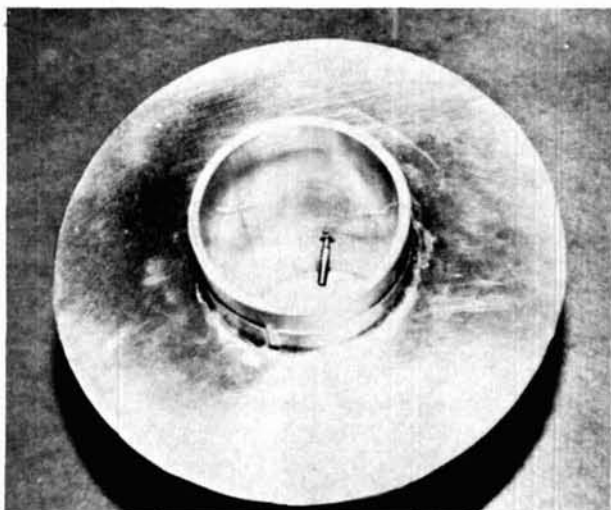

Another view of the horn showing probe location, which is calculated after horn diameter is established. The most critical horn parameter is inside diameter, which is designed to match the associated reflector.

radiation, while some energy may be reflected back into the coaxial input circuit. A means therefore is needed to reduce the discontinuity at the mouth of the horn; this should reduce VSWR and increase gain and efficiency.

matching the feed horn to free space

Experiments have shown that the addition of an rf choke on the outside of the feedhorn near the opening is very effective in reducing back radiation and providing a better impedance match. Measurements show that the resulting increase in gain of the main lobe is between 1 and 3 dB, depending on the ratio of d/λ_0 . VSWR measurements show that best impedance match is obtained when the choke is located at the best gain position.

The choke is a flat washer positioned coaxially on the horn and located behind the open end. The choke used for the 4-GHz horn was 6 inches (15.25



The flat disc rf choke is very effective in reducing back radiation and providing a better impedance match. VSWR measurements show that the best impedance match occurs when the choke is located at the best gain position. Details for adjusting the choke are given in the text.

cm) in diameter and it was positioned approximately 1-1/4 inches (3.175 cm) behind the opening. Note that the distance from the open end of the horn along the metal surface to the periphery of the choke is approximately one wavelength. Since this distance is critical, provisions are made for adjusting the position of the choke for tuning purposes. The effectiveness of the choke becomes clearly evident as it is moved back and forth during gain tests. Also, pattern tests show that the choke is effective in reducing minor lobes to very low levels and circularizing the

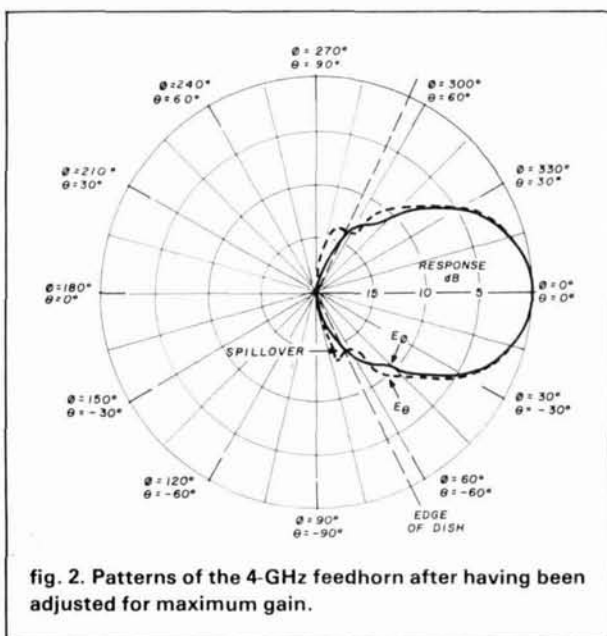

fig. 2. Patterns of the 4-GHz feedhorn after having been adjusted for maximum gain.

beam cross section. Thus, the choke is instrumental in improving *all* of the potential problem areas. Fig. 2 shows the patterns of the 4-GHz horn in both the electric and magnetic planes after the choke had been adjusted for maximum gain.

Fig. 3 illustrates the mechanical details of the 3.7-4.2 GHz horn, including the choke. Note that all of these dimensions can be scaled to other frequencies in proportion to wavelength except for probe location. The latter is a function of guide diameter, which in turn depends on F/D ratio of the reflector. Fig. 4 is a graph showing the probe location in terms of d/λ_0 .

design example

The amount of Amateur activity on 1296 MHz has been increasing rapidly during the past few years. Seven-foot (2-meter) diameter dishes are quite popular on this band because commercial units intended for UHF TV are easily modified for use at 1296 by the addition of screening and a more suitable feedhorn. It is appropriate, therefore, to include with this article a 1296-MHz design example of an improved feedhorn for this application.

Most 7-foot (2-meter) reflectors have an F/D ratio of approximately 0.38. From fig. 5 of the original article, the horn diameter is 6.75 inches (17 cm). The length is 12-14 inches (30-36 cm), but this dimension is not critical. Free-space wavelength is calculated as follows:

$$\lambda_0 = c/f_0$$

$$\lambda_0 = \frac{3 \times 10^{10}}{1.296 \times 10^9 \times 2.54} = 9.11 \text{ inches (23 cm)}$$

where $\lambda_0 = \text{free-space wavelength (inches)}$

$$c = 3 \times 10^{10} \text{ (cm/sec)}$$

$$f_0 = 1.296 \times 10^9 \text{ (Hz)}$$

Guide cutoff wavelength is calculated as follows:

$$\lambda_c = 3.42r$$

where $\lambda_c = \text{cutoff wavelength}$

$$r = \text{horn radius}$$

$$\lambda_c = 3.42 \frac{6.8}{2} = 11.63 \text{ inches (29.5 cm)}$$

The cutoff frequency, f_c , is 1016 MHz.

Finally, guide wavelength, λ_g , is:

$$\lambda_g = \frac{9.11}{\sqrt{1 - \left[\frac{9.11}{11.97} \right]^2}}$$

$$= 14.057 \text{ inches (35.7 cm)}$$

In other words, the probe should be 3.5 inches (8.9 cm) from the shorted end of the horn. The probe is slightly shorter than $\lambda_0/4$, or about 2-17/64 inches (5.75 cm). Its length should be adjustable over a dis-

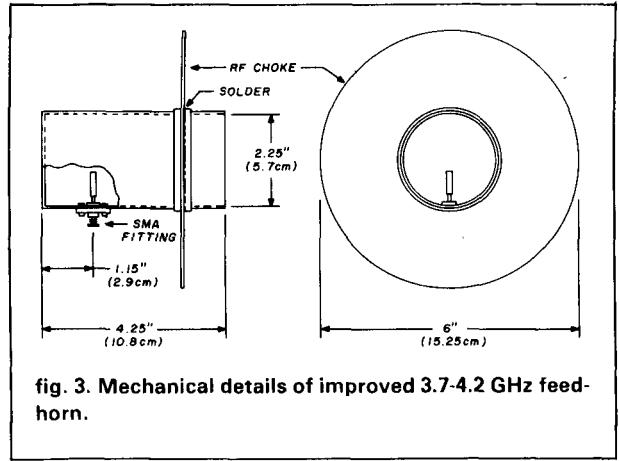

fig. 3. Mechanical details of improved 3.7-4.2 GHz feed-horn.

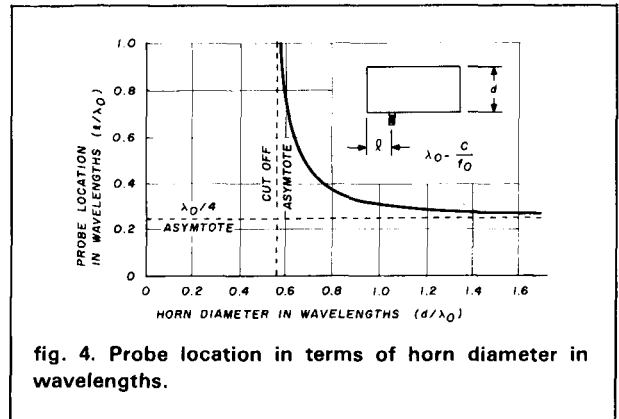

fig. 4. Probe location in terms of horn diameter in wavelengths.

tance of about $\pm 1/4$ inch (6mm). The adjustment for minimum VSWR should be made with the choke located at the maximum gain position. The technique illustrated in fig. 6 of the original article can be used for probe adjustment.

The 1296-MHz feedhorn should be equipped with an 18.5-inch (47-cm) diameter, 0.032-inch (0.8-mm) thick brass rf choke, located approximately 2-1/2 inches (6.35 cm) behind the open end of the horn. The inside diameter of the choke should be greater than the outside diameter of the horn, so that a 1-inch-wide, 0.032-inch-thick strip of brass can be soldered to the inside of the choke. This strip acts as a guide for adjusting the position of the choke, as illustrated in fig. 3. It also provides good electrical contact with the outer surface of the horn. Be sure the sliding surface is clean and free of paint and other insulating materials. Once the choke has been positioned for maximum gain, the outside surface of the horn and the choke can be sprayed with paint to protect these surfaces from the weather.

A typical 2304-MHz design uses a 4-inch (10-cm) diameter coffee can 5 1/2 inches (14 cm) long with a 10-1/2 inch (26.7-cm) diameter choke. The choke is

1-1/4 inches (3 cm) from the open end of the horn. The probe (monopole) is located 2-3/8 inches (6 cm) from the shorted end of the horn. The improvement in gain due to the choke for this horn was 2.0 dB. VSWR was measured at less than 1.1 between 2.0 and 2.5 GHz.

The choke can also be made from 0.032-inch (0.8-mm) aluminum sheet stock. Cut the inside diameter 1-1/2 inches (4 cm) smaller than the OD of the horn. Serrate the hole with a saber saw or hacksaw blade to the horn diameter, then bend the tabs at right angles to match the contour of the horn. Cuts should be made every 20 degrees or so. Finally place a hose clamp over the tabs to provide both a good electrical and mechanical contact with the horn.*

adjusting the choke

A suggested test setup for adjusting the position of the rf choke for maximum feedhorn gain is shown in fig. 5. A signal generator or other rf power source drives a dipole illuminating antenna. The dipole should have a reflector as shown, and a balun might also be used to connect the unbalanced generator to the balanced dipole antenna terminals.

The horn antenna under test should be located at a distance from, and looking directly at, the illuminating antenna. A separation distance of 8 or 10 feet (2 or 3 meters) is generally satisfactory, although closer spacing may be necessary at higher frequencies. Orient the antennas so their polarizations match. Connect the output of the feedhorn to the input of a sensitive rf detector driving a microammeter or dc VTVM. If an rf amplifier is available, it can be inserted between the horn and rf detector to obtain greater measurement sensitivity. Another option is to connect the output of the feedhorn to the input of a

converter and receiver combination; the receiver's S-meter can serve as the detector. In none of these situations is the radiation pattern of the transmitting antenna particularly critical, except that reasonable directivity is necessary to avoid reflections from nearby objects if the test is run indoors.

After having obtained a preliminary detector reading, slide the choke back and forth to identify the point that provides maximum detector current. Gain should be approximately 1.5 to 2.5 dB greater with the choke than without it. You can check this by removing the choke and noting the increase in generator output power necessary to recover the lost gain.

closing remarks

We Amateurs have known as far back as we can remember that the most simple and least expensive way to improve system performance is by increasing antenna gain. Because this is equally true for receiving and transmitting, any successful effort to improve the antenna is felt at both ends of the contact.

As we move from VHF to UHF in our quest for new experiences, we find that the parabolic antenna system is used more and more. While there are very few dishes in use at 432 MHz and below — other than at a few EME installations — fifty-three percent of all stations listed in the 1981 1296-MHz directory⁷ who specified their antenna type are using parabolic reflectors. These range in size from 30 inches (0.75 meter) to 25 feet (7.6 meters) in diameter. The move to 2304 MHz will very likely see even greater use of the dish.

In my case, the need to stretch antenna performance to the limit in an effort to achieve "sparklie-free" TV images with the use of a very small parabolic reflector provided the impetus for improvement. It seems to me that Amateur EME and long-haul over the horizon (forward scatter) circuits stand to benefit also. I shall be delighted to hear from Amateurs and experimenters who prove this to be a correct hypothesis.

*Templates for several horn sizes are available from the author. Please state horn diameter and enclose \$2.00 to cover the cost of printing and mailing.

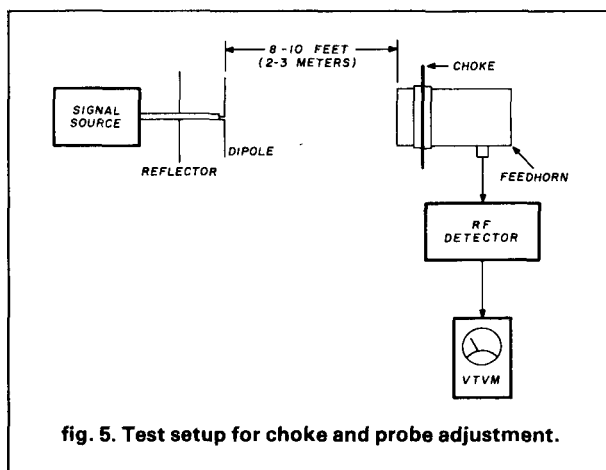

fig. 5. Test setup for choke and probe adjustment.

references

1. Norman Foot, WA9HUV, "Cylindrical Feed Horns For Parabolic Reflectors," *ham radio*, May, 1976.
2. James Edwards, "MDS: What Is It?" 73, November, 1978.
3. H. Paul Shuch, "A Vidiot's Guide to Microwave TV," Micro-Comm, 14908 Sandy Lane, San Jose, California 95142.
4. *Very High Frequency Techniques*, Vol. 1, McGraw-Hill, 1947, Radio Research Laboratory Staff, pages 138-140.
5. G. Southworth, *Principles and Applications of Waveguide Transmission*, D. Van Nostrand Company, Inc., New York, 1950.
6. John D. Ryder, *Networks, Lines, and Fields*, Prentice-Hall, Inc., 1949, pages 424-425.
7. Central States VHF Society, *1981 1296 MHz Directory*, WB5LUA, Rt. 7, Box 32, McKinney, Texas 75069.

Barry Electronics Corp.

WE SHIP WORLDWIDE

WORLD WIDE AMATEUR RADIO SINCE 1950

Your one source for all Radio Equipment!

All Handy Talkies In Stock For Immediate Delivery!

VoCom 2 meter 5/8 Telescoping Whip & Duckie

"Kitty Says" Antennas & HT Amp's HEAVILY STOCKED

We Will Not Be Undersold Call: 212-925-7000

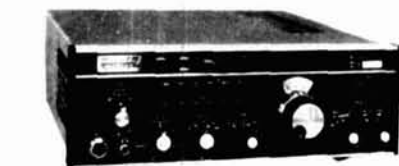

DRAKE TR-5, TR-7, R-7, L-7, L-15, & Theta-7000E



TEN-TEC Omni "C"

YAESU FT-ONE



FT-101ZD MARK III, FT-480R, FT-707, FT-720RU, FT-720RVH, FT-902DM, YR-901-CW/RTTY



ROCKWELL/COLLINS KWM-380



ROBOT 400 & 800

SANTEC HT-1200, ST-7/T ST-144/UP



TEMPO S1, S2, S4, S5



YAESU FT-208R FT-708R

ICOM IC2AT IC3AT IC4AT



DIGITAL FREQUENCY COUNTER

Trionyx-Model TR-1000 0-600 MHz
Digimax-Model D-510 50Hz-1GHz



FM-2025



MIRAGE B-23, D-1010, B-1016



ICOM IC-720A, IC-730 IC-25A, IC-251A, IC-2KL, IC-451A

HY-GAIN TOWERS & ANTENNAS

KANTRONICS Mini-Reader Field Day

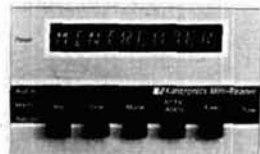

MURCH Model UT2000B



AEA Morse Matic, MBA & IsoPole Antennas



BIRD Wattmeters & Elements in stock



ASTRO 103 150A & 100 MXA DIPLOMAT 150

SPECIAL! FTZ-720 RU Mobile Transceiver 440-450 MHz (also available 430-440 MHz) \$299.00. FTZ-720 RVH 144-148 MHz Super Special \$299.00. WHILE THEY LAST!

New York City's

LARGEST STOCKING HAM DEALER
COMPLETE REPAIR LAB ON PREMISES

WE STOCK ARRL & BASH PUBLICATIONS.

MAIL ALL ORDERS TO BARRY ELECTRONICS CORP., 512 BROADWAY, NEW YORK CITY, NEW YORK 10012. BARRY INTERNATIONAL TELEX 12-7670 212-925-7000 TOP TRADES GIVEN ON YOUR USED EQUIPMENT.

AUTHORIZED DIST. MCKAY DYMEK FOR SHORTWAVE ANTENNAS & RECEIVERS.

"Aqui Se Habla Espanol!"

WE STOCK: KLM ANTENNAS, UHF & VHF AMPLIFIERS, NEW ROBOT MODEL #800, BIRD WATTMETER, HY-GAIN, LARSEN, SHURE, KDK-2015R, TURNER, ASTATIC, VOCOM, VHF ENG., MFJ, KANTRONICS, AVANTI, CORDLESS TELEPHONES, POCKET SCANNERS, NYE, BENCHER, VIBROPLEX, ALPHA.

WE NOW STOCK COMMERCIAL COMMUNICATIONS SYSTEMS DEALER INQUIRIES INVITED. PHONE IN YOUR ORDER & BE REIMBURSED.

Amateur Radio Courses Given On Our Premises
Export Orders Shipped Immediately.

A grounded, vertically polarized antenna with some interesting features

the half-delta loop

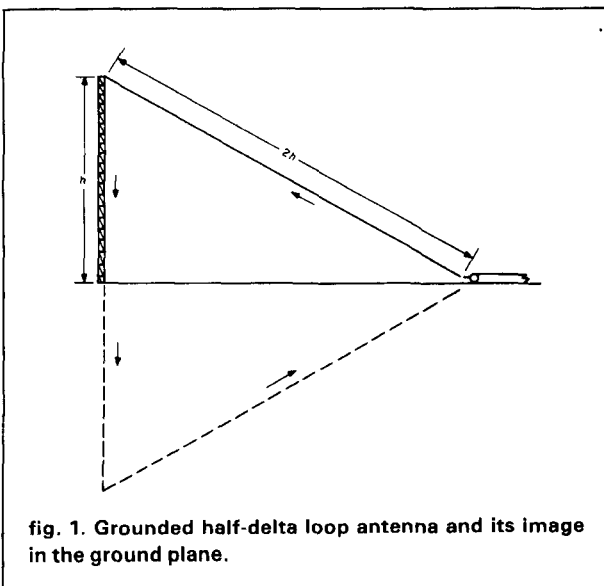

In a recent article on the half-sloper antenna,¹ I suggested that a half-delta loop configuration would make a better antenna system. That is, the sloping wire would be attached to the top of a grounded tower, and this wire would be end fed, against ground at its far end (see fig. 1). The length of the half-delta loop, including tower height plus length of the sloping wire would be an electrical half wavelength, but the loop is "full-wave resonant," if account is taken of its image in the ground plane. Obviously, characteristic of monopole grounded anten-

By John S. Belrose, VE2CV, 3 Tadoussac Drive, Aymer (Lucerne), Quebec J9J 1G1, Canada

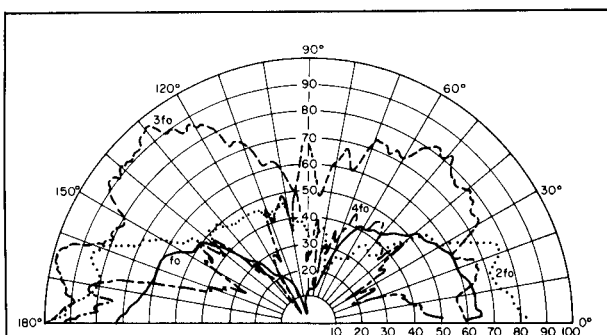

fig. 2. Vertical radiation pattern, vertical polarization, measured in the plane containing the half-delta loop, for the lowest resonant frequency (f_0) and for various harmonic frequencies ($2f_0$, $3f_0$, and $4f_0$).

nas, the half-delta loop will work best if a ground screen is used to improve the image that it sees of itself in the ground plane, and to provide a low resistance for return current flow in the ground to the grounded side of the coaxial feed. At the very least, a wire buried in the ground should connect the base of the tower to the shield of the coaxial feed cable, and two six-foot (2-meter) ground rods should ground the tower and the ground side of the feed.

design considerations

While other configurations will work, the antenna discussed here was arranged as a delta loop; that is, the antenna and its image have the shape of an equilateral triangle. Thus if the tower height is h , the length of wire should be $2h$, and therefore:

$$3h = k\lambda/2$$

$$h = \frac{k\lambda}{6}$$

where k is a factor greater than 1 that relates the physical and electrical lengths of the antenna. For the model antenna built for test and evaluation at a scale frequency of 200 MHz, k was experimentally determined to be about 1.12.

Thus the table below gives approximate dimensions for half-delta loop antennas for 160, 80, and 40 meters.

f	tower height, h,		length of sloping wire,		band
(MHz)	feet	(meters)	feet	(meters)	(meters)
1.8	100	(30.5)	206	(62.8)	160/80/40
3.6	50	(15.3)	103	(31.4)	80/40/30/20
7.15	25	(7.6)	52	(15.8)	40/20/15/10

Unlike dipoles, which are resonant at f_0 , $3f_0$, $5f_0$, etc., the half-delta loop is resonant at all harmonics of its fundamental frequency f_0 , $2f_0$, $3f_0$, $4f_0$, etc.

Measured radiation patterns for the modeled antenna, measured on the National Research Council, Ottawa, antenna pattern range,¹ are given in figs. 2 and 3. The curves in fig. 2 show the vertical radiation pattern for vertical polarization, measured in the plane containing the antenna, at the lowest resonant frequency of the antenna, f_0 , and for various harmonics of this frequency ($2f_0$, $3f_0$, and $4f_0$). While the polar pattern becomes more complicated at the higher harmonics, the antenna radiates essentially like a monopole antenna in that the polarization is vertical, and maximum gain is directed toward the horizon.

The curves in fig. 3 show the azimuthal radiation patterns for vertical polarization for a launch angle of 10 degrees above the horizon, measured at these same frequencies. The polar pattern at the fundamental frequency is interesting; the antenna radiates in the plane broadside to it like two quarter-wave monopoles in phase. In this figure, the tower was located at the center of the polar diagram, and the delta loop had its apex directed toward the 0 coordinate. At harmonic frequencies the antenna exhibits a different directivity. The maximum gain occurs in the plane containing the antenna, rather than broadside to this plane, with the greatest gain in the direction away from the tower and its feed; and nulls appear in the plane broadside to the antenna — the nulls at $3f_0$ are particularly deep.

The vertical radiation patterns for horizontal polarization in the plane broadside to the half-delta loop

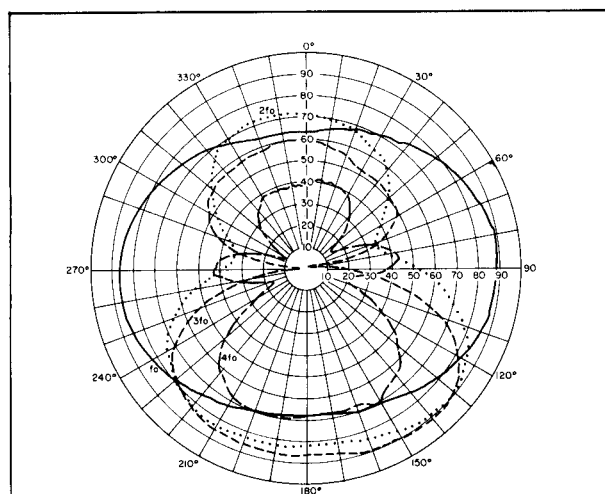

fig. 3. Azimuthal radiation pattern, vertical polarization, measured at an angle above the horizon of 10 degrees for the half-delta loop at its lowest resonant frequency (f_0) and for various harmonic frequencies ($2f_0$, $3f_0$, and $4f_0$). The delta loop was located at the center of the polar plot with its apex directed toward the 0-degree coordinate.

were also measured, and although these patterns are not shown, the horizontal field was small (especially at f_0 and $2f_0$). That is, the antenna radiates dominantly like a vertically polarized antenna.

The input impedance of the antenna, mounted on an aluminum sheet, was about 74 ohms at f_0 , and the SWR was less than 2:1 at the second and third current mode resonances, which occurred at frequencies of 1.7 and $2.71 f_0$ (that is, about 10 percent lower than exact multiples of the fundamental frequency).

influence of ground conductivity on the vertical pattern

While we have not calculated the pattern for antennas mounted on a finitely conducting earth, the effect is expected to be like that for a vertical monopole antenna. Fig. 4 shows, for reference, calculated patterns for a quarter wave monopole antenna above earth having poor and good conductivity, compared with sea water, for 4 and 14 MHz.² The gain (greater than 2.15 dBi) comes about by the fact that a grounded monopole radiates into a hemispherical space, whereas a dipole antenna in free space radiates in all directions (over spherical space).

In concluding this brief discussion on the effect of the finite conductivity of the ground on the vertical radiation pattern of a vertically polarized antenna, and on the need to provide a ground screen beneath a current-fed grounded antenna, let me comment on a moot point not well understood. A radial ground screen beneath the antenna provides a low resistance path for the return current flow to the base of the antenna, or to the ground side of the coaxial feed in the case of the half-delta loop antenna. This is necessary to reduce the effective ground loss resistance, so that the antenna current contributes to radiation and not to ground loss. The ratio of the radiation resistance to the ground loss resistance referred to the feed point must be high for good radiation efficiency. However, to launch sky waves at a low elevation angle (less than 10 degrees) above the horizon, the ground conductivity fifty or more wavelengths in front of the antenna is important. As shown in fig. 4 the effect of the conductivity of the earth is large, particularly at low angles, and the influence of the ground extends well beyond the limits of practical ground screens. This point was discussed in my subsequent article.³

The various patterns shown in figs. 2 and 3 are relative. While no attempt was made to measure the gain of the antenna at the harmonic frequencies, it should be noted that the pattern for the *fundamental frequency*, f_0 , was referenced to a half-wave dipole antenna one-quarter wavelength above the ground

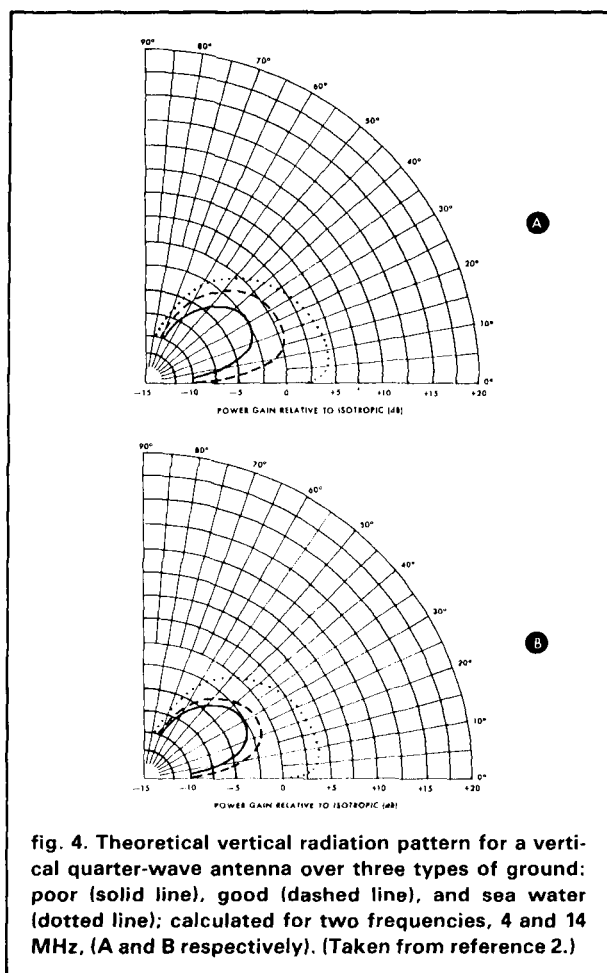

fig. 4. Theoretical vertical radiation pattern for a vertical quarter-wave antenna over three types of ground: poor (solid line), good (dashed line), and sea water (dotted line); calculated for two frequencies, 4 and 14 MHz. (A and B respectively). (Taken from reference 2.)

plane; and 45 on the relative-amplitude scale corresponds to approximately zero dBd. The antenna therefore exhibits a maximum gain approximately 6 dB over a dipole in free space.

acknowledgements

I wish to express my thanks to L.R. Bode of the Communications Research Centre, Department of Communications, Ottawa, who built the model antenna and measured its impedance, and to W. Lavrench (VE3LAV) and J.G. Dunn, who measured the antenna pattern on the National Research Council's (Ottawa) antenna pattern range.

references

1. John S. Belrose, "The Half Sloper -- Successful Deployment an Enigma," *QST*, May, 1980.
2. J.L. Thomas and E.D. DuCharme, "HF Antenna Handbook Calculated Radiation Patterns," Communications Research Centre Report No. 1255, Ottawa, April, 1974.
3. John S. Belrose, "The Half-Wave Vertical," *ham radio*, September, 1981.

ham radio

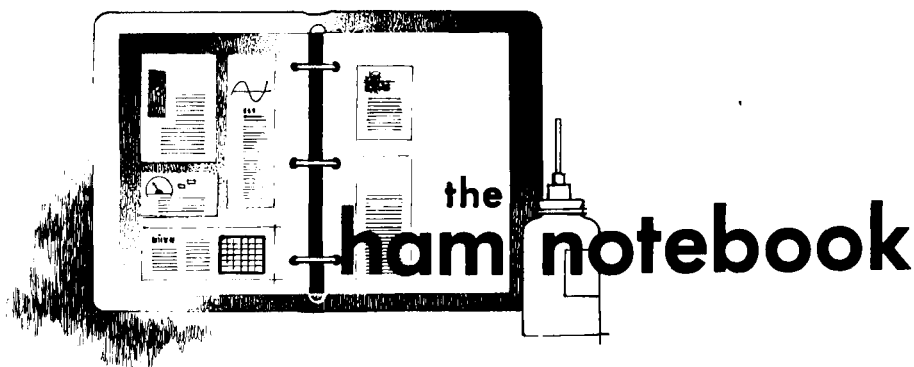

inexpensive automatic send/receive change-over relay

Many older tube transmitters using cathode keying can be retrofitted to provide inexpensive and automatic antenna send/receive change-over. All that's necessary is an antenna change-over relay controlled by the same circuit that grounds the final-amplifier tube cathode. However, unless one provides for a delayed release, the change-over relay "clunks" along with every depression of the key.

circuit

With the addition of a diode, a resistor, a large capacitor, and a sensitive relay (fig. 1), the initial depression of the key enables the antenna change-over relay as before, but the relay will not return to the receive position during subsequent code spaces until a short time delay has occurred. This time delay can be controlled by the sensitivity and dropout characteristics of the relay, and by the size of the capacitor. The delay can be made long enough to bridge spaces between characters, or even between words, with the proper choice of components.

operation

Assume that the key has been open for some time. The capacitor will have been charged to some positive voltage, there will be no potential difference across the sensitive relay to cause any current flow, and both

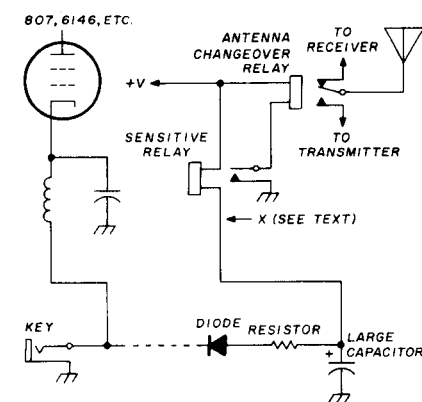

fig. 1. Inexpensive automatic send/receive change-over relay. Values for the diode, resistor and capacitor are discussed in the text.

relays will be de-energized (fig. 1). Closing the key will discharge the capacitor through the diode and the small series resistor (the resistor is included only to protect the diode by limiting the discharge current). This action will produce a potential difference across the sensitive relay, causing current to flow through it. Its closing then will activate the antenna change-over relay. If an additional contact on the antenna change-over relay controls the B+ to the transmitter final amplifier, this entire switching process will be completed by the time any rf power has been generated, and the normal load will be presented to the final amplifier.

When the key has been released, the diode will prevent leakage current through the tube from keeping the capacitor charged. (Note that the diode's PIV rating must be sufficient

to withstand the key-up voltage at the cathode.) Thus, the capacitor will begin to charge from the current flowing through the sensitive relay. However, this current will keep the sensitive relay energized until the voltage across the capacitor has increased to the point that the potential difference across the sensitive relay is less than its dropout voltage (a relay's dropout voltage is always less than its pull-in voltage). If the key recloses before dropout occurs, then the capacitor will again discharge, and the cycle will repeat when the key is released. If the key remains open long enough (as at the end of the message), both relays will de-energize and reception again will occur.

additional notes

Since no internal connections to the transmitter are required, this change-over scheme can also be implemented as an outboard accessory. The relay can include contacts for more than antenna and transmitter power switching. Additional contacts can ground the receiver's antenna input, turn off the receiver's B+, turn on the linear's power, or dim the lights. In many cases the change-over relay may require a higher positive voltage than the sensitive relay (+12 volts versus +6 volts, for example); a dropping resistor may be inserted at point X in fig. 1.

final comments

The version of this circuit that I've retrofitted into two war-surplus TCS-13 transmitters used a junkbox rectifier diode, a 27-ohm, 1/2-watt resistor, a 1000- μ F capacitor, and a small reed relay. The TCS-13 had two change-over relays. After the initial "ka-lunk," operation was blissfully quiet for about one second after the last key-down period, at which time a smaller clunk occurred, and the receiver was again operative.

Myron A. Calhoun, W0PBV

(Continued on page 42)

SAVE \$200



IC-720A Digital HF Transceiver. 160-10m, including 10, 18 & 24 MHz. 100w. 13.8Vdc/15A. 4 1/2" h x 9 1/2" w x 12 1/2" d. Wt. 17 lbs. (Regular \$1349) ... **NOW \$1149.00**
FL-32 500Hz CW filter 59.50
FL-34 5.2 KHz AM filter 49.50

SAVE \$129



IC-730 Digital HF Xcvr 80-10m, incl. 10, 18 & 24 MHz. 200w PEP. UP/DN tune w/optional HM-10 mic. 9 1/2" h x 3 3/4" w x 10 1/2" d, 10 lbs. (Reg. \$829) ... **NOW \$699.95**
FL-30 SSB filter (passband tuning) 59.50
FL-44 455 KHz SSB filter (Reg. \$159) ... **NOW 144.95**
FL-45 500 Hz CW filter 59.50
EX-195 Marker unit 39.00
EX-202 LDA interface; 730/2KL/AH-1 27.50
EX-203 150 Hz CW audio filter 39.00
EX-205 Transverter switching unit 29.00
HM-10 Scanning mobile microphone 39.50

Accessories for 720A & 730
PS-15 Power supply (Reg. \$149) **NOW \$134.95**
PS-20 20A power supply (Reg. \$229) ... **NOW 199.95**
 Adaptor cable for PS-20 to 720A or 730 10.00
CF-1 Cooling fan for PS-15* or PS-20 45.00
EX-144* Adaptor for CF-1 to PS-15 6.50
MB-5 Mobile mount 19.50
 Phone patch - specify radio (Reg. \$139) **NOW 129.95**
SP-3 Base station speaker 49.50
SM-5 Electret desk microphone 39.00
AH1 Mobile ant. & tuner (Reg. \$289) ... **NOW 259.95**
AT-100 100w auto. tuner (Reg. \$349) ... **NOW 314.95**
AT-500 500w auto. tuner (Reg. \$449) ... **NOW 399.95**

SAVE \$400



IC-2KL HF linear. 160-15m, including 10 & 18 MHz. Solid-state broadband tuning. 500w out. Automatic with 720A & 730 w/EX-202 (Reg. \$1795) .. **NOW \$1395.00**



SAVE \$\$ - VHF/UHF



IC-251A 2m All-mode Xcvr. 144.8-148.1999 MHz. 10w, digital, memories, scan, 2 VFOs 13.8Vdc/117vac. 4 1/2" h x 9 1/2" w x 10 1/2" d, 11 lbs (Reg. \$749) **NOW \$599.95**

IC-451A UHF All Mode Transceiver for OSCAR mode B or J & simplex. Models for 430-440 or 440-450 MHz. Similar to IC-251A (Regular \$899) **NOW \$769.95**
IC-AG1 UHF Preamplifier (Reg. \$89) **NOW \$79.95**

IC-551 6m SSB/CW/(FM*) transceiver. 50-53.999 MHz. 10w, digital readout, memories, scan, two VFO's & noise blanker. 13.8Vdc/117vac (Reg. \$479) ... **NOW \$399.95**
EX-106* FM adaptor (Reg. \$125) **NOW 112.95**
EX-107 VOX unit (Reg. \$55) **NOW 49.95**
EX-108 PB tune/RF proc. (Reg. \$105) ... **NOW 94.95**

IC-551D same as 551 but 80w. **EX-107** & **EX-108** built-in. 13.8Vdc/18A - PS-20* (Reg. \$699) ... **NOW 599.95**
PS-20* AC power supply (Reg. \$229) ... **NOW 199.95**
CF-1 Cooling fan for PS-20 45.00

IC-560 6m SSB/CW/FM Mobile Xcvr. 10w, digital, three memories, mem. & band scan, two VFOs. 13.8Vdc/3.5A. 2 1/2" h x 7 1/4" w x 9" d, 6 lbs. (Reg. \$489) ... **NOW \$439.95**



IC-25A Compact 2m FM Mobile Xcvr. 25w, 5 memories, scan, priority ch., 2 VFOs, T/T microphone. 2" h x 5 1/2" w x 7" d, 3 1/2 lbs. (Regular \$349) ... **NOW \$309.95**



IC-290A 2m All mode mobile transceiver. 143.8-148.199 MHz, 1/10w, 5 memories, 2 VFOs, scan, T/T mic. Remote tuning w/opt. HM-10 mic. 6 1/2" w x 2 1/2" h x 8 1/2" d (Regular \$549) **Limited Special! \$439.95**

IC-490A 432 MHz All Mode mobile transceiver. 430-439.995 MHz, 10 watts, scanning microphone **TBA**

IC-22U 800 ch. mobile. 144-147.995 MHz, 1 or 10 watts, thumbwheel frequency selection. 6 1/2" w x 2 1/2" w x 8 1/2" d, 3 1/2 lbs. (Reg. \$299). **Limited Special! \$239.95**

EX-199 Remote frequency selector 35.00



SAVE \$30

IC-2AT Synthesized 2m FM Hand-held with T/T pad. 800 ch. in 5 KHz steps, 144-147.995, selected by thumb wheels & +5 KHz upshift switch; ± 600 KHz offsets. 15 or 1.5w output with supplied nicad pack. Optional packs for larger capacity or higher power. Supplied with 250 ma. nicad pack (BP-3), wall charger, flex antenna, belt clip, strap, earphone and plugs. 6.6" h x 2.6" w x 1.4" d, 1 lb.

Regular SPECIAL!
IC-2AT HT w/TTP, nicad & chgr \$269.50 **\$239.50**
IC-2A 2m HT w/nicad & wall chgr ... **\$239.50 214.50**
ML-1 2.3/10w 2m mobile linear 89.00 **79.95**
IC-3AT 220 HT/TTP, nicad & chgr 299.95 **269.95**
IC-3A 220 HT/nicad & charger 269.95 **244.95**
IC-4AT 440 HT/TTP, nicad & chgr 299.95 **269.95**
IC-4A 440 HT/nicad & charger 269.95 **244.95**

HT Accessories:
BC-25U Extra wall charger **Regular \$12.50**
BC-30 Drop-in charger for BP-2, 3 & 5 69.00
BP-2* 450 ma, 7.2v nicad pk, 1w output 39.50
BP-3 Extra 250 ma nicad pk, 1.5w output 29.50
BP-4 Alkaline battery case 12.50
BP-5* 450 ma, 10.8v nicad pk, 2.3w output 49.50
 *BC-30 required to charge BP-2 & BP-5
CP-1 Cig lighter plug & cord (BP-3) 9.50
DC-1 DC operation module 17.50
HM-9 Speaker/microphone 34.50
Leather case (specify radio) 34.95
FA-2 Flexible antenna for 2A, 2AT (BNC) 10.00
3A-TTN TT pad for 2A, 3A, 4A 39.50
Commspec SS-32M 32-tone encoder 29.95

VHF/UHF Portables:
IC-202S 2m SSB Transceiver. 3w PEP output. Uses "C" cells; optional Nicad pack/charger or AC supply/spkr. With mic., ant. & strap (Regular \$279) ... **NOW \$249.95**
IC-20L 2m, 10w ampl. (Reg. \$98) ... **NOW 89.95**
IC-402 432 Mhz portable SSB Transceiver. Features same as IC-202S above (Reg. \$389) **NOW \$349.95**
IC-30L 10w, 432 amp. (Reg. \$105) ... **NOW 94.95**
IC-502A 6m SSB port. (Reg. \$239) **NOW 214.95**
IC-3PS ps/spkr; portables (Reg. \$95) **NOW 89.95**
BC-15 Nicads & AC chgr for portables 57.50
BC-20 Nicads & DC-DC chgr for portables 57.50
SP4 Remote speaker for portables 24.95

Accessories:
BU-1 Memory back-up; 25A/290A/490A **\$38.75**
BC-10A Memory back-up; 551D/720A/730 9.50
EX-2 Relay box w/marker; 720A/730/701 34.00
IC-3PE 3A ps/speaker (Regular \$95) **NOW 89.95**
HM-10 Scanning mic.; 25A/255A/290A/730 39.00
SM-2 4-pin electret desk microphone; 551/D 39.00
SM-5 8-pin electret desk mic.; 251A/451A 39.00

HOURS: Mon, Tue, Wed & Fri 9-5:30; Thurs* 9-8; Sat 9-3
 *Las Vegas & Florida stores NOT open Thursday evenings

E-X-P-A-N-D-E-D WATS PHONE HOURS
 Our Milwaukee Headquarters will answer the Nationwide WATS line 1-800-558-0411 until 8 pm (Milwaukee time) Monday thru Thursday.

Please use WATS line for Placing Orders
 For other information, etc. please use Regular line

Call Toll Free: 1-800-558-0411

In Wisconsin (outside Milwaukee Metro Area)
 1-800-242-5195

AMATEUR ELECTRONIC SUPPLY[®] Inc.

4828 W. Fond du Lac Avenue; Milwaukee, WI 53216 - Phone (414) 442-4200

AES BRANCH STORES

Associate Store

WICKLIFFE, Ohio 44092
 28940 Euclid Avenue
 Phone (216) 585-7388
 Ohio WATS 1-800-362-0290
 Outside Ohio 1-800-321-3594

ORLANDO, Fla. 32803
 621 Commonwealth Ave.
 Phone (305) 894-3238
 Fla. WATS 1-800-432-9424
 Outside Fla. 1-800-327-1917

CLEARWATER, Fla. 33515
 1898 Drew Street
 Phone (813) 461-4267
 No In-State WATS
 No Nationwide WATS

LAS VEGAS, Nev. 89106
 1072 N. Rancho Drive
 Phone (702) 647-3114
 No In-State WATS
 Outside Nev. 1-800-634-6227

CHICAGO, Illinois 60630
 ERICKSON COMMUNICATIONS
 5456 N. Milwaukee Avenue
 Phone (312) 631-5181
 Outside ILL. 1-800-621-5802

modifications to the Atlas 350 AGC circuit

A renewed interest in CW and comments by Doug McDougall (*ham radio*, January, 1980, page 88) led to the following modification of an Atlas 350. The AGC characteristics remained unchanged whether operating CW or SSB. On CW, a shorter delay is desired, especially when operating QSK.

The original circuit used a 1-meg resistor as the discharge path for the AGC capacitor, C313. I decided that two resistors in series, one of which could be shorted out during CW, would allow two AGC time constants. The circuit (fig. 2) was developed and built onto a small piece of PC material, which was soldered to the ground plane of PC320, the AGC/AUDIO board. R1 and R2 replace R316, the 1-meg AGC resistor. R1 determines the CW response, while R2 was chosen to retain the original SSB response.

The TUNE/CW-SSB switch provides ground and a voltage to operate the circuit. On SSB a ground is pro-

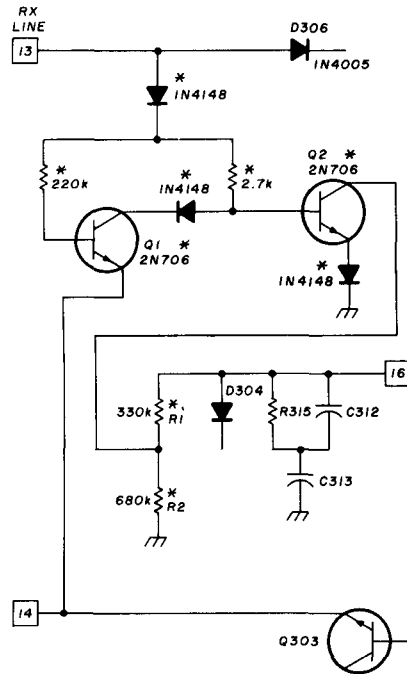

fig. 2. Modifications to the Atlas 350 AGC circuit for a shorter delay when in CW mode. Parts marked with an asterisk are added.

vided to Q1, which turns on, thereby turning Q2 off; R2 is now in the circuit. When in TUNE/CW, Q1 has a

voltage applied to its emitter and therefore conducts less, allowing Q2 to turn on, placing its now small collector-emitter resistance in parallel with R2, which makes R1 the primary discharge resistance.

Performance is good, and I've noticed no degradation of operation.

Ron Lile, KØRL

tailoring audio response

This is an old idea with merit, but I've not seen it in print for some time. Listening to the receiver hiss during long periods of reception can be tiring. The audio response of a low-impedance speaker or phones may be tailored by adding an electrolytic capacitor of about 50 μ F across the receiver speaker terminals or audio output jack. This cap will limit the audio high-frequency response and thus the hiss, making both CW and SSB reception more pleasant. Some overall attenuation will occur but it is relatively minor and can be compensated for by increasing the audio gain.

Paul K. Pagel, N1FB

antiflex coaxial cable connection

High onshore winds at my shack caused failure of my coax cable, the result of flexing where it emerged

from the lower end of my antenna balun. I solved the problem by distributing the torque over a length of

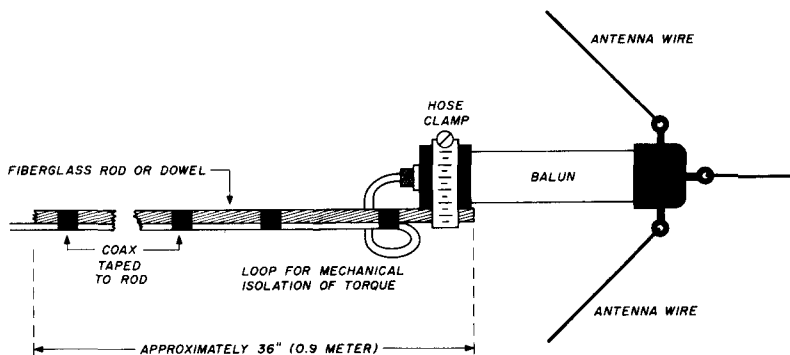

fig. 3. Method of securing coax cable to avoid failure from flexing.

cable as shown in fig. 3. I used a length of fiberglass rod tip salvaged from a discarded fishing pole, which I attached to the balun with a 1.75-inch (4.4-cm) stainless-steel hose clamp. The cable was then taped to the rod as shown in the sketch. The tape was further secured by wrapping small-diameter nylon (not monofilament) line over the tape using a clove hitch. The line prevents the tape from loosening when the adhesive dries out. Finally, I covered the tape and twine with a generous coat of coil dope.

While flexibility of the rod is important, a 1/4-inch (6-mm) length of maple dowel should do the job nicely if it's tapered down to about 3/16 inch (4.8 mm) at the lower end.

Lefferts A. McClelland, W4KV

Introducing the Universal Communication's DL-2000 Satellite TV Receiver

The LATEST in state-of-the-art TVRO Equipment

FEATURES:

- Built in modulator
- Built in Scan to aid in satellite tracking
- Built in metering
- True Wide-band threshold extension
- Video polarity shift
- Variable sound tuning
- Active clamping circuit, true clamp not diode
- Switchable LNA power down coax
- Atmospheric tested down to -50°F
- Local oscillator leakage minimized by special mixer design
- Add-on remote control only \$38.50 extra

Accessories

LNAs: \$595 and up
Power Supplies
Feedhorns and Antennas

Price \$749.95 each
\$699.95 in lots of 10 or more

**UNIVERSAL
COMMUNICATIONS**

P.O. Box 339
Arlington, TX 76004-0339

OUR PRODUCT MAY BE COPIED,
BUT THE PERFORMANCE IS NEVER EQUALLED.

(817) 860-1641





a Fresnel-zone plate for 10.4 GHz

An alternative to
a parabolic reflector for
your Gunnplexer transceiver

An increasing number of Radio Amateurs are stepping up to the 10.4-GHz Amateur band (10.0-10.5 GHz) to experiment with centimeter wavelengths and Gunn diode oscillators. The popular Gunnplexer transceivers offer the Amateur an excellent introduction to the 10.4-GHz band with a minimum of effort. (A recommended text is *The Gunnplexer Cookbook*, by Bob Richardson, W4UCH. It's available from Ham Radio's Bookstore, Greenville, New Hampshire 03048 for \$9.95 plus \$1.00 shipping.)

The Gunnplexer uses a Gunn diode and a low-noise Schottky diode in a cavity that operates in the homodyne mode. The Gunn diode oscillates at the desired microwave frequency, which is the transmitted carrier frequency. The received carrier frequency is at some offset frequency (could also be the transmitted frequency that is returning to the Gunnplexer with some Doppler shift), which is mixed in a Schottky diode with the transmitted carrier frequency. The resulting i-f is then fed to a conventional high-frequency or VHF receiver for demodulation.

The common method of improving the performance of the Gunnplexer is the addition of a horn or

By **William M. Brooks, WB6YVK**, 2050
Southwest Expressway 66, San Jose, California
95126

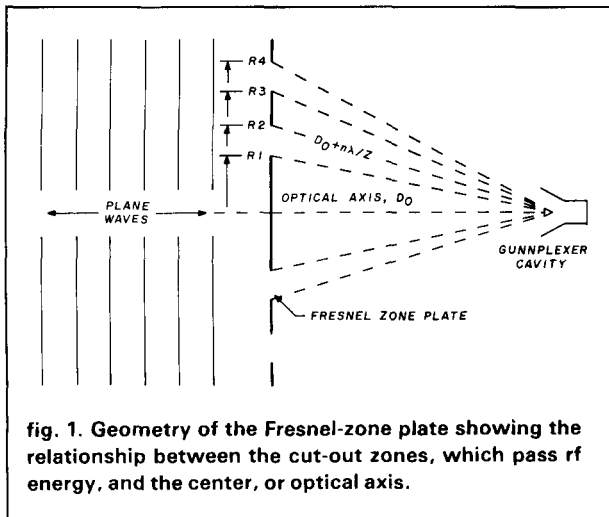

fig. 1. Geometry of the Fresnel-zone plate showing the relationship between the cut-out zones, which pass rf energy, and the center, or optical axis.

parabolic reflecting antenna to get some antenna gain. Some of the disadvantages of parabolic reflectors are that they are expensive, difficult to construct to the required tolerances, and difficult to mount or move because of their weight. This article describes an alternative antenna that yields results comparable to a parabola, yet is inexpensive and lightweight. Such an antenna is a Fresnel-zone plate.

description

The Fresnel-zone plate consists of a flat sheet of material that is opaque to 10.4-GHz energy (aluminum or copper foil) with concentric circular zones cut out to pass rf. The zones are spaced such that each zone is one-half wavelength greater in path length from the plate to the Gunnplexer cavity, out from the center zone, which is a straight-line path (fig. 1). The result is that each zone passes rf spaced one wavelength and adds constructively to the intensity of the rf at the focal point. The effect of the plate is to collimate the rf during transmit and focus it during receive, much like an ordinary optical converging lens.

geometry

To see how a Fresnel-zone plate works and to calculate the radii of the zones, refer to fig. 2. The outer edge of the n th zone is shown as R_n . According to the Fresnel diffraction theory, a wave that follows the path $L-R_n-F$ arrives $n\lambda/2$ out of phase with a wave that travels the path $L-O-F$. To express this mathematically, we say:

$$(S_n + S_0) - (d_n + D_0) = n\lambda/2 \quad (1)$$

With a little trigonometry we find that:

$$S_n = \sqrt{(R_n^2 + S_0^2)} \quad (2)$$

and
$$d_n = \sqrt{(R_n^2 + D_0^2)} \quad (3)$$

and using binomial expansion yields

$$S_n = S_0 + \frac{R_n^2}{2S_0} \quad (4)$$

and

$$d_n = D_0 + \frac{R_n^2}{2D_0} \quad (5)$$

Substituting into eq. 1 yields

$$\left(\frac{1}{S_0} + \frac{1}{D_0}\right) = \frac{n\lambda}{R_n^2} \quad (6)$$

which is identical to the thin-lens equation so familiar in classical geometrical optics.

In this case the wave source at L is at some great distance from the point O , thus the waves incident upon the zone plate are very nearly plane-wave in shape. Hence S_0 approaches infinity and eq. 6 reduces to

$$R_n^2 = nD_0\lambda \quad (7)$$

A more precise equation can be derived from more terms in the expansion, which results in

$$R_n^2 + D_0^2 = (D_0 + n\lambda/2)^2 \quad (8)$$

Thus, the radius of the n th zone is given by

$$R_n = \sqrt{nD_0\lambda + \frac{n^2\lambda^2}{4}} \quad (9)$$

From the principle of reciprocity, during transmit a point source at F would produce an almost plane wavefront on the opposite side of the zone plate. The system thus behaves as a collimating and focusing lens for transmitting and receiving respectively.

The dimensions for an experimental Fresnel-zone plate of ten zones, with a focal length of 100 centimeters at 10.4 GHz are given in table 1. Note that the area of each of the zones is constant, thus each zone will contribute equally to the sum intensity at the focal point. Suppose that we construct a zone plate that passes only the odd zones and blocks the

table 1. Dimensions for an experimental Fresnel-zone plate of ten zones with a focal length of 100 cm at 10 GHz.

radius of zone 1	17.0453 cm
radius of zone 2	24.1918 cm
radius of zone 3	29.7339 cm
radius of zone 4	34.4548 cm
radius of zone 5	38.6564 cm
radius of zone 6	42.4930 cm
radius of zone 7	46.0561 cm
radius of zone 8	49.4047 cm
radius of zone 9	52.5800 cm
radius of zone 10	55.6115 cm

HAL SEZ LOOK HERE!

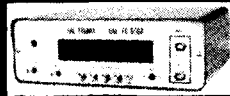

HAL 2304 MHz DOWN CONVERTERS (FREQ. RANGE 2000/2500 MHz)
2304 MODEL #1 KIT BASIC UNIT W/PREAMP LESS HOUSING & FITTINGS **\$49.95**
2304 MODEL #2 KIT (with preamp) **\$59.95**
2304 MODEL #3 KIT (with High Gain preamp) **\$69.95**

MODELS 2 & 3 WITH COAX FITTINGS IN & OUT AND WITH WEATHER-PROOFED DIE CAST HOUSINGS.
 FACTORY WIRED & TESTED **\$50 additional**
 BASIC POWER SUPPLY **\$19.95**
 POWER SUPPLY KIT FOR ABOVE WITH CASE **\$24.95**
 FACTORY WIRED & TESTED **\$34.95**

ANTENNAS & OTHER ACCESSORIES AVAILABLE. SEND FOR MORE INFO.
COMPLETE KITS: CONSISTING OF EVERY ESSENTIAL PART NEEDED TO MAKE YOUR COUNTER COMPLETE. **HAL-600A** 7-DIGIT COUNTER WITH FREQUENCY RANGE OF ZERO TO 600 MHz. FEATURES TWO INPUTS: ONE FOR LOW FREQUENCY AND ONE FOR HIGH FREQUENCY; AUTOMATIC ZERO SUPPRESSION. TIME BASE IS 1.0 SEC OR .1 SEC GATE WITH OPTIONAL 10 SEC GATE AVAILABLE. ACCURACY $\pm .001\%$. UTILIZES 10-MHz CRYSTAL 5 PPM. **COMPLETE KIT \$129**

HAL-300A 7-DIGIT COUNTER (SIMILAR TO 600A) WITH FREQUENCY RANGE OF 0-300 MHz. **COMPLETE KIT \$109**

HAL-50A 8-DIGIT COUNTER WITH FREQUENCY RANGE OF ZERO TO 50 MHz OR BETTER. AUTOMATIC DECIMAL POINT. ZERO SUPPRESSION UPON DEMAND. FEATURES TWO INPUTS: ONE FOR LOW FREQUENCY INPUT, AND ONE ON PANEL FOR USE WITH ANY INTERNALLY MOUNTED HALTRONIX PRE-SCALER FOR WHICH PROVISIONS HAVE ALREADY BEEN MADE. 1.0 SEC AND .1 SEC TIME GATES. ACCURACY $\pm .001\%$. UTILIZES 10-MHz CRYSTAL 5 PPM. **COMPLETE KIT \$109**

FREE: HAL-79 CLOCK KIT PLUS AN INLINE RF PROBE WITH PURCHASE OF ANY FREQUENCY COUNTER.

PRE-AMPLIFIERS

HAL 300 PRE (Pre-drilled G-10 board and all components) **\$14.95**
HAL 300 A/PRE (Same as above but with preamp) **\$24.95**
HAL 600 PRE (Pre-drilled G-10 board and all components) **\$29.95**
HAL 600 A/PRE (Same as above but with preamp) **\$39.95**

TOUCH TONE DECODER KIT

HIGHLY STABLE DECODER KIT. COMES WITH 2 SIDED, PLATED THRU AND SOLDER FLOWED G-10 PC BOARD, 7-567's, 2-7402, AND ALL ELECTRONIC COMPONENTS. BOARD MEASURES 3-1/2 x 5-1/2 INCHES. HAS 12 LINES OUT. ONLY **\$39.95**

NEW — 16 LINE DELUXE DECODER **\$69.95**

DELUXE 12-BUTTON TOUCHTONE ENCODER KIT UTILIZING THE NEW ICM 7206 CHIP. PROVIDES BOTH VISUAL AND AUDIO INDICATIONS! COMES WITH ITS OWN TWO-TONE AND DIZED ALUMINUM CABINET. MEASURES ONLY 2-3/4" x 3-3/4". COMPLETE WITH TOUCH-TONE PAD, BOARD, CRYSTAL, CHIP AND ALL NECESSARY COMPONENTS TO FINISH THE KIT. **PRICED AT \$29.95**

NEW — 16 LINE DELUXE ENCODER **\$39.95**

ACCUKEYER (KIT) THIS ACCUKEYER IS A REVISED VERSION OF THE VERY POPULAR WB4VVF ACCUKEYER ORIGINALLY DESCRIBED BY JAMES GARRETT, IN QST MAGAZINE AND THE 1975 RADIO AMATEUR'S HANDBOOK. **\$16.95**

ACCUKEYER — MEMORY OPTION KIT PROVIDES A SIMPLE, LOW COST METHOD OF ADDING MEMORY CAPABILITY TO THE WB4VVF ACCUKEYER. WHILE DESIGNED FOR DIRECT ATTACHMENT TO THE ABOVE ACCUKEYER, IT CAN ALSO BE ATTACHED TO ANY STANDARD ACCUKEYER BOARD WITH LITTLE DIFFICULTY. **\$16.95**

BUY BOTH THE MEMORY AND THE KEYS AND **SAVE**. COMBINED PRICE ONLY **\$32.00**

PRE-AMPLIFIER

HAL-PA-19 WIDE BAND PRE-AMPLIFIER, 2-200 MHz BANDWIDTH (-3dB POINTS), 19 dB GAIN. **FULLY ASSEMBLED AND TESTED \$8.95**

CLOCK KIT — HAL 79 FOUR-DIGIT SPECIAL — \$7.95. OPERATES ON 12-VOLT AC (NOT SUPPLIED). PROVISIONS FOR DC AND ALARM OPERATION

6-DIGIT CLOCK • 12/24 HOUR

COMPLETE KIT CONSISTING OF 2 PC G-10 PRE-DRILLED PC BOARDS, 1 CLOCK CHIP, 6 FND COMM., CATH. READOUTS, 13 TRANS., 3 CAPS, 9 RESISTORS, 5 DIODES, 3 PUSH-BUTTON SWITCHES, POWER TRANSFORMER AND INSTRUCTIONS. DON'T BE FOOLED BY PARTIAL KITS WHERE YOU HAVE TO BUY EVERYTHING EXTRA. **PRICED AT \$12.95**

CLOCK CASE AVAILABLE AND WILL FIT ANY ONE OF THE ABOVE CLOCKS. REGULAR PRICE \$6.50 BUT ONLY **\$4.50 WHEN BOUGHT WITH CLOCK.**

SIX-DIGIT ALARM CLOCK KIT FOR HOME, CAMPER, RV, OR FIELD-DAY USE. OPERATES ON 12-VOLT AC OR DC, AND HAS ITS OWN 60-Hz TIME BASE ON THE BOARD. COMPLETE WITH ALL ELECTRONIC COMPONENTS AND TWO-PIECE, PRE-DRILLED PC BOARDS. BOARD SIZE 4" x 3". COMPLETE WITH SPEAKER AND SWITCHES. IF OPERATED ON DC, THERE IS NOTHING MORE TO BUY. **PRICED AT \$16.95**

*TWELVE-VOLT AC LINE CORD FOR THOSE WHO WISH TO OPERATE THE CLOCK FROM 110-VOLT AC. **\$2.50**

SHIPPING INFORMATION — ORDERS OVER \$25.00 WILL BE SHIPPED POSTPAID EXCEPT ON ITEMS WHERE ADDITIONAL CHARGES ARE REQUESTED. ON ORDERS LESS THAN \$25.00 PLEASE INCLUDE ADDITIONAL \$2.00 FOR HANDLING AND MAILING CHARGES. SEND SASE FOR FREE FLYER.

DISTRIBUTOR FOR
Aluma Tower • AP Products
 (We have the new Hobby-Blox System)

HAL-TRONIX

P. O. BOX 1101
 SOUTHGATE, MICH. 48195
 PHONE (313) 285-1782

"HAL"
 HAROLD C. NOWLAND
 W8ZXH

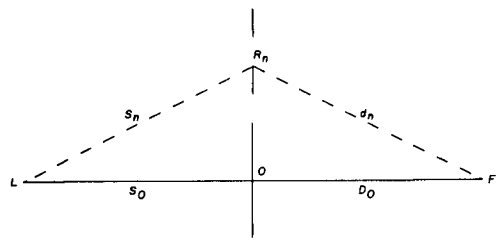

fig. 2. The Fresnel-zone plate is at O , the Gunnplexer is at F , and the contact station is at L . When the contact station is at a large distance (more than 10 wavelengths), the distance S_0 approaches infinity, and the rf wave at O appears as a plane wave.

even zones. The amplitude, E , at the focal point will be

$$E_T = E_1 + E_3 + E_5 + E \dots + (2n-1) \quad (10)$$

If we construct a plate that passes the first 10 odd zones, the sum is $10 E_1$. The incident wavefront gives $1/2 E_1$, so the amplitude at the focal point, F , will be increased 20 times. The intensity is therefore increased 400 times, or 26 dB. Larger zone plates and greater gains are possible as long as the focal point aberrations are less than the depth of the Gunnplexer cavity.

construction

The first Fresnel-zone plate antenna I constructed was made from art matte board covered with aluminum foil and the radii cut out with a knife. Several "spokes" were left in the board to support the inner zones. Subsequent plates have been made with aluminum sheet metal. The resulting antenna has been tested with Doppler-shifted carriers and has confirmed the calculated focal length and gain.

It might be pointed out that modifications of the zone radii would make it possible to make a plate that was not flat and could thus be incorporated into the various shapes of aircraft or other vehicles. In either case, flat or otherwise, the dimensions required for a zone plate are not nearly as tight as those for a parabola, and the resulting antenna is much lighter.

bibliography

- Fisk, James R., W1HR, "10-GHz Gunnplexer Transceivers — Construction and Practice," *ham radio*, January, 1979, page 26.
- Fisk, James R., W1HR, "Solid-State Microwave Generators," *ham radio*, April, 1977, page 10.
- Hecht, Eugene, and Zajac, Alfred, *Optics*, Addison-Wesley Publishing Company, 1975, pages 375-376.
- Hirschelmann, Klaus H., DJ700, "10-GHz Transceiver for Amateur Microwave Communications," *ham radio*, August, 1978, page 10.
- Jenkins, Francis A., and White, Harvey E., *Fundamentals of Optics*, McGraw-Hill Book Company, 1976, pages 378-386.

ham radio

mail this card today

YES, please send me my **FREE** Heathkit Catalog of easy-and-fun-to-build electronic kits. I am not receiving your catalogs now, and I certainly would like to get them regularly.

FREE HEATHKIT CATALOG

name _____
(Please Print)

address _____

city _____

state _____ **zip** _____

Free
HEATHKIT
CATALOG

PLACE
STAMP HERE
Post Office
will not
deliver mail
without postage

Heath Company
Benton Harbor, MI 49022

Attn: Recruiters

**Expose Your
Recruitment Ads
to the most
Technical
Audience of Radio
Hams Available**

Here's how

Are you looking for a technically qualified person and find that few are available locally? Broaden your search by running an ad in HAM RADIO Magazine. HAM RADIO's readers are the most technically qualified. Over 60% are actively involved in one or more areas of the electronics industry. Their skills range from bench technician to design engineer. Here are some of the benefits from running an ad in HAM RADIO Magazine.

- National coverage at an affordable price
- Specially segmented audience
- Active Hams who do more than just read about electronics — they participate in it

Call today for more information about placing an ad in HAM RADIO. *Get the person you want!*

**CALL TODAY
(603) 878-1441
Ham Radio
Box 0
Greenville, NH 03048**

FREE!



**THE IMPORTANT
CATALOG FOR
THE ACTIVE HAM**

Hi-Tech Stations:

From QRP to SSB, there's more for the Ham at Heath. Acclaimed as one of the world's finest SSB/CW Transceivers, our phenomenal no-tune SB-104A and complete line of integrated Station Aids are advanced concepts in Ham technology.



Computer Operation:

"Micro"-enhanced ham shacks are the wave of this hobby's future. Pacesetter Amateur Radio enthusiasts are using computers to design antennas, plot beam headings, track OSCAR and transmit RTTY. Heath and the Ham, once again, are the perfect partners in this new adventure.



Guaranteed Courses:

Heathkit/Zenith Educational Courses are the low-cost, time-saving way to learn. We have comprehensive programs to help earn your Novice, General or Advanced Class licenses. You can't fail — Heath guarantees that you will pass! — or we'll refund the purchase price.



Service and Accessory

Equipment: Whether you need a test instrument for electronics service work, manufacturing and design or serious hobby applications, see us. All Heathkit instruments are units of high professional quality offering you extra-value capability. Like our new 20 MHz dual-trace portable oscilloscope, they're built to last and give you reliable results every time.



**SEE IT ALL IN THE
BIG, NEW HEATHKIT
CATALOG** and read about our entire line of electronic kits.

**SEND FOR YOURS
TODAY!**

If coupon is missing, write:
Heath Company,
Dept. 122-892,
Benton Harbor,
MI 49022

In Canada: Heath Co.,
1480 Dundas St. East,
Mississauga, ONT
L4X 2R7

Heathkit FREE CATALOG!

Please send my free Heathkit Catalog.
I am not currently receiving one.

Send to: **Heath Co., Dept. 122-892
Benton Harbor, MI 49022**

Name _____

Address _____

City _____ State _____

AM-424 _____ Zip _____

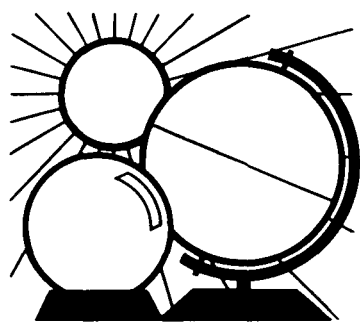

DX FORECASTER

Garth Stonehocker, KØRYW

last-minute forecast

The first of the month is expected to favor the lower frequencies for nighttime DX activities. DX conditions for the upper-frequency bands should improve during the third week, then round off and drop during the end of the last week. Solar radio flux is expected to be high during that time. Propagation disturbances from solar-flare activity of two to three days' duration are possible around the 15th and 25th. Also, a disturbed period may occur around the 5th from a coronal hole. Conditions will generally be poorer for hearing and working DX during these disturbances, but look for unusual DX locations to appear with weak, fading signals.

The lunar perigee, of interest to moonbounce DXers, will occur on the 24th of this month. An Aquarid meteor shower, of interest to meteor-scatter DXers, will show a maximum between May 4th and 6th, with a rate of 10 and 25 per hour for the Northern and Southern Hemispheres, respectively.

sporadic-E propagation

One of the major paths for excellent DX signals in the summer is short skip, or multiple short skips, on the higher frequency bands. Here we are in May, nearing summer. The end of May heralds the beginning of the sporadic-E (Es) propagation season. Es is

a thin layer of intense ionization about 60 miles (100 km) above the earth. It gives rise to strong, mirror-like signal reflections over the short-skip distance of 600 to 1200 miles (1000 to 2000 km). Signals remain strong from a half hour to a couple of hours on the average, as the name sporadic suggests, rather than all day long or all night as with other high-frequency propagation.

The highest frequency propagated by Es follows the sun across the sky; the highest probability of occurrence, however, is near sunrise and again around sunset. These two facets of Es affect short-skip openings differently. Openings on the higher-frequency bands occur near local noon-time and the lower bands tend to have openings near sunrise and sunset.

Now look at the best locations for these Es openings: since Es is related to the summer sun, the effect is in the Northern Hemisphere from June through September and in the Southern Hemisphere during their summer, December through March. The best Es is on either side of the geomagnetic equator; it's especially good where the geomagnetic equator has greatest separation from the geographic equator. These special areas are Southeast Asia in the Northern Hemisphere and South America in the Southern Hemisphere. The first is the best of the two because the E region ionospheric electric currents are

strongest there. Another location of prolific Es for short skip is the auroral oval at about 20 degrees around the geomagnetic pole. This Es is not a summer phenomenon, though; it's mainly equinoctial. During geomagnetic disturbances, particles from the solar wind entering the polar regions penetrate to the E and F regions producing ionization (aurora) there. It is associated with auroral scatter VHF openings which intrigue DXers who work east/west paths to Europe and Japan using this mode.

To look for Es openings on the higher-frequency bands, monitor beacons on 6, 10, and 15 meters, WWV frequencies, and CB channel 19. Also check TV channels 2 through 5 for 6- and 2-meter openings. The lower bands don't need beacon monitoring, since Es openings (sunrise and sunset) are available most nights. Remember: couple your antenna to the ionosphere with takeoff angles of 5-10 degrees (see the January, 1981, DX Forecaster).

band-by-band summary

Six meters will provide very good openings during high solar flux to South Africa, Australia, and New Zealand around local noontime. Look for possible Es short-skip by monitoring TV.

Ten, fifteen, and twenty meters will have DX from most areas of the world during daylight and into the evening almost every day, either long skip to 2500 miles (4000 km) or Es short skip to 1250 miles (2000 km) per hop. The length of daylight is now approaching maximum, providing hours of good DXing.

Forty, eighty, and one-sixty meters are the night DXer's bands. On many nights 40 meters will be the only usable band because of thunderstorm QRN, but signal strengths via Es short skip may overcome the static when Es is available. Although Es is scarcely available in May, it should be better next month.

ham radio

GMT	WESTERN USA									
	N	NE	E	SE	S	SW	W	NW	PDT	
0000	—	20	—	15	10	10	10	15	5:00	—
0100	—	20	20	10	15	10	10	15	6:00	—
0200	—	20	20	10	15	10	10	15	7:00	—
0300	—	20	20	15	15	15*	10	15	8:00	—
0400	—	20	40*	15	15	15	15*	15	9:00	—
0500	—	20	40*	15	20	15	15*	20*	10:00	—
0600	—	20	40	15	20	15	15	20*	11:00	—
0700	—	20	20	20	20	15	15	20	12:00	—
0800	—	20	20	20	20	15	15	20	1:00	—
0900	—	20	20	20	20	15	15	20	2:00	—
1000	—	20	—	20	20	20*	15	20	3:00	—
1100	—	20	—	20	40	20	20	20	4:00	—
1200	—	20	—	20	40	20	20	20	5:00	—
1300	—	20	20	20	40	20	20	20	6:00	—
1400	—	20	20	15	40	20	20	20	7:00	—
1500	—	20	20	15	—	—	—	20	8:00	—
1600	—	20	20	10	—	—	—	20	9:00	—
1700	—	15	15	10	—	—	—	15	10:00	—
1800	—	15	15	15	—	—	—	15	11:00	—
1900	—	15	15	15	—	—	—	15	12:00	—
2000	—	15	15	15*	—	—	—	15	1:00	—
2100	—	—	—	15	—	—	—	15	2:00	—
2200	—	20	—	15	—	—	—	15	3:00	—
2300	—	20	—	15	10	10	10	15	4:00	—

MDT	MID USA									
	N	NE	E	SE	S	SW	W	NW	PDT	
6:00	—	20	15	15	15	10	10	15	6:00	—
7:00	15	20	20*	15*	15	10	10	15	7:00	—
8:00	15	20	20	15	15	15*	15	15	8:00	—
9:00	15	20	40	15	15	15	15	15	9:00	—
10:00	—	20	40	15	20*	15	15	15	10:00	—
11:00	—	20	40	20	20	15	15	20	11:00	—
12:00	—	20	20	20	20	20	15	20	12:00	—
1:00	—	20	20	20	20	20	15	20	1:00	—
2:00	—	20	20	20	20	20	20	20	2:00	—
3:00	—	20	—	20	40	20	20	20	3:00	—
4:00	—	20	—	20	40	20	20	20	4:00	—
5:00	—	20	—	20	40	20	20	20	5:00	—
6:00	—	20	—	20	20	20	20	20	6:00	—
7:00	—	20	20	15	—	—	—	20	7:00	—
8:00	—	20	20	15	—	—	—	20	8:00	—
9:00	—	20	15	15	—	—	—	20	9:00	—
10:00	—	20	15	15	—	—	—	15	10:00	—
11:00	—	15	15	15	—	—	—	15	11:00	—
12:00	—	15	15	15	—	—	—	15	12:00	—
1:00	—	15	15	10	—	—	—	15	1:00	—
2:00	—	15	15	10	—	—	—	15	2:00	—
3:00	—	15	15	10	—	—	—	15	3:00	—
4:00	—	20	—	10	—	—	—	15	4:00	—
5:00	—	20	—	10	10	10	10	15	5:00	—
6:00	—	20	—	10	15	10	10	15	6:00	—

EDT	EASTERN USA									
	N	NE	E	SE	S	SW	W	NW	PDT	
8:00	15	20	15	15	20	15	10	15	8:00	—
9:00	15	20	20	15	20	15	15*	20	9:00	—
10:00	—	20	40*	15	20	15	15	20	10:00	—
11:00	—	20	40	15	20	—	15	20	11:00	—
12:00	—	20	40	20	20	—	15	—	12:00	—
1:00	—	20	20	20	20	—	20*	—	1:00	—
2:00	—	20	20	20	40	20	20	—	2:00	—
3:00	—	20	20	20	40	20	20	—	3:00	—
4:00	—	20	—	—	40	20	20	—	4:00	—
5:00	—	20	—	—	40	20	20	—	5:00	—
6:00	—	20	—	—	40	20	20	—	6:00	—
7:00	—	20	—	—	20	20	20	—	7:00	—
8:00	—	—	15	20	—	20	20	—	8:00	—
9:00	—	—	15	20	—	20	20	—	9:00	—
10:00	—	—	15	15	—	—	—	—	10:00	—
11:00	—	—	15	15	—	—	—	—	11:00	—
12:00	—	—	15	15	—	—	—	—	12:00	—
1:00	—	—	15	15	—	—	—	—	1:00	—
2:00	—	—	15	15	—	—	—	—	2:00	—
3:00	—	—	15	15	—	—	—	—	3:00	—
4:00	—	—	15	15	—	—	—	—	4:00	—
5:00	—	—	15	15	—	—	—	—	5:00	—
6:00	—	—	15	15	—	—	—	—	6:00	—
7:00	—	—	15	15	—	—	—	—	7:00	—

*Look at next higher band for possible openings.

Dyna "mite."



Photo shown is TR-7730 in 16-key autopatch UP/DOWN microphone version.

Miniaturized, 5 memories, memory/band scan

TR-7730

The TR-7730 is an incredibly compact, reasonably priced, 25-watt, 2-meter FM mobile transceiver with five memories, memory scan, automatic band scan, and other convenient operating features. The TR-7730 is available in two variations: a 16-key autopatch UP/DOWN microphone (MC-46) version, and a basic UP/DOWN microphone version.

TR-7730 FEATURES:

- **Smallest ever Kenwood mobile**
Measures only 5-3/4 inches wide, 2 inches high, and 7-3/4 inches deep, and weighs only 3.3 pounds. Mounts even in the smallest subcompact car, and is an ideal combination with the equally compact TR-8400 synthesized 70-cm FM mobile transceiver.
- **25 watts RF output power**
HI/LOW power switch selects 25-W or 5-W output.

- **Five memories**
May be operated in simplex mode or repeater mode with the transmit frequency offset ± 600 kHz. The fifth memory stores both receive and transmit frequency independently, to allow operation on repeaters with nonstandard splits. Memory backup terminal on rear panel.
- **Memory scan**
Automatically locks on busy memory channel and resumes when signal disappears or when SCAN switch is pushed. Scan HOLD or microphone PTT switch cancels scan.
- **Automatic band scan**
Scans entire band in 5-kHz or 10-kHz steps and locks on busy channel. Scan resumes when signal disappears or when SCAN switch is pushed. Scan HOLD or microphone PTT switch cancels scan.
- **Extended frequency coverage**
Covers 143,900-148,995 MHz in switchable 5-kHz or 10-kHz steps.
- **UP/DOWN frequency control from microphone**
Manual UP/DOWN scan of entire band in

5 kHz or 10 kHz steps is possible when using either autopatch or basic UP/DOWN microphone versions.

- **Offset switch**
Allows VFO and four of five memory frequencies to be offset ± 600 kHz for repeater access or simplex.
- **Four-digit LED frequency display**
Indicates receive and transmit frequency.
- **S/RF bar meter and LED indicators**
Bar meter of multicolor LEDs shows S/RF levels. Other LEDs indicate BUSY, ON AIR, and REPEATER offset.
- **Tone switch**

Optional accessories:

- **MC-46** 16-key autopatch UP/DOWN microphone
- **SP-40** compact mobile speaker
- **KPS-7** fixed-station power supply

More information on the TR-7730 and TR-8400 is available from all authorized dealers of Trio-Kenwood Communications 1111 West Walnut Street Compton, California 90220

Synthesized 70-cm FM mobile rig

TR-8400

- **Synthesized coverage of 440-450 MHz**
Covers upper 10 MHz of 70-cm band in 25-kHz steps, with two VFOs.
- **Offset switch**
For ± 5 MHz transmit offset on both VFOs and four of five memories, as well as simplex operation. Fifth memory allows any other offset by memorizing receive and transmit frequencies independently.
- **DTMF autopatch terminal**
On rear panel, for connecting DTMF (dual-tone multifrequency) touch pad (for

accessing autopatches) or other tone-signaling device.

- **HI/LOW RF output power switch**
Selects 10 watts or 1 watt output.
- **Virtually same size as TR-7730**
Perfect companion for TR-7730 in a compact mobile arrangement.
- **Other features similar to TR-7730**
Five memories, memory scan, automatic band scan (in 25-kHz steps), UP/DOWN manual scan, four-digit LED receive frequency display (also shows transmit frequency in memory 5), S/RF bar meter and LED indicators, tone switch, and same optional accessories.

KENWOOD
...pacesetter in amateur radio



Specifications and prices are subject to change without notice or obligation.



R-1000
\$30.00 OFF



KENWOOD

...pacesetter in amateur radio

\$ CASH NOW! \$

ASK YOUR DEALER FOR DETAILS



TR-7730
\$30.00 OFF
WITH OR WITHOUT
MC-46



TS-130SE or
TS-130S
\$15.00 OFF



TR-8400
\$30.00 OFF



TS-530S
\$15.00 OFF

Participating Trio-Kenwood Authorized Dealers:

ALABAMA
Long's Electronics
Birmingham, AL 35233
(205) 252-7589

ALASKA
Reliable Electronics
Anchorage, AK 99503
(907) 279-5100

ARIZONA
Power Communications
Phoenix, AZ 85015
(602) 241-9288

CALIFORNIA
Ham Radio Outlet
Burlingame, CA 94010
(415) 342-5757

Ham Radio Outlet
San Diego, CA 92123
(714) 560-4900

Ham Radio Outlet
Van Nuys, CA 91401
(213) 988-2212

Ham Radio Outlet*
Oakland, CA 94609
(415) 451-5757

Ham Radio Outlet
Anaheim, CA 92801
(714) 761-3033

Henry Radio, Inc.
Los Angeles, CA 90025
(213) 820-1234

Henry Radio & Electronics
Anaheim, CA 92801
(714) 772-9200

COLORADO
CW Electronic Sales Co.
Denver, CO 80202
(303) 832-1111

FLORIDA
Amateur Electronic Supply
Orlando, FL 32803
(305) 894-3238

Amateur Radio Center
Miami, FL 33137
(305) 573-8383

HAWAII
Honolulu Electronics
Honolulu, HI 96814
(808) 949-5564

IDAHO
Ross Distributing Co.
Preston, ID 83263
(208) 852-0830

ILLINOIS
Erickson Communications
Chicago, IL 60630
(312) 631-5181

INDIANA
Graham Electronics
Indianapolis, IN 46204
(317) 635-5453

Hoosier Electronics
Terre Haute, IN 47802
(812) 238-1456

Kryder Electronics
Fort Wayne, IN 46815
(219) 485-6434

IOWA
HI, Incorporated
Council Bluffs, IA 51502
(712) 323-0142

KANSAS
Associated Radio Comm.
Overland Park, KS 66204
(913) 381-5901

MARYLAND
Amateur Electronic Supply
Wheaton, MD 20902
(301) 946-1088

The Comm. Center
Laurel, MD 20810
(301) 792-0600

MICHIGAN
Radio Supply & Engineering
Detroit, MI 48201
(313) 435-5660

MINNESOTA
Midwest Amateur Radio Supply, Inc.*
Minneapolis, MN 55142
(612) 521-4662

MISSOURI
Ham Radio Center
St. Louis, MO 63132
(314) 993-6060

Henry Radio Company
Butler, MO 64730
(816) 679-3127

MidCom Electronics
St. Louis, MO 63144
(314) 961-9990

Missouri Radio Center*
Kansas City, MO 64150
(816) 741-8118

MONTANA
Conley Radio Supply
Billings, MT 59101
(406) 259-9554

NEBRASKA
Communications Center
Lincoln, NB 68508
(402) 476-7331

NEVADA
Amateur Electronic Supply*
Las Vegas, NV 89106
(702) 647-3114

NEW HAMPSHIRE
Tuft's Radio & Elect. Supply
Hudson, NH 03051
(603) 883-5005

NEW MEXICO
Electronic Module
Hobbs, NM 88240
(505) 397-3022

NEW YORK
Adirondack Radio Supply
Amsterdam, NY 12010
(518) 842-8350

Harrison Radio Corp.
Long Island, NY 11735
(516) 293-7990

Radio World
Onskany, NY 13424
(315) 736-0184

OHIO
Amateur Electronic Supply
Wickliffe, OH 44092
(216) 585-7388

Srepro Electronics
Dayton, OH 45404
(513) 224-0871

Universal Amateur Radio, Inc.
Reynoldsburg, OH 43068
(614) 866-4267

OKLAHOMA
Derrick Electronics*
Broken Arrow, OK 74012
(918) 251-9923

Radio, Inc.
Tulsa, OK 74119
(918) 587-9123

OREGON
Portland Radio Supply
Portland, OR 97205
(503) 228-8647

PENNSYLVANIA
Hamtronics/Trevose
Trevose, PA 19047
(215) 357-1400

J.R.S. Distributors
York, PA 17404
(717) 854-8624

SOUTH CAROLINA
G.I.S.M.O. Communications
Rockhill, SC 29730
(803) 366-7157

SOUTH DAKOTA
Burghardt Amateur Radio Center
Watertown, SD 57201
(605) 866-7314

TENNESSEE
Amateur Radio Supply of Nashville
Madison, TN 37115
(615) 868-4956

Memphis Amateur Electronics
Memphis, TN 38108
(901) 683-9125

TEXAS
Douglas Electronics
Corpus Christi, TX 78404
(512) 883-5103

Electronics Center
Dallas, TX 75201
(214) 526-2023

Hardin Electronics
Ft. Worth, TX 76112
(817) 429-9761

Madison Electronics
Houston, TX 77010
(713) 658-0268

Kennedy Associates
San Antonio, TX 78222
(512) 333-6110

WASHINGTON
A-B-C Communications
Seattle, WA 98155
(206) 364-8300

Amateur Radio Supply Co.
Seattle, WA 98108
(206) 767-3222

C-COMM*
Seattle, WA 98107
(206) 784-7337

WISCONSIN
Amateur Electronic Supply
Milwaukee, WI 53216
(414) 442-4200



Use this **KENWOOD BONUS BUCKS** coupon, when presented to any factory authorized dealer of **TRIO-KENWOOD COMMUNICATIONS** products, may be used as partial payment in the amount of \$30.00 toward the purchase of any new **KENWOOD** model R-1000, TR-8400, or TR-7730 with MC-46 or basic UP/DOWN microphone, or may be used as partial payment in the amount of \$15.00 toward the purchase of any new **KENWOOD** model TS-130S, TS-130SE, or TS-530S amateur radio product. The purchase must be made during the period March 1, through June 15, 1982. The customer must present a separate coupon (one only) for each of the listed models being purchased. Additional coupons are available from our authorized dealers. **TRIO-KENWOOD** assumes no responsibility for the inability of any of its dealers or of itself to deliver any specific product within the period specified in the foregoing. Offer valid only in the U.S.A. Void where taxed or prohibited by law. Resellers are not eligible to participate in this program. This coupon is a part of **TRIO-KENWOOD COMMUNICATIONS** "BONUS BUCKS" sales program. It has no value unless submitted in compliance with the rules of that program prior to June 15, 1982.

		/ /1982	
Model Purchased		Date Purchased	
Dealer Name: _____			
Customer Name: _____		Call Sign: _____	
Address: _____			
City: _____		State/Zip: _____	
Customer Signature: _____			

KENWOOD
TRIO-KENWOOD COMMUNICATIONS
1111 West Walnut, Compton, California 90220

Good Mar. 1 through Jun. 15, 1982.

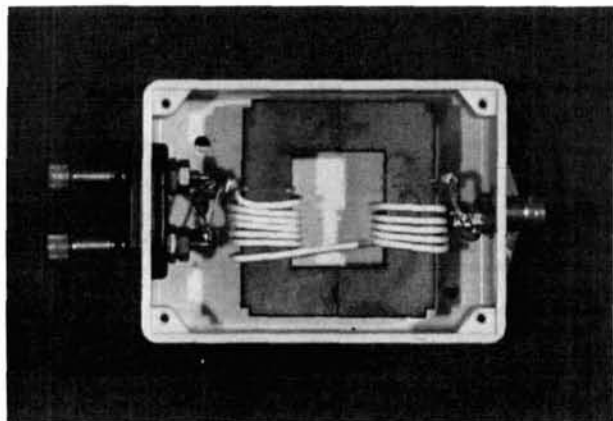

another balun design

Discarded TV-set
flyback transformer cores
can be made
into broadband baluns
at minimal cost

Modern Amateur equipment is designed for unbalanced coaxial-cable output. The proper way to connect this gear to a balanced load, such as a dipole antenna, is to place a balancing network, or *balun*, between the coax transmission line and the antenna. The balun ensures proper operation of the antenna, prevents antenna currents from appearing on the coax-cable shield, and keeps rf voltages from appearing on the outside of the rig.

Theoretically, baluns can be constructed for any given impedance transformation, but standard transformation ratios are 1:1 and 4:1. The 1:1 balun transforms a 50-ohm unbalanced coax transmission line, for example, to a balanced 50-ohm load, or a 75-ohm unbalanced line to a 75-ohm balanced load. The 4:1 balun may be used to transform 300-ohm balanced line, such as twinlead, to a 75-ohm unbalanced coax line.

the flyback balun

Many balun designs have been described in the Amateur literature. The two designs presented here are in no way unique except in their use of ferrite cores from old TV-set flyback transformers.

Any discarded TV set has a flyback transformer (sometimes known as a horizontal-output transform-

er). This transformer, which has a ferrite core, is designed to operate at the horizontal sweep frequency of 15.75 kHz, and must handle harmonics extending to 1 or 2 MHz. The transformer is easy to disassemble, as the ferrite core is always in the form of two U-shaped halves. High-*Q* coils for low or medium frequencies can be made from this high-permeability ferrite, but in the upper high-frequency region, the core material is too lossy to form coils of any appreciable *Q*. This fact has probably deterred Amateurs from using these cores for baluns. (One exception is W6SJK's article, "Three Baluns for a Buck," 73 magazine, August, 1979, page 102.) However, the baluns described here don't require high-*Q* ferrite cores for their performance. This is because, at high frequencies, the magnetic field does not penetrate very far into the core, so core losses remain small.

the 4:1 balun

Essentially, the 4:1 balun consists of a pair of two-wire transmission lines wound into coils as shown in fig. 1. The air-core version of this type of balun was known as "elevator coils" in the early days of television. Its operation can be understood if we assume for the moment that both lines are of 100-ohm characteristic impedance and without standing waves. Since the two 100-ohm lines are connected in parallel at the input, they will be matched to 50-ohm coax. At the output, however, the two 100-ohm lines are connected in series to produce 200 ohms, balanced to ground. The purpose of the ferrite cores is to give the bifilar coils enough inductance to isolate the input from the output and prevent a low-impedance path across the input or output terminals.

By Fred Brown, W6HPH, 1169 Los Corderos,
Lake San Marcos, California 92069

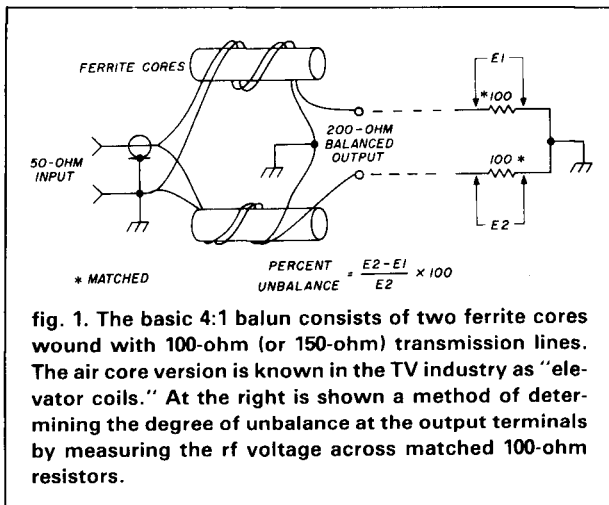

fig. 1. The basic 4:1 balun consists of two ferrite cores wound with 100-ohm (or 150-ohm) transmission lines. The air core version is known in the TV industry as "elevator coils." At the right is shown a method of determining the degree of unbalance at the output terminals by measuring the rf voltage across matched 100-ohm resistors.

The transformation of 75-ohm coax to 300-ohm twinlead ideally would require bifilar coils wound with 150-ohm transmission lines. Since neither 100- nor 150-ohm twinlead was available, the 4:1 balun coils were made with No. 24 (0.5 mm) vinyl zip cord. This wire is readily available in retail stores; often it is sold as "speaker wire." Q-meter measurements indicate its characteristic impedance to be about 156 ohms.

Vinyl, unfortunately, is quite lossy at radio frequencies. A better choice would have been twisted pair made of Teflon or polyethylene insulated wire. Ideally, the insulation should be of a thickness that give a characteristic impedance in the vicinity of 100 or 150 ohms, but below VHF the impedance is not particularly critical because the lines are short in terms of a wavelength. Another possibility is 72-ohm receiving twinlead.

Construction details are shown in the photograph. The size of the flyback transformer core is not particularly important; the one used here had a cross-sectional diameter of about 5/8 inch (16 mm). The two

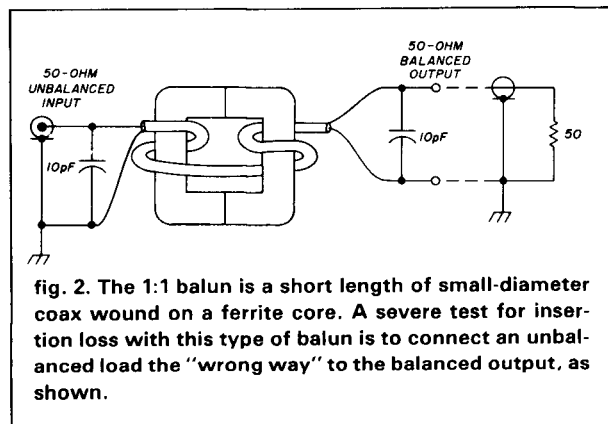

fig. 2. The 1:1 balun is a short length of small-diameter coax wound on a ferrite core. A severe test for insertion loss with this type of balun is to connect an unbalanced load the "wrong way" to the balanced output, as shown.

bifilar coils are twelve turns each; they should be wound in the same direction and should be as identical as possible. The coil ends can be anchored to the ferrite with epoxy cement. Leads to the input and output connectors should be short and of equal length for both coils. When wound, the two cores can be fastened to the wooden base by cementing the core faces to the wood with epoxy or super glue. If a metal box is used, the core faces should be spaced away from the metal by nonmetallic spacers of at least a few millimeters thickness.

1:1 balun

The basic design of the 1 to 1 balun, fig. 2, has been described previously by Joe Reisert, W1JR.¹ This is a "choke" type of balun: a magnetic core wound with small-diameter coax. Losses are very low in this type of balun, and it is ideal for connecting coax to a dipole antenna.

The toroidal ring is formed by cementing together the two U-shaped halves of the flyback transformer core. The coaxial coil is wound in two halves on opposite sides of the core; each half is six turns. Be sure to adhere to the winding direction shown in fig. 2. The ends can be secured to the core by tying with short lengths of nylon fishline.

The balun shown was wound with RG-196A/U 50-ohm coax; if 75 ohms impedance is desired, RG-187A/U is recommended. In either case, since the dielectric is Teflon rather than polyethylene, the power-handling capacity of this smaller coax is the same as RG-58 — about 400 watts at 30 MHz. For Amateur use this means the legal power limit below 30 MHz, because the duty cycle for CW is only 50 percent, and your kilowatt final is not going to exceed 80 percent efficiency. (Just don't hold that key down too long!) SSB has an even lower duty cycle. If RG-174/U is used the power rating will have to be reduced to 100 watts continuous at 30 MHz.

results

When the baluns were properly terminated, input SWR measured less than 1.1 on all bands, 160 through 10 meters. Measured insertion loss is given in fig. 3. Accurate measurement of insertion loss in the 1/10 dB area is never easy, but these curves are believed to be fairly accurate. The 4:1 balun has a power loss of 6.4 percent at 29 MHz. When 200 watts of rf were run through this balun, the zip cord became warm to the touch, revealing that the vinyl insulation was the cause of the power loss. Two hundred watts is about the maximum continuous power that the zip cord will handle at 10 meters, although higher power could be run intermittently, or at lower frequencies. As mentioned before, much better performance could be expected from Teflon-insulated

The ultimate team... the new **Drake "Twins"**

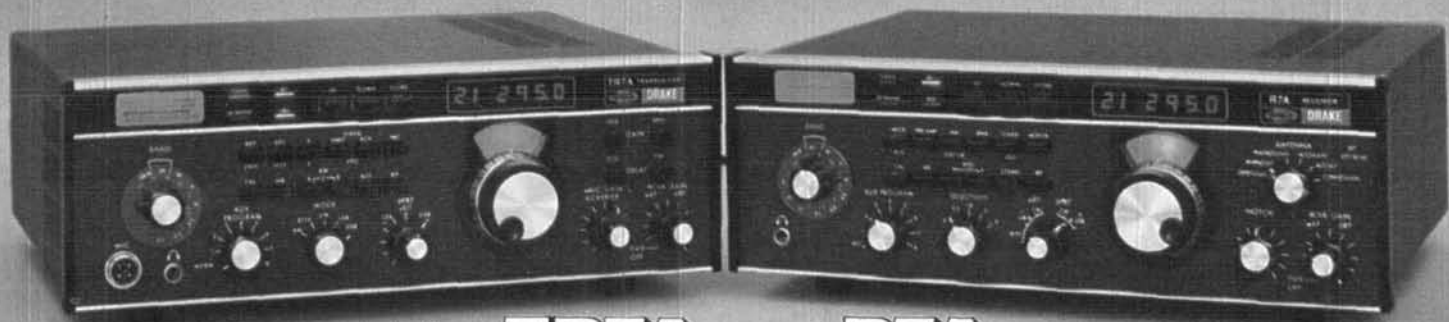

The **TR7A** and **R7A** offer performance and versatility for those who demand the ultimate!

TR7A Transceiver

- **CONTINUOUS FREQUENCY COVERAGE** — 1.5 to 30 MHz full receive coverage. The optional AUX7 provides 0 to 1.5 MHz receive plus transmit coverage of 1.8 to 30 MHz, for future Amateur bands, MARS, Embassy, Government or Commercial frequencies (proper authorization required).

- **Full Passband Tuning (PBT)** enhances use of high rejection 8-pole crystal filters.

New! Both 2.3 kHz ssb and 500 Hz cw crystal filters, and 9 kHz a-m selectivity are standard, plus provisions for two additional filters. These 8-pole crystal filters in conjunction with careful mechanical/electrical design result in realizable ultimate rejection in excess of 100 dB.

New! The very effective NB7 Noise Blanker is now standard.

New! Built in lightning protection avoids damage to solid-state components from lightning induced transients.

New! Mic audio available on rear panel to facilitate phone patch connection.

- **State-of-the-art design** combining solid-state PA, up-conversion, high-level double balanced 1st mixer and frequency synthesis provided a no tune-up, broadband, high dynamic range transceiver.

R7A Receiver

- **CONTINUOUS NO COMPROMISE** 0 to 30 MHz frequency coverage.

- **Full passband tuning (PBT).**

New! NB7A Noise Blanker supplied as standard.

- **State-of-the-Art features** of the TR7A, plus added flexibility with a low noise 10 dB rf amplifier.

New! **Standard ultimate selectivity choices** include the supplied 2.3 kHz ssb and 500 Hz cw crystal filters, and 9 kHz a-m selectivity. Capability for three accessory crystal filters plus the two supplied, including 300 Hz, 1.8 kHz, 4 kHz, and 6 kHz. The 4 kHz filter, when used with the R7A's Synchro-Phase a-m detector, provides a-m reception with greater frequency response within a narrower bandwidth than conventional a-m detection, and sideband selection to minimize interference potential.

- **Front panel pushbutton control** of rf preamp, a-m/ssb detector, speaker ON/OFF switch, i-f notch filter, reference-derived calibrator signal, three agc release times (plus AGC OFF), integral 150 MHz frequency counter/digital readout for external use, and Receiver Incremental Tuning (RIT).

The "Twins" System

- **FREQUENCY FLEXIBILITY.** The TR7A/R7A combination offers the operator, particularly the DX'er or Contester, frequency control agility not available in any other system. The "Twins" offer the only system capable of no-compromise DSR (Dual Simultaneous Receive). Most transceivers allow some external receiver control, but the "Twins" provide instant transfer of transmit frequency control to the R7A VFO. The operator can listen to either or both receiver's audio, and instantly determine his transmitting frequency by

appropriate use of the TR7A's RCT control (Receiver Controlled Transmit). DSR is implemented by mixing the two audio signals in the R7A

- **ALTERNATE ANTENNA CAPABILITY.** The R7A's Antenna Power Splitter enhances the DSR feature by allowing the use of an additional antenna (ALTERNATE) besides the MAIN antenna connected to the TR7A (the transmitting antenna). All possible splits between the two antennas and the two system receivers are possible.

Specifications, availability and prices subject to change without notice or obligation.

See your Drake dealer or write
for additional information.



COMING SOON: New RV75 Synthesized VFO
Compatible with TR5 and 7-Line Xcvrs/Rcvrs

- Frequency Synthesized for crystal-controlled stability
- VRTO (Variable Rate Tuning Oscillator*) adjusts tuning rate as function of tuning speed.
- Resolution to 10 Hz
- Three programmable fixed frequencies for MARS, etc.
- Split or Transceive operation with main transceiver PTO or RV75

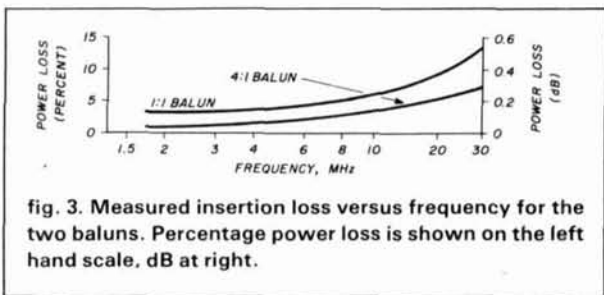

fig. 3. Measured insertion loss versus frequency for the two baluns. Percentage power loss is shown on the left hand scale, dB at right.

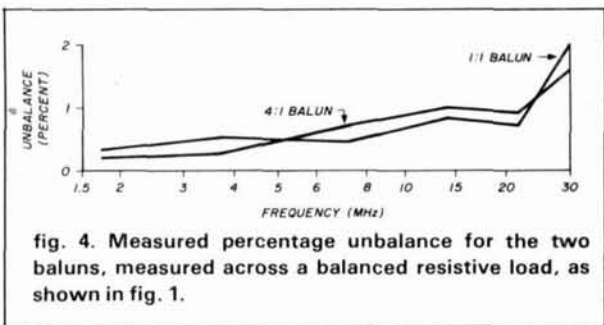

fig. 4. Measured percentage unbalance for the two baluns, measured across a balanced resistive load, as shown in fig. 1.

twisted pair. Insertion loss of the 4:1 balun measured 1 dB at 6 meters and about 3 dB at 2 meters.

The excellent results on 160 meters indicate that fewer turns could have been used on both baluns, which would reduce losses on the higher bands without much sacrifice of performance on 80 or 160 meters.

The 1:1 balun's insertion loss was measured by Joe Reisert's acid test; that is, by connecting the balanced output to an ordinary unbalanced-input wattmeter, with the *inner* conductor of the balun going to the *outer* conductor of the load, and *vice versa* (see fig. 2). As a result, most of the power loss shown in fig. 3 is radiation loss — not heat loss in the balun itself.

Initially the 1:1 balun showed an insertion loss of 3.5 dB on 2 meters. This high value was traced to reflections from the inductance of the half-inch-long leads that connect the RG-196 to the input and output connectors. The loss was decreased to 1 dB by soldering 10-pF capacitors, with the shortest possible leads, directly across the connectors.

Fig. 4 shows the degree of unbalance: $\frac{E_2 - E_1}{E_2}$, expressed in percent and measured for both baluns by the split-load method shown in fig. 1. Two matched 25-ohm resistors were used for the split load on the 1:1 balun.

reference

1. Joe Reisert, W1JR, "A Simple and Efficient Broadband Balun," *ham radio*, September, 1978, page 12.

ham radio

State of the art



by K.V.G.

9 MHz CRYSTAL FILTERS

MODEL	Application	Bandwidth	Poles	Price
XF-9A	SSB	2.4 kHz	5	\$50.60
XF-9B	SSB	2.4 kHz	8	68.60
XF-9B-01	LSB	2.4 kHz	8	91.35
XF-9B-02	USB	2.4 kHz	8	91.35
XF-9B-10	SSB	2.4 kHz	10	119.65
XF-9C	AM	3.75 kHz	8	73.70
XF-9D	AM	5.0 kHz	8	73.70
XF-9E	FM	12.0 kHz	8	73.70
XF-9M	CW	500 Hz	4	51.55
XF-9NB	CW	500 Hz	8	91.35
XF-9P	CW	250 Hz	8	124.95
XF910	IF noise	15 kHz	2	16.35

10.7 MHz CRYSTAL FILTERS

XF107-A	NBFM	12 kHz	8	\$64.10
XF107-B	NBFM	15 kHz	8	64.10
XF107-C	WBFM	30 kHz	8	64.10
XF107-D	WBFM	36 kHz	8	64.10
XF107-E	Pix/Data	40 kHz	8	64.10
XM107-SO4	FM	14 kHz	4	28.70

Write for Data Sheets. Export Inquiries Invited.

Shipping \$3.50

MICROWAVE MODULES VHF & UHF EQUIPMENTS

Use your existing HF or 2M rig on other VHF or UHF bands.

TRANSVERTERS

Models: 10M IF to 6M thru 435 MHz RF	from \$219.95
2M IF to 1269/1296 MHz RF	from \$399.95
Ch2/3 IF to 421/439 MHz ATV RF	from \$349.95

Low Noise RECEIVE CONVERTERS

6M thru 1296 MHz RF, 10M thru 2M IF	from \$64.95
421/439 MHz RF, Ch2/3 ATV IF	from \$74.95
1275 MHz RF, Ch7/8 ATV IF	from \$169.95
also 1691 MHz RF, 137.5 MHz IF	from \$269.95

POWER AMPLIFIERS

2 Meters 25 thru 100 watts	from \$134.95
432 MHz 20 thru 100 watts	from \$174.95
1296 MHz 10 watts	from \$469.95

Write for technical data and price details.

ANTENNAS

(FOB CONCORD, VIA UPS)

144-148 MHz J-SLOTS			
8 over 8 Hor. pol D8/2M	12.3 dBd		\$68.40
8 by 8 Vert. pol D8/2M-vert	12.3 dBd		82.90
8 + 8 Twist 8XY/2M	9.5 dBd		71.40
420-450 MHz MULTIBEAMS			
48 Element 70/MBM48	15.7 dBd		75.75
88 Element 70/MBM88	18.5 dBd		105.50
UHF LOOP YAGIS			
1250-1350 MHz 28 loops 1296-LY	20 dBi		49.75
1650-1750 MHz 28 loops 1691-LY	20 dBi		55.95
Order Loop-Yagi connector extra: Type N			14.95
SMA			6.45

Send 40¢ (2 stamps) for full details of all your VHF & UHF equipment and KVG crystal product requirements.



Local Agents:

Florida: Silvernail Electronics, Inc., Largo, FL	(813) 595-3317
Mid-West: Lee-Tronics, Ltd., Canton, IL	(309) 647-0153
California: P.C. Electronics, Arcadia, CA	(213) 447-4565
N.W. & Alaska: Spectrum West, Seattle, WA	(206) 523-6167



(617) 263-2145
SPECTRUM INTERNATIONAL, INC.
Post Office Box 1084
Concord, MA 01742, U.S.A.

SATELLITE SYSTEM HEADQUARTERS

Don't wait. Get Your TVRO System TODAY!

- Receivers featuring the DEXCEL and Automation Techniques units
- Modulators
- Complete System ready to install from \$2850
- Call today for more information



CHAPARRAL
"Super Feed"
feed horn
\$85.00

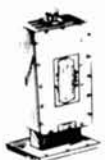

DEXCEL
120 low noise
amplifiers
\$495.00



SATELLITE ANTENNAS
MDS POWER SUPPLIES
\$35.00

1900 to 2500 MHz Microwave Downconverters
Kit \$28.50
Assembled..... \$48.50

ALSO AVAILABLE
Commercial M.D.S. System \$169.95
SLOTTED ARRAY ANTENNA \$28.50

PB RADIO SERVICE

1950 E. PARK ROW • ARLINGTON, TX 76010
CALL ORDER DEPT. TOLL FREE
(800) 433-5169
FOR INFORMATION CALL
(817) 460-7071



**CABLE TV
UHF UP CONVERTER**
\$44.95 . . . (Reg. \$59.95)
(shipping \$3.25)



MICROVERTER VUC-36

Converts Mid and Superband Signals to UHF Channels 43 to 83. Allows all sets to tune without costly separate selector boxes. *Rated #1. Accessory kit available for \$2.00, consisting of matching transformer plus 2 jumper cables.

Call or write for Free Catalog

Other 75 ohm Cable Supplies:

2-way Cable Switch.....	\$4.95
F59A Connectors.....	10/\$2.15
MT6UVFM Back of Set XFMR.....	\$2.39
2-way Splitter.....	\$2.79
4-way Splitter.....	\$4.39
F81 "F" Barrel.....	\$.48
RG-59/U Coax 100% Foil.....	\$.10/ft
Inline Grounding Block.....	\$1.89
Outdoor Matching XFMR.....	\$2.25
Indoor Matching XFMR.....	\$1.25
F61 Chassis Mt. Female.....	\$.48

Parts shipping add 10%, \$2.50 minimum.
COD add \$1.50. Fla. Res. add 4%.

NEMAL ELECTRONICS

5685 SW 80th Street, Miami, FL 33143
Telephone: (305) 661-5534

Iron Powder and Ferrite TOROIDAL CORES

Shielding Beads, Shielded Coil Forms
Ferrite Rods, Pot Cores, Baluns, Etc.

Small Orders Welcome
Free 'Tech-Data' Flyer

AMIDON
Associates Since 1963

12033 Otsego Street, North Hollywood, Calif. 91607



In Germany: Elektronikladen, Wilhelm — Mellies Str. 88, 4930 Detmold 18, West Germany
In Japan: Toyomura Electronics Company, Ltd., 7-9, 2-Chome Sota-Kanda, Chiyoda-Ku, Tokyo, Japan

NEW SURPLUS ELECTRONIC EQUIPMENT CATALOG

New BARGAINS . . . New ITEMS!
FREE UPON REQUEST!
Send today for Your copy of New
FREE CATALOG WS-82 Address: Dept. HR

FAIR RADIO SALES
1016 E. EUREKA • Box 1105 • LIMA, OHIO • 45802

SYNTHESIZED SIGNAL GENERATOR

MADE IN
USA



MODEL
SG1000
\$349.95
plus shipping

- Covers 100 to 185 MHz in 1 kHz steps with thumb-wheel dial
- Accuracy 1 part per 10 million at all frequencies
- Internal FM adjustable from 0 to 100 kHz at a 1 kHz rate
- Spurs and noise at least 60 dB below carrier
- RF output adjustable from 5-500 mV at 50 ohms
- Operates on 12 Vdc @ 1/2 Amp
- Available for immediate delivery • \$349.95 plus shipping
- Add-on Accessories available to extend freq. range, add infinite resolution, voice and sub-audible tones, AM, precision 120 dB calibrated attenuator
- Call for details • Dealers wanted worldwide.

VANGUARD LABS
198-23 Jamaica Ave., Hollis, NY 11423
Phone: (212) 468-2720

The Best Got Better



MODEL 4381 RF POWER ANALYST

This new generation
RF Wattmeter with nine-mode
system versatility reads...

IN STOCK QUICK DELIVERY

AUTHORIZED **RAD** DISTRIBUTOR

Webster
associates

115 BELLARMINE
ROCHESTER, MI 48063

CALL TOLL FREE
800-521-2333
IN MICHIGAN 313 - 375-0420

THE SOLID STATE BEAM.

Introducing the HyGain TH7DX.

Solid state rigs demand a new standard of performance in antenna design.

And HyGain has it: the new TH7DX, The Solid State Beam.

The TH7DX is the first antenna specifically for use with today's advanced, solid-state broadband rigs.

It's small enough to fit on a city residential lot (24 foot boom/20 foot turning radius), and it's all-mode — SSB, Slow Scan, CW, and RTTY.

Most importantly, the TH7DX covers 10, 15, and 20 meters, from band-edge to band-edge, with an SWR below 2:1, so you can load your solid state rig to full rated output without the use of time-consuming tuners.

Forward gain and front-to-back ratio is just as good as the superb TH6DXX — and the patterns hold at the edges of the band. This broadband performance

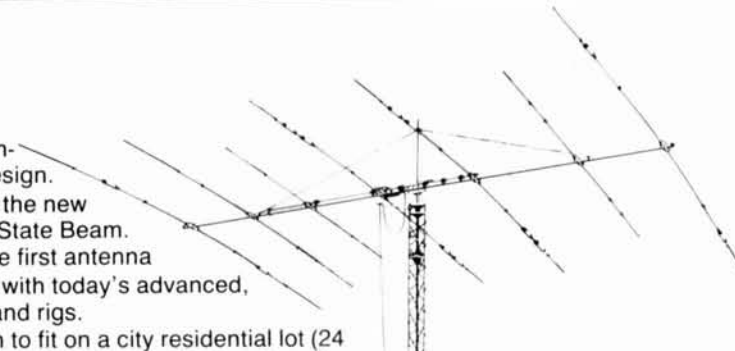

THE MADISON SOLID STATE SPECIAL.

Madison makes it easy to go state-of-the-art. We have special package prices when you buy a solid state rig and the new TH7DX solid state beam to go with it. Call today for a quote on any of these fine rigs and the TH7DX combination.

KWM380	FT707
IC730	FT107
TR7A	FT-One
TS130S	IC720A

is made possible by the new dual-driven element system used on the TH7DX.

If you got a solid state rig, get the Solid State Beam — the new TH7DX from HyGain. And . . . get it from Madison.

Madison not only has the TH7DX in stock, we have it at the lowest prices anywhere. Suggested List \$499.00. Call Madison today for a quote.

We back everything we sell with our personal guarantee.

All Prices FOB Houston and subject to change without notice. Items subject to prior sale.

MADISON

Electronics Supply, Inc.

1508 McKinney • Houston, Texas 77010 • 713-658-0268

Always, Always, Always call for quotes.

Toll Free Nightline.
1-800-231-3057
Monday, Wednesday, Friday
7PM — 10PM CT.

This publication is available in microform.



University Microfilms International

300 North Zeeb Road
Dept. P.R.
Ann Arbor, Mi. 48106
U.S.A.

30-32 Mortimer Street
Dept. P.R.
London WIN 7RA
England

STUDY TAPES

CODE PRACTICE TAPES FROM HRPG — Practice copying Morse Code anytime, anywhere. Whether you're upgrading your present license or just trying to up your code speed, a large assortment allows you to choose exactly the kind of practice you need.

QSO SERIES

each tape \$4.95 2/\$8.95 3/\$12.95

Here's the way to go for those planning to upgrade their present license to General or Extra Class. Both QSO tapes are reproductions of actual on-the-air CW contacts, similar in content to the FCC code exams. Both tapes are recorded at speeds faster than those encountered in the exams. Get the best practice for that all-important code test by mastering these tapes.

- A 90 minute tape of 25 QSOs sent at 15 wpm.
 HR-QSO-1 \$4.95
- A 90 minute tape of 30 QSOs sent at 22.5 wpm.
 HR-QSO-2 \$4.95

PLAIN LANGUAGE TEXT SERIES

Now, there's an opportunity to practice copying code in plain language text, any time of the day. The PLT series is excellent for those who are learning code by the word method. These tapes can also be used to improve sending speed and accuracy by using the provided text and a code practice oscillator to send in time with the tape.

- HR-PLT1 — \$4.95 HR-PLT2 — \$4.95
- | | |
|----------------------------|----------------------------|
| 15 wpm code for 20 minutes | 30 wpm code for 20 minutes |
| 18 wpm code for 20 minutes | 35 wpm code for 15 minutes |
| 22 wpm code for 20 minutes | 40 wpm code for 15 minutes |
| 25 wpm code for 20 minutes | 45 wpm code for 15 minutes |
| | 50 wpm code for 15 minutes |

Please add \$1 for shipping.

Ham Radio's Bookstore
Greenville, NH 03048

antenna geometry for optimum performance

Design considerations
in terms of path distance,
ionospheric height,
and antenna height

If you had your choice of a 10-dB-gain antenna at 40 feet (12 meters) or a 5 dB-gain antenna at 120 feet (37 meters), which would you choose? Presumably, there would be a split decision on such a question. However, the real reply would be that the question does not provide enough data to properly make a sound decision. Antenna gain or antenna height are secondary considerations in antenna design. *The primary objective in an antenna design is to provide maximum signal energy at the desired receiving location.* This is done by providing the most favorable radiation pattern in both the horizontal and vertical planes to match the conditions of a very unstable propagation medium, the ionosphere.

This article discusses the important relationship of the vertical radiation angle of an antenna, height of the ionosphere, and distance between the transmitter and the receiver. As to the opening question, it will simply be stated now that the high-gain antenna on 20 meters would be superior for domestic operations. The 120-foot (37-meter) low-gain antenna would always beat out the higher-gain antenna for maximum distance, world-wide contacts.

ionospheric reflections

High-frequency propagation occurs between the surface of the earth and one or more layers of ionized atmosphere that exhibit sufficient conductivity to re-

flect the radio signals back to earth. One reflection from the ionosphere is called one hop, and the number of hops made by the radio wave before arriving at the receiving location is the number of successive reflections from the ionosphere. These are called multihop transmissions. Single and multihop propagation can occur simultaneously.

Propagation can be further complicated by reflections from more than one conductive layer. Fig. 1 is a simple flat-earth representation of a radio circuit showing reflections from the E, F₁, and F₂ layers of the ionosphere. Single-hop transmissions are shown by the solid lines and two-hop transmissions by a dashed line.

Consider the multiple path signals, both one and two hop, arriving at the receiver due to reflections from the E, F₁, and F₂ layers. Such a situation could exist if there is a broad vertical lobe of radiant energy from the transmitting antenna. The path length of the different signals, as well as the height change with time of the three layers, will cause the signals to arrive at the receiver at different times; that is, the signals will not all be in phase. Such a situation will cause fading of the received signal with loss in quality of the communications circuit.

One may eliminate the E-layer reflection completely by choosing a frequency high enough to penetrate the E layer at any vertical angle of radiation. If the frequency is close enough to the maximum usable frequency (MUF) and F₂ is controlling, then F₁ reflection may be absent, or very small. In such a case, the remaining conflicting wave arrivals would be from a one and two-hop reflection from the F₂ layer. How-

By Henry G. Elwell, Jr., N4UH, Route 2, Box 20G, Cleveland, North Carolina 27013

ever, if it happens that the large angle of incidence at A and C of fig. 1 caused the waves at these points to penetrate the F₂ layer without reflection, only the one-hop F₂ signal would arrive at the receiver at maximum strength with no fading. Elimination of the two-hop path could also occur by restricting the vertical radiation energy to a low angle of fire.

At the other extreme, the operating frequency could be chosen so low that the signal would not penetrate the E layer at all, thus eliminating the F₁ and F₂ reflections. However, there may remain multipath E-layer signals unless the antenna radiation patterns at transmitting and receiving locations provide very low response at the higher angles at which multipath E-layer signals could be propagated.

The known methods of attack on the multipath problem involve these factors:

1. Use a frequency that will cause reflection from one layer only, as nearly as possible.
2. Use a frequency that will require reflection at the lowest angle of incidence possible, such that higher angle radiations will penetrate the layer and not be reflected.
3. Use a directive antenna that will focus the angle of one dominant wave group and discriminate against other multipath signals by relatively low response to all other angles.

On one-hop circuits it might be relatively easy to apply any one or all three of the above principles for reducing multipath circuits. However, on multihop circuits different ionosphere characteristics occur at each point of reflection. Also it is necessary to use a frequency that is a limiting factor at one of the reflection points. Therefore, it is more difficult to adhere to those ideal principles for multihop paths.

is highest gain and height always best?

High antenna gain and high antenna height seem to be the dominant factor in today's selection of antenna systems. That philosophy without further thought to the overall consequences is all right if your goal is to put the strongest signal at the greatest distance at any particular time of the day. Don't be upset, however, if your signal is *less than average* at medium ranges during the daylight hours.

The strength of your transmitted signal received at a distant point, at any time of the day, is a function of your power, antenna gain, antenna height, atmospheric absorption factors, and the height of the ionosphere. Let's eliminate power, antenna gain, and absorption in the following discussion. Power and absorption are independent of the antenna system, and

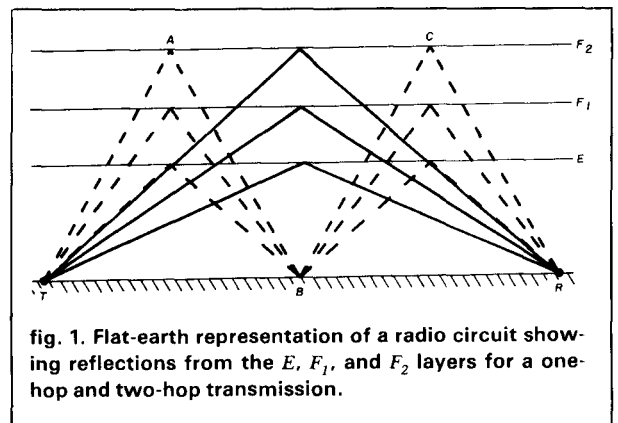

fig. 1. Flat-earth representation of a radio circuit showing reflections from the E, F₁, and F₂ layers for a one-hop and two-hop transmission.

the antenna gain, while important, does little good if the signal does not come down at the desired location.

the propagation-distance formula

The following equation relates the vertical angle of radiation from the antenna and the height of the ionosphere, to the distance between the transmitted signal and the point the signal returns to earth; that is a one-hop occurrence. (The derivation of the equation may be found in the appendix.)

$$D = 222.26 \left\{ \cos^{-1} \left[\frac{\cos \alpha}{(1 + 0.000157 h_i)} \right] - \alpha \right\} \quad (1)$$

where *D* is the surface distance between the transmitting antenna and the first reflected return to earth in kilometers, α is the vertical radiation angle of the antenna in degrees from the horizon, and *h_i* is the height of the ionosphere in kilometers.

If you have a calculator with "cos" and "inverse cos" functions, the equation is easy to solve. However, fig. 2 shows the equation pictorially for various heights of the ionosphere.

The use of the chart is quite simple. Enter the left side of the chart with the known vertical angle of radiation of your antenna. Go horizontally to the right until an intersection with a curve of the desired ionosphere height is met. Then drop down vertically and read the distance scale on the bottom of the chart.

Example. Known: Vertical angle of radiation is 30°. Ionosphere height is 400 km. Distance: 1206 km for one-hop transmission.

height of ionosphere

You say you don't know the height of the ionosphere or the vertical angle of fire of your antenna? OK, let's consider the ionosphere's height, and then we'll spend some time on the vertical radiation problem.

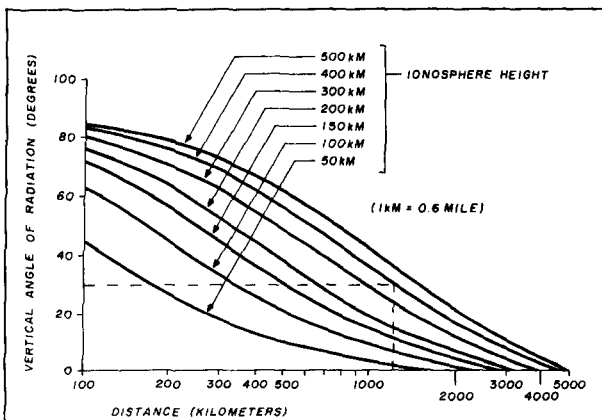

fig. 2. Vertical angle of radiation as a function of distance with ionosphere height as a parameter. An example is given for a vertical radiation angle of 30° and an ionosphere height of 400 km; the distance for a one-hop transmission is 1206 km.

The height of the ionosphere layers varies with latitude, with the hour of the day and the seasons, and with sunspot activity. Over the earth on any particular day, the variations of height are of the order of 2 to 1. Monthly average heights at any one location, however, usually follow a fairly constant pattern.

In some older texts, typical heights were assigned to the layers, but such rough information may be misleading. The Central Radio Propagation Laboratory, when at the National Bureau of Standards, Washington, D.C., used to publish monthly reports on details of various ionosphere heights, but that information has been discontinued. However, we do know the bands of ionosphere heights that will give us sufficient information to make our distance calculations; see table 1 for most intensely ionized regions. These bands of ionosphere heights will be used to show how the distance transmitted for a given vertical radiation angle changes from dawn to noon, for example, as shown in table 1.

vertical radiation angle

The vertical radiation angle of a horizontal antenna is easy to determine. Keep in mind that the vertical radiation of most horizontal antennas is a function only of its height above ground; this includes dipoles,

layer	summer day (km)	winter (km)	night (km)
E	110 - 130	110 - 130	— —
F ₁	280 - 310	210 - 250	275 - 325
F ₂	450 - 480	270 - 320	— —

Yagis, and other horizontally polarized, single-level beams. The number of elements in a Yagi, for example, does not change its vertical radiation angle. The radiation pattern in the vertical plane perpendicular to the wire of the antenna is given by the equation:

$$F(\alpha) = \sin(h \sin \alpha) \quad (2)$$

where α is the vertical angle of radiation from the horizon

h is the height above ground in electrical degrees

The equation is meant for radiation over perfectly conducting ground. However, it is used for pattern work for typical imperfectly conducting grounds such as are encountered in practice.

The value of α for maximum signal at any given height, is when $F(\alpha) = 1$, since a sine function varies from a maximum of 1 to a minimum of 0. The latter factor, 0, means that there will be a null in the vertical radiation at some point.

The workable equation is (see the appendix for derivation):

$$h_{ft} = \frac{\sin^{-1} F(\alpha)}{0.366 f \sin \alpha} \quad (3)$$

where: h_{ft} is the height of the antenna in feet
 α is the vertical angle of radiation from the horizon for the antenna
 f is in MHz

$F(\alpha)$ is 0 or 1, or as we will see later, any number in between such that $\sin^{-1}(1)$ is 90° for first lobe, 270° for second lobe, 450° for third lobe, etc., and $\sin^{-1}(0)$ is 180° for first null, 360° for second null, 540° for third null, and so on.

The solution of this equation with antenna vertical radiations of 90° to 1°, to give corresponding antenna heights for the first lobe at each frequency band, was done on a programmable calculator; doing it manually is a terrible job. Solution of antenna height was preferred over solving for vertical radiation angle because of the limits of 0° to 90° expected from an antenna pattern; antenna height can be from 0 to infinity theoretically.

The graph of the results is shown on fig. 3. That curve is very interesting so let's test it. You have your beam at an 80-foot (24-meter) level and are operating it on the 20-meter band. Enter the curve at the bottom for antenna height of 80 feet (24 meters) and go up vertically until you intersect the 20-meter antenna operating band. At that point go to the left horizontally and determine that the vertical angle of radiation for the antenna is 12.7°. The results for all Amateur bands for an 80-foot (24-meter) tower is shown in table 2.

table 2. Vertical radiation angle for all bands with antenna height of 80 feet (24 meters).

frequency band (MHz)	vertical radiation angle	
	first lobe (degrees)	first null (degrees)
1.90	(note 1)	—
3.80	54.0	(note 2)
7.25	25.0	58.0
10.25	17.5	37.0
14.20	12.7	25.5
18.10	9.8	20.0
21.25	8.2	17.0
24.94	7.0	14.2
28.50	6.2	12.5

(1) 90° is achieved by an antenna 136 feet (41.5 meters) high.
 (2) 90° is achieved by an antenna 129 feet (40 meters) high.

Table 2 should be studied carefully by one-tower owners who like to "Christmas-tree" monobanders for different bands. Such towers usually have the 40-meter beam at the lowest height, then the 20-meter beam is higher, followed by the 15-meter beam, and the 10-meter beam on top. From a propagation standpoint, isn't that the reverse order? I always put the 40-meter beam on top to give it the lowest vertical radiation angle for the available height with the 10-meter beam on the bottom. The 10-meter beam automatically has a reasonable wavelength-height, hence a reasonably low vertical angle of radiation. It's the 40-meter beam that needs the highest location. That of course requires proper consideration for structural integrity.

For you 160-meter enthusiasts, **table 2** shows why a horizontal antenna on that band will be very poor for DX work. Even at 136 feet (41.5 meters) high, it is putting out a vertical radiation angle of 90°. Put your effort and wire into a vertical antenna for DX on 160 meters.

Although an 80-foot (24-meter) high antenna on 80 meters is probably better than the run-of-the-mill on that band, you will still do better with a properly constructed vertical for DX work.

vertical radiation null angle

The second consideration for the antenna height is, "Where are the nulls going to fall?" By making

$F(\alpha) = 0$, such that $\sin^{-1} F(0) = 180^\circ$, the first null can be determined. These values are also shown in **table 2**.

As you can see, **fig. 3**, showing the first lobe for all Amateur bands makes for a pretty busy graph. To show the additional lobes plus nulls would be a disaster. However, all bands for lobes and nulls up to the seventh is easily shown if height above ground is in electrical degrees. **Fig. 4** shows such a curve. To use the curve a calculation is necessary for the height and frequency for which you are interested (see the appendix for proof).

$$h = 0.366 h_{ft} f \quad (4)$$

where: h = height above ground in electrical degrees

h_{ft} = height in feet

f = MHz

Let's say you want to find the lobes and nulls for your 100-foot (30.5-meter) high tribander at 10, 15, and 20 meters. Solution of the equation for h for each band and subsequent use of **fig. 4** would give the results in **table 3**. You might ask the question, "Why bother about the null? There's nothing there anyway, so forget it!" There may be plenty "over there" where your signal is nulled out, and you should at least know about it even though you intend to ignore it. It may be just the knowledge you need to design for a different height or provide for a lower-height antenna to fill in the nulled area.

vertical radiation polar diagrams

Let's look at another representation of maximum (lobes) and nulls: the vertical polar radiation diagrams. See **fig. 5**, which is the 14.2-MHz plot of the 100-foot (30.5-meter) antenna. The same data is being used as in **table 3**. You have seen these in antenna books many times I'm sure. If you are like I am, you may have wondered how they determine their shape. Well, **fig. 5** was calculated and then plotted using the same $F(\alpha) = \sin(h \sin \alpha)$ equation as before.

All you do is select the height of the antenna you want, in feet, change that to electrical degrees, h , for the frequency desired, and solve the equation for dif-

table 3. Nulls/lobes for tribander at 100 feet (30.5 meters).

band (MHz)	height (electrical degrees)	radiation angle (degrees)									
		first		second		third		fourth		fifth	
		lobe	null	lobe	null	lobe	null	lobe	null	lobe	null
14.2	520	10.0	20	31	44	60.6	—	—	—	—	—
21.3	780	6.5	13	20	28	35.0	43	52	68	—	—
28.5	1043	5.0	10	15	20	25.5	31	37	43	50	58

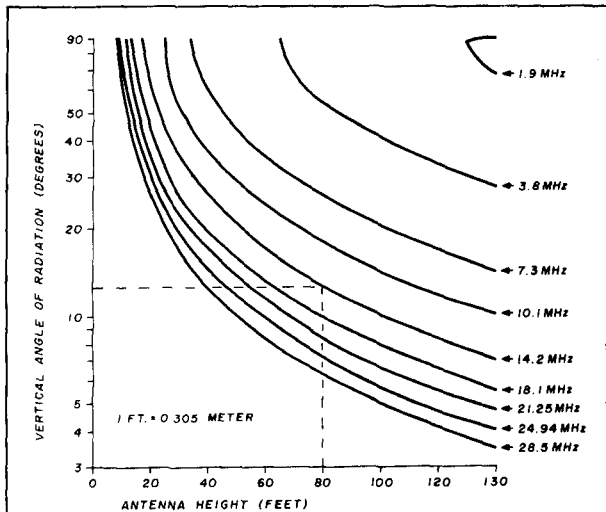

fig. 3. Vertical radiation angle as a function of height for horizontal antennas with frequency as a parameter. Example shows that an antenna height of 80 feet (24 meters) will produce a vertical radiation angle of 12.7° on the 20-meter band.

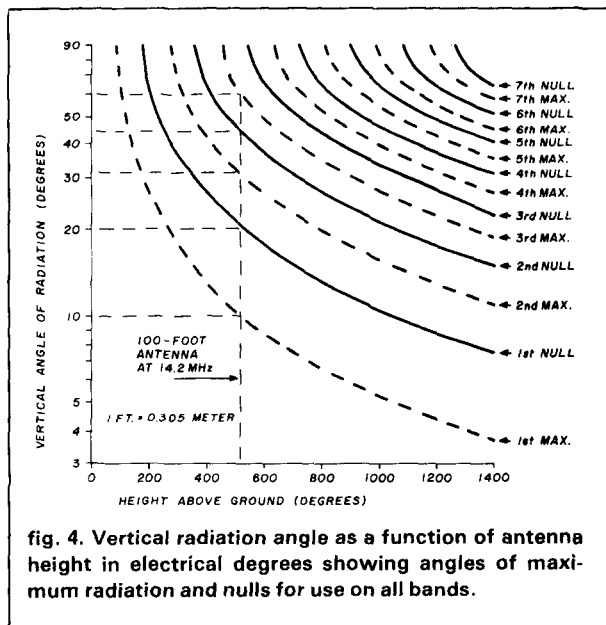

fig. 4. Vertical radiation angle as a function of antenna height in electrical degrees showing angles of maximum radiation and nulls for use on all bands.

ferent values of vertical angle of radiation, α , from 90° to 0°. This will give you the left side of the figure. If you use α equal to 180° to 0°, you get the complete radiation pattern for a dipole. However, one side is a mirror image of the other, and a beam antenna would be attenuated on the back side anyhow; use 90° to 0°.

These calculations are very easy using a programmable calculator when you program it to decrement automatically by 1°, 2°, 5°, or 10° steps from 90° or

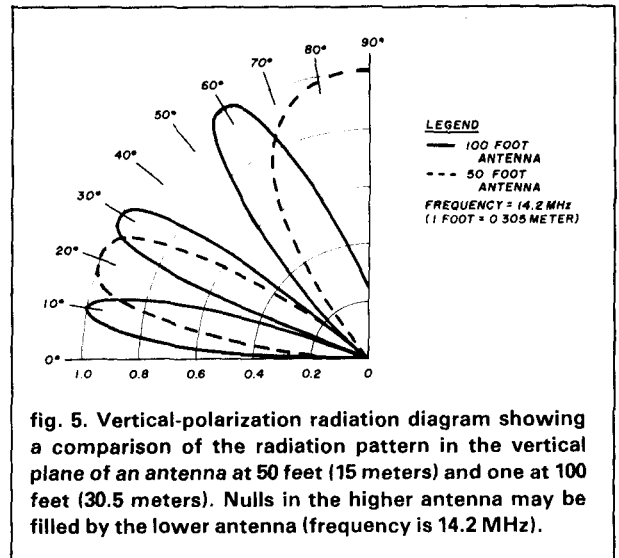

fig. 5. Vertical-polarization radiation diagram showing a comparison of the radiation pattern in the vertical plane of an antenna at 50 feet (15 meters) and one at 100 feet (30.5 meters). Nulls in the higher antenna may be filled by the lower antenna (frequency is 14.2 MHz).

180° as desired; a printer would automatically list the results. For those with computers, a program could be derived to plot the diagram as calculations progress.

Examine fig. 5. It has three lobes and two nulls; the one at 90° is not a full null. Our lobes as shown pictorially there, and tabularly in table 3, are at approximately 10°, 31°, and 60°. An important null is at 20°. Why important? Twenty degrees vertical radiation from fig. 2 with the ionosphere at 400 km, daytime F₂ layer height, is a good 1750 km hop.

From Cleveland, North Carolina, the distance to the heart of Germany is 7023 km, selected as being the center of a densely populated area. It so happens that 7023 km divided by 1750 km (the one-hop distance above) is exactly four hops. From fig. 2, the 10° signal gives a one-hop distance of 2650 km. Divide that number into 7023 and you will see it goes 2.7 hops. You can't have 2.7 hops, so you have to have 3 hops. Three times 2650 km is 7950 km. Therefore, the 10° vertically radiated signal lands almost 1000 km beyond the heart of Germany. However, if we had an antenna giving a 20° vertically radiating signal, it would be stronger than the 10° signal in that area when the ionosphere is at 400 km in height.

Referring back to fig. 3, you can see that a 20° vertical radiation can be obtained by an antenna height of 50 feet (15 meters). Superimpose this vertical radiation pattern on the vertical polar radiation diagram, fig. 5, to get a pictorial representation of how the 20° null is filled in by the 50-foot (15-meter) antenna. All vertical angles from about 6° through 36° are in excess of 80 percent of maximum signal. It is doubtful if you would want to use the 20-meter band for distances which 36° would provide — distances less than 1000 km one-hop.

Carry the analysis further to the 15- and 10-meter

bands with an antenna at 100 feet and one at 50 feet (30.5 and 15 meters); see **figs. 6** and **7**. On 15 meters, the lower antenna fills in the null at 15° , but leaves a null at the 28° vertical angle of radiation. That angle is good for about 1200 km; again a lower frequency would be better.

On 10 meters the same combination appears to be good from about 3° through 17° to give at least an 80 percent of maximum signal over that range. Again, vertical angles greater than 17° on 10 meters probably are not necessary except for sporadic E transmissions. The 100-foot (30.5-meter) antenna by itself would leave some undesirable holes in your vertical radiation pattern.

Those Amateurs with a computer can have a great time moving displays around to show the vertical pattern for a single antenna at different tower heights with a lower antenna to fill in the nulls.

exciting two antennas for greater gain

Of course, once you have two antennas at different heights, your next inclination is to say, "Why don't I excite both of them and get additional gain?" Good idea, but first you should know, "What is that going to give me in the way of vertical angle radiation?" A good question, and its solution is as simple as adding on a second term to the equation we've already been using.

$$F(\alpha) = N[\sin(h_1 \sin \alpha) + \sin(h_2 \sin \alpha)] \quad (5)$$

See **fig. 8** for definitions of h_1 , h_2 , and α ; h_1 and h_2 are in electrical degrees for the frequency being measured. N is a normalizing factor (makes *maximum* = 1) and may vary from one design to another. First run the equation from 90° to the lowest angle. You will see maximum lobe results greater

than 1. To normalize the data, divide all results by the highest lobe results. That makes the highest results equal to 1, with a corresponding decrease in all other numbers. This is called "normalizing the data," and permits an easier comparison of different designs.

The calculator or computer solves the equation for given heights of h_1 and h_2 and varies the vertical angle α from 90° down to zero when programmed properly. Taking 5° steps works out well, but 1° steps may have to be taken at crucial points to determine the *maximum* point of a particular lobe.

Using the 50-foot and 100-foot (15- and 30.5-meter) high antennas at 14.2 MHz fed in phase and solving the $F(\alpha)$ equation produced the plot shown in **fig. 9**. The plots of **fig. 5** are superimposed on **fig. 9** to show the comparison pattern of each single antenna and together. The curve has been normalized (*maximum point* = 1) to compare its vertical angle with respect to the 50-foot and 100-foot (15- and 30.5-meter) curves. It may be seen that the maximum lobe for the combination is at 12° , with three attenuated ones at 38° , 53° , and 90° . A gain of 3 dB is realized in the horizontal plane with the combined antennas.

You may be interested in determining for yourself

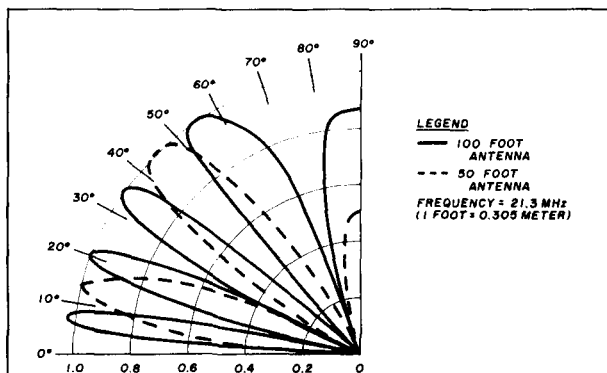

fig. 6. Vertical-polarization radiation diagram showing a comparison of the radiation pattern in the vertical plane of an antenna at 50 feet (15 meters) and one at 100 feet (30.5 meters). Nulls in the higher antenna may be filled in by the lower antenna (frequency is 21.3 MHz).

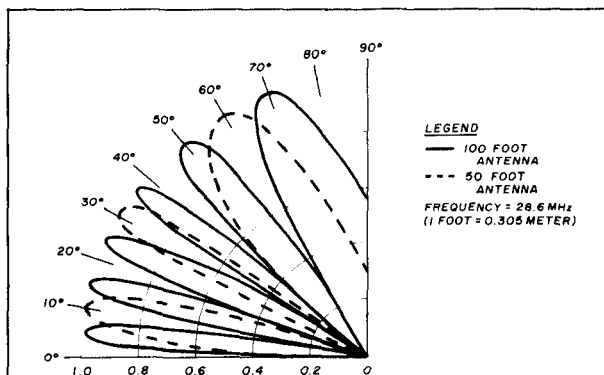

fig. 7. Vertical-polarization radiation diagram showing a comparison of the radiation pattern in the vertical plane of an antenna at 50 feet (15 meters) and one at 100 feet (30.5 meters). Nulls in the higher antenna may be filled in by the lower antenna (frequency is 28.6 MHz).

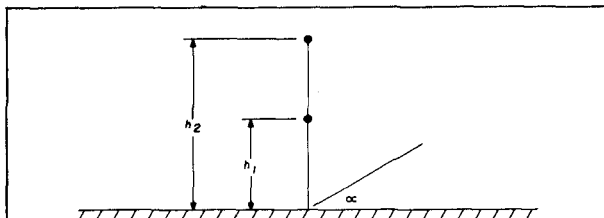

fig. 8. Definition of heights and vertical angle of radiation for two antennas excited in phase.

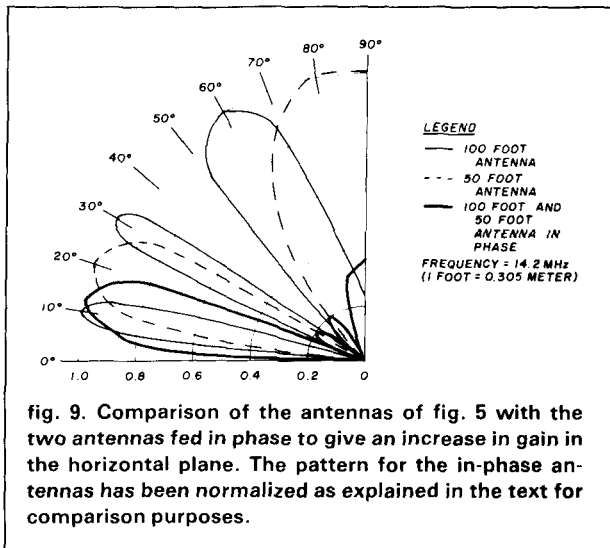

fig. 9. Comparison of the antennas of fig. 5 with the two antennas fed in phase to give an increase in gain in the horizontal plane. The pattern for the in-phase antennas has been normalized as explained in the text for comparison purposes.

what the pattern of half-wave spacing as well as 0.625-wavelength spacing would provide in the way of vertical radiation angles with height. The 0.625-wavelength spacing is the optimum spacing for maximum horizontal gain.

When striving for minimum vertical radiation angle, consider the following. Fig. 2 shows that if the ionosphere were to attain a height of 500 km, the maximum one-hop distance would be 4850 km at 0° vertical angle of radiation. To attain a 0.1° angle of fire would require a horizontal antenna on 28.5 MHz to be at 4,944 feet (1508 meters) high. On 14.2 MHz, a 1° angle of fire would require an antenna at 992 feet (303 meters). So, do not expect to have horizontal antennas with a maximum lobe at 0°.

four-antenna array

As a final exercise for a 100-foot (30.5-meter) high tower, an array of four antennas spaced one-half wavelength apart for 15-meter operation was calculated. This is for the contester who wants to put a fixed array on the side of the tower for Japan, for example. The calculation is done using the same $F(\alpha)$ formula, but having four terms:

$$F(\alpha) = N [\sin(h_1 \sin \alpha) + \sin(h_2 \sin \alpha) + \sin(h_3 \sin \alpha) + \sin(h_4 \sin \alpha)] \quad (6)$$

Fig. 10 shows the vertical signal to be expected. What a beautiful lobe with negligible high angle lobes, thus minimizing interference from short-haul stations. The vertical angle of about 8° produces about a 4-hop trip from North Carolina to Japan. If your 3-element Yagis were used, the horizontal gain would be 14 dB over a dipole. Sure beats a 12-element Yagi on a long boom for simplicity, and remem-

ber all the high-angle lobes you have to put up with using the single beam (refer to fig. 6).

conclusions

This article has attempted to point out the importance of designing an antenna system to put your signal where you want it to go. The variables under your control are the distance to your desired station and the height of your antenna. The variable not under your control is the height of the ionosphere. However, by judicious placement of secondary antennas in the vertical plane, you can effectively use changes in the height of the ionosphere and keep your maximum signal at a given receiver location.

Also, by knowing the vertical angle of radiation of your antenna you can determine proper height for short-haul contest work such as Sweepstakes, as well as long-haul DX contest or general DX work.

Although perhaps an over-simplification of the antenna problem, study of the multi-lobes of high antennas will show how "thin" the lobes are. Thus, changes in the ionosphere height will move the "footprint" of the transmitted signal into and out of your desired reception area more quickly than "fatter" lobes. Also, the multiplicity of lobes from the high antenna may result in multiple path fading problems, as explained earlier. Lower antennas and phased arrays have fatter lobes, hence a broader footprint, and will maintain their signal strength into their directed area for longer periods of time.

Ask yourself before investing in costly towers and antenna systems, "What are my antenna objectives?" Putting the signal into the area you want it to go still seems more important than putting the strongest signal wherever it wants to go. A study of your antenna objectives is not to be taken lightly!

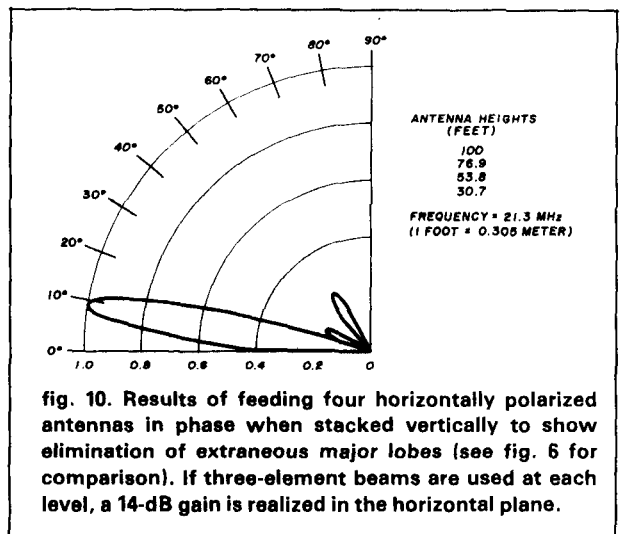

fig. 10. Results of feeding four horizontally polarized antennas in phase when stacked vertically to show elimination of extraneous major lobes (see fig. 6 for comparison). If three-element beams are used at each level, a 14-dB gain is realized in the horizontal plane.

bibliography

- Bogle, H. Glenn, WA9RQY, "Vertical Radiation Patterns of Horizontal Antennas," *ham radio*, May, 1974, page 58.
- Cunningham, John E., *The Complete Broadcast Antenna Handbook*, Tab Books, Blue Ridge Summit, Pennsylvania, pages 180-181.
- Laport, Edmund A., *Radio Antenna Engineering*, Chapter 3, "High Frequency Antenna."
- Lawson, James, L., W2PV, "Yagi Antenna Design: Ground or Earth Effects," *ham radio*, October, 1980, page 29.
- Lawson, James L., W2PV, "Yagi Antenna Design: Stacking," *ham radio*, November, 1980, page 22.
- Oglesby, Ernest, and Cooley, Hollis, *Plane Trigonometry*, Prentiss-Hall, 1933, Chapter V.
- Ionospheric Radio Propagation*, U.S. Department of Commerce, Circular 462, 1948, Chapters 2-7.

appendix

derivation of propagation-distance formula

Fig. A-1 shows a transmitting point at A, a reflection from the ionosphere at point B, and a one-hop return to earth at point D. The virtual height of the ionosphere is h_i , and the average radius of the earth, R_e , is a constant of 6,367.45 km. The intersection of the radius line from the center of the earth to its surface forms a right angle at point A. The vertical angle of radiation, α , is an angle that is added to 90° when determining angle CAB . The distance, AD , along any great circle on the surface of the earth is given by:

$D = R_e \theta$ when θ expressed in radians, or:

$$D = \frac{R_e}{57.296} \theta, \text{ when } \theta \text{ is expressed in degrees.}$$

The problem is to find a relationship of θ with respect to α and h_i and involves the triangle $CABC$. Two sides of that triangle are known: $BC = R_e + h_i$, $CA = R_e$. Angle CAB is known: $\text{angle } CAB = 90^\circ + \alpha = \text{angle } A$.

Knowing two sides and one angle, the other side and angles may be determined from the law of sines.

solution of problem

by law of sines

The law of sines says, given A , a , and b (see fig. A-1):

$$\begin{aligned} \text{Angle } C &= 180^\circ - \text{Angle } A - \text{Angle } B \\ &= \text{Angle } BCA = \frac{\theta}{2} \end{aligned}$$

$$\text{Also, } \frac{b}{\sin B} = \frac{a}{\sin A}, \text{ thus } B = \sin^{-1} \left(\frac{b \sin A}{a} \right)$$

$$\text{and } C = 180^\circ - (90^\circ + \alpha) - \sin^{-1} \left(\frac{b \sin A}{a} \right)$$

Replacing the above with our own symbols:

$$\frac{\theta}{2} = 180^\circ - (90^\circ + \alpha) - \sin^{-1} \left[\frac{R_e \sin(90^\circ + \alpha)}{R_e + h_i} \right]$$

$$\frac{\theta}{2} = 90^\circ - \sin^{-1} \left[\frac{R_e \sin(90^\circ + \alpha)}{R_e + h_i} \right] - \alpha$$

$$\begin{aligned} \text{But } \sin(90^\circ + \alpha) &= \cos \alpha \\ \text{and } 90^\circ - \sin^{-1} \left[\frac{R_e \sin(90^\circ + \alpha)}{R_e + h_i} \right] \end{aligned}$$

$$= \cos^{-1} \left[\frac{R_e \sin(90^\circ + \alpha)}{R_e + h_i} \right]$$

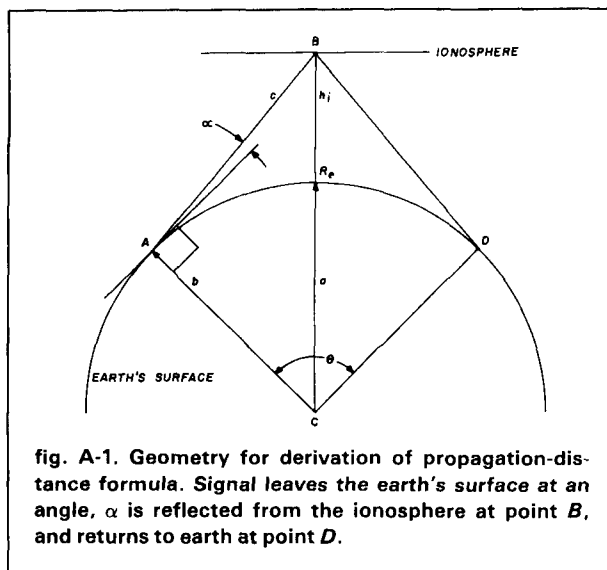

fig. A-1. Geometry for derivation of propagation-distance formula. Signal leaves the earth's surface at an angle, α is reflected from the ionosphere at point B, and returns to earth at point D.

$$\text{Therefore, } \theta = 2 \cos^{-1} \left[\frac{R_e \cos \alpha}{R_e + h_i} \right] - \alpha$$

Knowing θ , we can now solve for D , and cleaning up the \cos^{-1} term, we get:

$$D = \frac{2R_e}{57.296} \left[\cos^{-1} \left(\frac{\cos \alpha}{1 + \frac{h_i}{R_e}} \right) - \alpha \right]$$

but $R_e = 6,367.45 \text{ km}$

Therefore:

$$D = 222.265 \left[\cos^{-1} \left(\frac{\cos \alpha}{1 + .000157h_i} \right) - \alpha \right] \text{ kilometers}$$

height-in-feet equation

We start with the given equation:

$$F(\alpha) = \sin(h \sin \alpha)$$

We wish to change h , which is in electrical degrees to h_{ft} , which is the height of our antenna in feet above the earth's surface.

We know that $1\lambda = 360^\circ$. Therefore the fractional part of a wavelength (any antenna height) is the ratio of actual antenna height in feet to λ in feet times 360° .

$$h = 360^\circ \frac{h_{ft}}{\lambda_{ft}} \text{ degrees, but } \lambda = \frac{984}{f \text{ MHz}} \text{ feet}$$

$$\text{so } h = \frac{360}{984} f_{\text{MHz}} h_{ft} = 0.366 f_{\text{MHz}} h_{ft} \text{ in feet}$$

We can say:

$$\begin{aligned} F(\alpha) &= \sin \left[(0.366 f_{\text{MHz}} h_{ft}) \sin \alpha \right] \\ \sin^{-1} F(\alpha) &= 0.366 f_{\text{MHz}} h_{ft} \sin \alpha \end{aligned}$$

Therefore:

$$h_{ft} = \frac{\sin^{-1} F(\alpha)}{0.366 f_{\text{MHz}} \sin \alpha}$$

ham radio

THE CRYSTAL BALL



ON OR OFF?

From the articles printed in the Crystal Ball it is evident that most of the brethren have their mental machinery running at prewar speeds. Don't they realize that we have entered upon a new era of rockets, A-bombs, robots, and fungicides? Why hack around with these pitiful pseudo-modern ideas for the new Ham Station? Here is a plan for a rig combining simplicity and ease of operation.

First let us examine the fundamental requirements of an ideal amateur station. The primary question confronting the average ham is: does he want his station *on* or does he want it *off*? Reference to the literature will confirm that an "on-off" switch is the most practical solution to this problem. Having established this component as a prerequisite, let us delve into the less-interesting sub-assemblies to be tied into the on-off switch. The best way to cover this is to describe the sequence of operations occurring when this switch is thrown from the "off" to the "on" positions.

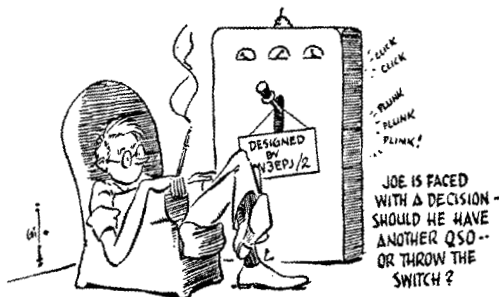

Joe Blow strolls into his shack, turns on the aforementioned switch, lights a cigarette, and starts reading the latest copy of *Esquire*. Rotating beam antennas on all amateur bands start scanning the horizon, feeding in signals to appropriate receivers, which are scanning the bands in frequency, looking for a CQ. Let us suppose that the receiver system on band A finds a CQ first. The audio signal, having passed through the CQ-pass filters operates relays which deenergize the other receivers, switch off the scanning function of antenna A, and automatically point the

beam at the originating transmitter by means of an appropriate servo system. Simultaneously, Joe's own transmitter is automatically tuned to the frequency of the incoming signal, and held in readiness to transmit. As soon as the received signal stops, the transmitter sends out a call automatically prepared on a magnetic wire recorder from the call sent by the other station and including Joe's call.

Whenever the other station breaks in, Joe's transmitter stands by and his receiving system comes into its own. Basically, the signal is fed into three channels, the Log Channel, the QSL Channel, and the Miscellaneous Channel. The Log Channel uses information contained in the signal relating to the signal strength and the time the QSO started, and prints it on the Log Sheet. The QSL Channel, in a similar manner, prints part of the QSL card. The Miscellaneous Channel accumulates the non-essential information passed out by the other station and feeds it into the waste basket. It also performs the very essential function of taking the signal report given, running it through a computer coordinating distance, number of previous QSO's, and blood pressure of Brother Joe in calculating a weighting formula to be applied to the otherwise accurate RST report to be given back to the distant station.

When the victim stands by, Joe's station automatically goes to the transmit position, sends out "Good Morning," "Good Evening," or "Good Afternoon," as determined by a suitably-connected clock, transmits the other fellow's RST report complete with fudge factor, gives the weather as measured by a barometer and thermometer on the roof, states the QTH (not a variable, making this part simpler), adds 73 and signs.

After the other station signs, the Log and QSL machines finish printing their respective cards. When this is complete and the QSL card has been automatically shot out to the nearest mail box, the second-hand air raid siren is energized to distract OM Blow from his *Esquire*. He is then faced with a decision. Should he let things take their course and have another QSO, or should he throw the switch to "off" and delve further into the printed pulchritude?

Carl C. Stotz, W3EPJ/2

ham radio TECHNIQUES

Bill W6SAI

It is difficult to prophesy, especially with respect to the future. — Bob Booth, W3PS (Silent Key).

What will Amateur Radio be like in 2015? Will there be Amateur Radio in thirty-three years from now? Interesting questions, to be sure.

Reprinted from *QST* is a tongue-in-cheek prediction of Amateur Radio's future as seen from 1946. Is our vision of the future as clear as this one, written before the days of transistors, ICs, and computers?

Looking into the cloudy crystal ball, I see Amateur Radio flourishing in 2015 but in a far different form than the hobby of today.

- In 2015, all the computers, communications equipment, and data storage systems you see today will be obsolete museum pieces.

- By 2015, great advances in fiber-optic transmission will make cable communications and most radio communications over fixed, short distances obsolete.

- In 2015, long-distance communications will be exclusively by complex, wideband, high-power satellites and land-based repeaters.

- Radio transmission via the ionosphere, an unreliable medium at best, will be obsolete. VHF satellite repeaters and fiber-optic cables will replace them. *Radio, television, and fm broadcast stations as we know them today will not be in use in 2015; they will not be needed.*

- Home computers, tied into large computer networks around the world, will be commonplace. Information and entertainment will be available on a three-dimensional color screen in most homes.

- It will be possible to call up any of thousands of information channels at will — including direct communications with other computer terminals — worldwide.

why, then, Amateur Radio?

As a consequence of the information explosion and instant communications available in 2015, radio transmission in the medium- and high-frequency spectrum will be obsolete, except for some military purposes (over-the-horizon radar, the Woodpecker, for example), scientific studies, and Amateur Radio communications. All else will be transmitted by other, more reliable, means.

Radio Amateurs will not be restricted to bands in 2015. They will roam freely the entire high-frequency spectrum. And more. Amateurs will work alongside the few users of the radio spectrum over a frequency range of 500 kHz to perhaps 75 MHz. This is how it will be done.

the ham station of 2015

The Amateur station of the future will consist of a broadband transmitter, receiver, and antenna, computer controlled and capable of frequency-agile transmission at any point in the radio spectrum. Let's suppose Our Hero has one of these marvelous devices and wishes to make contact with another Amateur station.

The computer terminal is energized and a propagation display appears on the screen, derived directly from the International Weather Service through the optic-fiber communications line running into the home.

Looking at Europe on the map, Our Hero decides it would be nice to have a chat with a German or French Amateur. He keys his instructions into the computer. Instantly his transmitter is armed with the proper data. It transmits a coded signal (similar to the CQ of olden days) that jumps about in frequency in a sequence selected by the computer that continually sweeps to interrogate the Maximum Usable Frequency (MUF) over the chosen path. Frequency agility is rapid, the signal remaining on any one spot for less than a second. To a casual observer, looking over the range of frequency spotting, *no signal is apparent*. To another observer, however, who has received the coded transmission and keys his equipment up in response to this code, an interference-free signal is received that contains the data needed to transmit a reply in the same coded sequence as that received.

Our Hero, then, has keyed in a frequency agility code, as well as codes that select the region of the earth (or country) to be scanned by his receiving computer. All this information appears on the video screen of his equipment.

The signal is ignored by all stations except those whose computers are programmed to search for the particular code Our Hero is using. Once a code match is established, the second ("reply") station alerts the first ("search") station that it is in lock. The search station may jump about in frequency to dodge interference, but its continually transmitted coding signal forces the reply station to follow it to the exact Hertz!

the QSO

Now that the two stations are completely in lock, the contact can run until the Maximum Usable Frequency falls below the critical cutoff frequency at which signals are lost on the particular path. Continuously listening to each other, the computers instantly shift frequency at will, seeking a clear channel for QRM-free communications.

Our Hero can now choose his mode of communications. Voice? Slow-scan digitized television? Practice CW? Or radio-teletype? Perhaps transmit some music? Why not? He can copy by ear, watch it on a video display, or record it on a form of tape for playback. Or he can do all of these at once.

While the QSO is in progress, giant Woodpecker transmitters used for ionospheric-reflected information gathering roam about the high-frequency spectrum. They, too, by international agreement are frequency-agile, perhaps transmitting only one pulse on a given frequency before moving on, continuously sensing the transmitting frequency for an existing signal before transmitting their powerful pulse.

Intermixed with the Woodpeckers are other forms of pulsed transmissions for military and scientific purposes. And dodging about in this signal mix are the Amateur signals. All services interrogate frequency after frequency until an open spot is found — then *zip!* the pulsed information is sent and retrieved and the transmitter moves on once again.

Listening to this frequency-agile, frequency-hopping, computer controlled mode of transmission on an ordinary receiver would reward the listener with only a random hum, or loud background noise. No intelligence would be apparent. But a locked "reply" station would instantly sift through the myriad signal bits and accept only those bits that its coded memory recognizes.

Armed with propagation information and a "callbook" of the transmis-

sion identification codes used by other Amateurs, Our Hero can quickly program his station to search for a single unique signal, or one group of signals among a family of signals, or any random signal the computer may process in a frequency search. Sometimes it might be fun to speak at random to any station caught during the computer search. And other times a certain station or region may be pinpointed for specific QSOs.

At any given time, tens or hundreds of Amateur stations would be scanning the high-frequency spectrum, either in search or reply mode. If Our Hero desires, each station scanned would pop up on the video screen, showing its individual coded signal (the equivalent of the call letters of half a century earlier). Our Hero can either pick out a contact as the codes pass across the screen or he can instruct his computerized receiver to pick the contact for him. Or he can project himself into the ether with his own coded signal, and wait until another Amateur station locks onto his coded series of pulses. Automatic or manual coded search is available at the touch of a button.

the station library

Once contact is established instant break-in is available, regardless of the communication mode chosen. Bandwidth can be tailored to fit the job at hand. If voice is chosen, the voice is converted into digital signals and reconverted back into speech at the receiving station. Each station will have a memory library tape of thousands of words and the computer will automatically translate one language to another provided the correct coded language information is sent along with the voice. While the Amateur's computerized vocabulary may be limited to perhaps 5,000 words or less, and his sentences may be somewhat constricted by the limited vocabulary of his equipment, a plain language QSO is possible, with each Amateur speaking his own native tongue. The computers will do the rest.

If it is desired, a digital printer will

reproduce the QSL card, or photograph of the station, for instant print-out at the other end. Or a video camera may be cut in for a slow scan picture of station and operator.

At the same time, Our Hero can be in contact with a local VHF repeater (or translator), which can bring in other interested parties to the QSO. These other Amateurs may be on various VHF bands, with simplified equipment that can transmit a signal capable of being translated to a high-frequency, computer-controlled station capable of worldwide communications. Perhaps the high-frequency station is a remote site, located on a commanding hilltop QTH and operated by club members who access the equipment with a private code. Thus the apartment-bound Amateur can achieve worldwide communications through a mini-watt control console that fits on a corner of his desk, or atop his 500-channel, three-dimensional color television receiver and stereo system.

Amateur licensing in 2015

Amateur Radio, like other forms of communications in 2015, is under the control of the Department of Communications, which replaced the antiquated Federal Communications Commission in 1986. The General class license costs ten "new" dollars, the new dollar being equal to one hundred old dollars (which were withdrawn from circulation in 1996 when their real value had depreciated to almost nothing).

The license, good for a lifetime, authorizes the Amateur operator to run up to 5 kW steady state or 50 kW peak power at a repetition rate of less than 10 microseconds. All operating frequencies between 500 kHz and 100 MHz are authorized. Mode of transmission is not specified. The license exam requires a knowledge of the international communications laws (the licensee must pass a simple exam, somewhat akin to the written portion of the driver's license test). There is no technical requirement, as Amateur equipment is too complex to work on

or modify, and all operation and maintenance instructions are provided in a video tape supplied with the equipment and are further encoded in the computer. Since the Morse code is an outmoded form of communications, employed only by eccentrics, no code test is required.

As of 2015, there are over 40 million General class Amateur licenses in the United States, with an equal number scattered over the globe. Even so, with modern communications techniques, interference between Amateurs is at a minimum.

the VHF Amateur license

The highest grade Amateur license in 2015 is the VHF license, which permits operation above 100 MHz and includes satellite operation. A complex technical examination is required for this license. Only 550,000 such licenses exist in the United States.

The VHF Amateur has access to over one hundred high power, repeater style, synchronous satellites, plus the ten active repeaters on the surface of the moon and the three repeaters on Mars. With this galaxy of repeaters at his command, the VHF Amateur can talk to any spot on earth with a simple, ten-thousand channel hand-held VHF transceiver. In addition, he can talk with the hams stationed at the Moon Base (Luna One) and, at times, the hams on the first expedition to the moons of Jupiter and Saturn. He is also licensed for point-to-point earth VHF communications using various exotic modes of propagation.

the genesis of the 2015 ham station

For most of the twentieth century, high frequency communications were linked to limitations in frequency generation. At first, crystal control was used on discrete channels. Later the variable-frequency oscillator provided some limited flexibility over narrow bands. Thus, because of the rigid frequency-generation scheme, a complete legal and technical system was

STEP UP TO TELREX

Professionally Engineered Antenna Systems

Single transmission line "TRI-BAND" ARRAY

MONARCH
TB5EM/4KWP

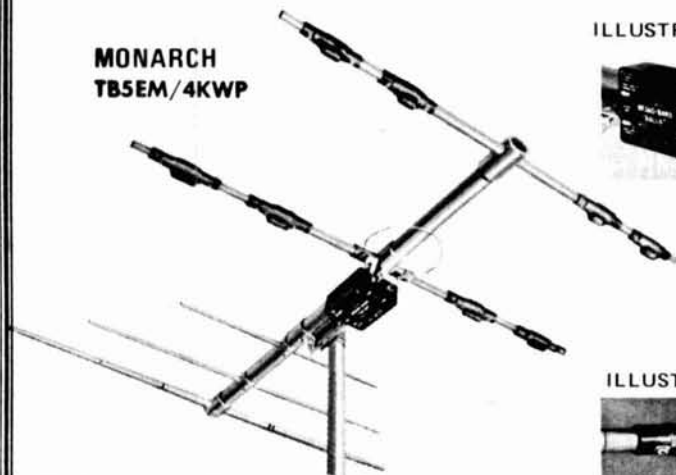

ILLUSTRATION BALUN



ILLUSTRATION TRAP



By the only test that means anything . . . on the air comparison . . . this array continues to outperform all competition . . . and has for two decades. Here's why . . . Telrex uses a unique trap design employing 20 HiQ 7500V ceramic condensers per antenna. Telrex uses 3 optimum-spaced, optimum-tuned reflectors to provide maximum gain and true F/B Tri-band performance.

For technical data and prices on complete Telrex line, write for Catalog PL 7



built up to control spectrum use. This led to the adoption of narrowband antenna systems for the frequencies assigned.

In the late fifties and early sixties, frequency synthesis became a practical reality, making possible high-frequency transmitting/receiving equipment capable of easily and rapidly tuning to any spot in the high-frequency spectrum. This revolutionary technique was inhibited by a regulatory process based upon decades of control built around an outmoded channelized, or "band assignment" concept. With the elimination of the Federal Communications Commission and the establishment of a new regulatory body that had expertise in "adaptive high frequency use," a new world of communications was opened for Radio Amateurs.

The new communications technique obviated frequency bands, heretofore thought sacrosanct. The new philosophy was to use low power equipment to sweep through the entire high-frequency range and

to measure and log all propagation characteristics and interference, without indicating what frequency, or frequencies, would ultimately be used for communicating. Communications with a coded station could be established on any part of the high-frequency spectrum that would support a reliable radio path. Multiple transmission on two or more frequencies at one time, or sequential transmissions on multiple frequencies, was the powerful tool used to achieve reliable communications. Rapid frequency-hopping transmissions, moreover, eliminated the need for Service Assignments, so jealously guarded in the closing days of the late nineties. The old administrative limitations on spectrum occupancy were swept out with a convulsive, international conference, and new regulations were set up to reflect the modern technological revolution.

And thus Amateur Radio grew and prospered in the early years of the twenty-first century!

ham radio

SUNDAY	MON	TUES	WED	THUR	FRI	SATURDAY
<p>WTAW Schedule 1987-1988 EST: 9:00 AM. 7.00 AM. 10.00 AM. 11.00 AM. Club Code Practice MWS 4 P.M. 7 P.M. TRS-S 4 P.M. 10 P.M. 7.00 AM. 9.00 AM. 11.00 AM. TRS-S 7 P.M. 7.00 AM. 9.00 AM. 11.00 AM. TRS-S 7 P.M. 7.00 AM. 9.00 AM. 11.00 AM. TRS-S 7 P.M. Club Code Practice MWS 4 P.M. 7 P.M. TRS-S 4 P.M. 10 P.M. 7.00 AM. 9.00 AM. 11.00 AM. TRS-S 7 P.M. 7.00 AM. 9.00 AM. 11.00 AM. TRS-S 7 P.M. 7.00 AM. 9.00 AM. 11.00 AM. TRS-S 7 P.M. Club Code Practice MWS 4 P.M. 7 P.M. TRS-S 4 P.M. 10 P.M. 7.00 AM. 9.00 AM. 11.00 AM. TRS-S 7 P.M. 7.00 AM. 9.00 AM. 11.00 AM. TRS-S 7 P.M. 7.00 AM. 9.00 AM. 11.00 AM. TRS-S 7 P.M.</p>	<p>GEORGIA QSO PARTY - 13 WEST COAST BULLETIN - 9 PM (10:00 UTC-354C) KCS & 12 16PM - 3</p>	<p>AMSAT East Coast Net 3850 kHz 8PM EST (10:00Z Wednes- day Morning) AMSAT Mid-Continent Net 3850 kHz 8PM CST (0200Z Wednes- day Morning) AMSAT West Coast Net 3850 kHz 7PM PST (0300Z Wednes- day Morning)</p>			<p>HARRIS COUNTY RADIO ASSOCIATION'S ANNUAL FLEA MARKET - Feeding Hills Congregational Church, Routes 57 5111 Leaning Rock Road, Tropic 71431 8-10 AM</p>	<p>ARRL INTERNATIONAL EME COMPETITION - 12 QUANAPOWITT RADIO ASSOCIATION HAMFEST - South Hill Fire Station, corner of Salem and Summer Streets, Lynnfield, Contact K4IMI - 1 SOUTHERN TIER ARC 23RD ANNUAL HAMFEST - Oswego Tread way, Oswego, NY. Contact Craig England - K2ZZ - 1. *YAKIMA ARC ANNUAL HAMFEST - Alhambra Youth Activities Park, Yakima, WA. Contact Dave Planky, N7RBB - 12. BRISTOL JOHNSON CITY & KINGSPORT ARC 2ND TRI-CITIES HAMFEST - Appalachian Fairgrounds, Gray, TN. Contact Tri-Cities Hamfest, POB 3862 CHS, Johnson City, TN 37601 - 12. COUNTY HUNTERS SSB CONTEST - 12</p>
<p>FIFTH ANNUAL P.V.R. FLEA MARKET - George Penny H.S., Eau Claire, WI. Contact: W0JTE - 2 CENTRALIA WIRELESS SOCIETY'S ANNUAL HAMFEST - 1800 E. 1st St., Centralia, WA. Contact: Bud King WB9BGO - 2 AMATEUR RADIO FLEA MARKET - sponsored by the New England Amateur TV Group, Freeport Nat. Orchestra. Pre-register by April 25th to NEAT, POB 406, Boston, MA 02102 - 2 THE-COUNTY RADIO ASSOCIATION'S BEST FLEA MARKET AND CONTEST - 1800 E. 1st St., Centralia, WA. Contact: Bud King, WZCHA, 201-647-3461 - 2 LYNCHBURG ARC ANNUAL HAMFEST - Brookville H.S., Route 460 west of Lynchburg, VA. Details via: POB 4342, Lynchburg, VA 24501 - 2</p>	<p>WIATW QUALIFYING RUN - 10</p>	<p>AMSAT East Coast Net 3850 kHz 8PM EST (10:00Z Wednes- day Morning) AMSAT Mid-Continent Net 3850 kHz 8PM CST (0200Z Wednes- day Morning) AMSAT West Coast Net 3850 kHz 7PM PST (0300Z Wednes- day Morning)</p>	<p>HOLLAND ARC K8DA with other participating sta- tions during Netherlands American Radio Club's 12th Anniversary Celebration on all phone bands and some CW. QSL to HARC, POB 97, Zeland, MI 49464 - 12/8</p>	<p>ROCKLAND COUNTY ARC will operate from Cape Maurice Light house. Operating frequencies: 30 Kc. at bottom of general portion of each band; phone and CW - 15/16 NORTHWEST ARKANSAS ARC 2ND ANNUAL HAMFEST/SWAP MEET - Community Bldg., Rogers on US Hwy. 71. Contact: Mary Webb, KA3HEV - 15 DURHAM FW ASSOCIATION'S ANNUAL DURNHAMFEST - South Square Mall, U.S. 15-501 south, Contact: Durnhamfest, Box 777, Hills- borough, NC 27278 - 15</p>	<p>MICHIGAN QSO PARTY - 15/17 INDIANA QSO PARTY - 15/16 ROCKLAND COUNTY ARC will operate from Cape Maurice Light house. Operating frequencies: 30 Kc. at bottom of general portion of each band; phone and CW - 15/16 NORTHWEST ARKANSAS ARC 2ND ANNUAL HAMFEST/SWAP MEET - Community Bldg., Rogers on US Hwy. 71. Contact: Mary Webb, KA3HEV - 15 DURHAM FW ASSOCIATION'S ANNUAL DURNHAMFEST - South Square Mall, U.S. 15-501 south, Contact: Durnhamfest, Box 777, Hills- borough, NC 27278 - 15</p>	<p>USRR - CQ W Contest - 8/9 ARROWHEAD RADIO AMATEUR CLUB'S ANNUAL SWAPFEST - 3500 N. Main, Arrowhead, MN. Contact: Ed Schilling Party, Duluth, MN, Contact: Jerry Fredrick, WB9JG - 8 OZARKS RADIO CLUBS 4TH ANNUAL SWAPFEST - Circle B Rec Center, Highway 60, Castaldon, WI. Contact: Ozark Radio Club, POB 13, Port Washington, WI 53074 - 8 GREATER FAIRFIELD AREA SPECIAL DOGWOOD FESTIVAL QSO PARTY - Members of the club (WB1TCO) will be on six Amateur Bands to explain the festival. 1300 25th St. C/O 9 AM to 6 PM EST contact: W4UJG, POB 1450, Decatur, GA 30004 - 8 144.95 Single. Contact: N4JUT with SASE for QSL - 8 PUTNAM EMERGENCY AMATEUR RADIO LEAGUE'S FIRST ANNUAL HAMFEST - JFK Elementary School, Fogginton Rd., Brewster, NY. Contact: Frank Konecny, WB2RTP - 8</p>
<p>WEST COAST BULLETIN - 9 PM PDT (8 PM PST, 0400 UTC-354C) KCS & 12 12 PM - 17</p>	<p>AMSAT East Coast Net 3850 kHz 8PM EST (10:00Z Wednes- day Morning) AMSAT Mid-Continent Net 3850 kHz 8PM CST (0200Z Wednes- day Morning) AMSAT West Coast Net 3850 kHz 7PM PST (0300Z Wednes- day Morning)</p>	<p>AMSAT East Coast Net 3850 kHz 8PM EST (10:00Z Wednes- day Morning) AMSAT Mid-Continent Net 3850 kHz 8PM CST (0200Z Wednes- day Morning) AMSAT West Coast Net 3850 kHz 7PM PST (0300Z Wednes- day Morning)</p>	<p>AMSAT East Coast Net 3850 kHz 8PM EST (10:00Z Wednes- day Morning) AMSAT Mid-Continent Net 3850 kHz 8PM CST (0200Z Wednes- day Morning) AMSAT West Coast Net 3850 kHz 7PM PST (0300Z Wednes- day Morning)</p>		<p>WEST COAST BULLETIN - 9 PM PDT (8 PM PST, 0400 UTC-354C) KCS & 12 12 PM - 17</p>	<p>SOUTH SHORE REPEATER ASSOCIATION'S ANNUAL HAM RADIO ELECTRONIC-COMPUTER FLEA MARKET - South Way, Abington, MA 01925 - 2 PORTLAND AMATEUR WIRELESS ASSOCIATION & SOUTHERN MAINE UNIVERSITY RADIO CLUB Annual Flea Market, Gorham, Maine campus. Contact: John Taylor, N1BS - 2 ARRL DELTA DIVISION CONVENTION & 16TH ANNUAL KNOX COUNTY HAMFEST - 800 Lexington Pike, Knoxville, TN. Contact: Raymond Adams, WB4AO, 22/23 CLARK COUNTY ARC 2ND ANNUAL MT. SAINT HELENS QSO PARTY - Frequencies: SSB 3865, 7230, 14290, 21360, 28265. CW: 3705, 7105, 21105, 28105. VHF: Various Vancouver and Portland area repeaters. For QSL send to Award Manager, W7AIA, POB 1424, Van- couver, WA 98278 - 22/23 ANDERSON, HARTWELL & TOCCO ARC ANNUAL HAMFEST - 355 E. 15th St., Sandusky, NY 14851. Contact: Dave Patin, WB4ZLG - 22/23 SMITHS FALLS ARC Special events station, C23SER on all HF bands and 2 meters. Send SASE to: POB 215 Smiths Falls, ON, Canada K0A 4 1R0. QSL - 22 ROCKY MOUNTAIN QSO PARTY - 22/23</p>
<p>BISHOP ARC will operate the KABAMT from the truck capable of the mobile phone. Contact: Steve K6KAO, POB 3625, 7240, 14296, 146, 34, 34. For QSL send SASE to Bishop ARC, POB 1024, Bishop, CA 95514 - 31</p>					<p>WESBADEN ARC 4TH ANNUAL FLEA MARKET TO LUCHTEN- STEIN - Ghelena Dalwa-HBO C/O: Pieter-Jan RITte, at the Netherlands Radio Club's 12th Anniversary Celebration will be attempted at 1725 and 2100 MHz between 1900 and 2100 EST. For more information contact: Y0A 9109 4033 APO New York 9109 for QSL. 21/20 FRESCO ARC 40TH ANNUAL HAMFEST - 99 Avenida del Comercio, Fresno, CA 93702 Contact: Fresno ARC, POB 383, Fresno, CA 93712 21/23</p>	<p>SMITHS FALLS ARC Special events station, C23SER on all HF bands and 2 meters. Send SASE to: POB 215 Smiths Falls, ON, Canada K0A 4 1R0. QSL - 22 ROCKY MOUNTAIN QSO PARTY - 22/23</p>
<p>WEST COAST BULLETIN - 9 PM PDT (8 PM PST, 0400 UTC-354C) KCS & 12 12 PM - 17</p>						<p>SOUTH SHORE REPEATER ASSOCIATION'S ANNUAL HAM RADIO ELECTRONIC-COMPUTER FLEA MARKET - South Way, Abington, MA 01925 - 2 PORTLAND AMATEUR WIRELESS ASSOCIATION & SOUTHERN MAINE UNIVERSITY RADIO CLUB Annual Flea Market, Gorham, Maine campus. Contact: John Taylor, N1BS - 2 ARRL DELTA DIVISION CONVENTION & 16TH ANNUAL KNOX COUNTY HAMFEST - 800 Lexington Pike, Knoxville, TN. Contact: Raymond Adams, WB4AO, 22/23 CLARK COUNTY ARC 2ND ANNUAL MT. SAINT HELENS QSO PARTY - Frequencies: SSB 3865, 7230, 14290, 21360, 28265. CW: 3705, 7105, 21105, 28105. VHF: Various Vancouver and Portland area repeaters. For QSL send to Award Manager, W7AIA, POB 1424, Van- couver, WA 98278 - 22/23 ANDERSON, HARTWELL & TOCCO ARC ANNUAL HAMFEST - 355 E. 15th St., Sandusky, NY 14851. Contact: Dave Patin, WB4ZLG - 22/23 SMITHS FALLS ARC Special events station, C23SER on all HF bands and 2 meters. Send SASE to: POB 215 Smiths Falls, ON, Canada K0A 4 1R0. QSL - 22 ROCKY MOUNTAIN QSO PARTY - 22/23</p>

*See Coming Events

MORE PERFORMANCE FOR YOUR DOLLAR! COMPETITORS KNOW ABOUT THE ISOPOLE™ DO YOU? STUDY THE FACTS ...

The IsoPole antenna is building a strong reputation for quality in design and superior performance. Innovative IsoPole conical sleeve decouplers (pat. pend.) offer many new design advantages.

All IsoPole antennas yield the **maximum gain attainable** for their respective lengths and a zero degree angle of radiation. Exceptional decoupling results in simple tuning and a significant reduction in TVI potential. Cones offer greater efficiency over obsolete radials which radiate in the horizontal plane and present an unsightly bird's roost with an inevitable "fallout zone" below. The IsoPoles have the broadest frequency coverage of any comparable VHF base station antenna. This means no loss of power output from one end of the band to the other when used with SWR protected solid state transceivers.

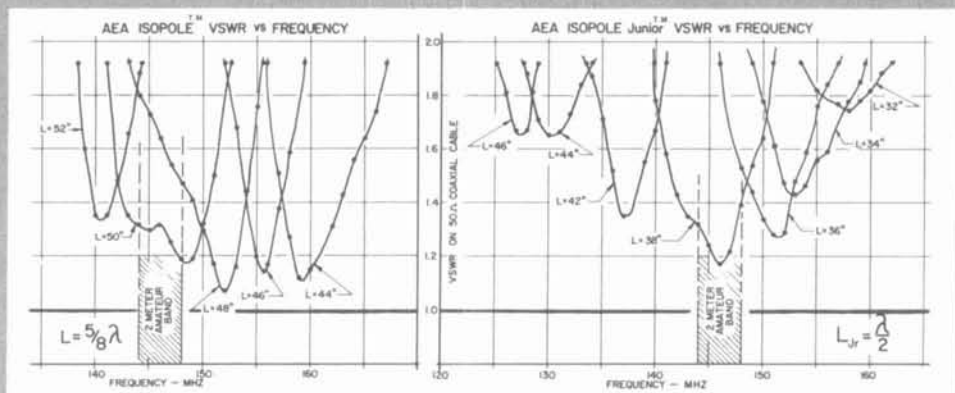

Outstanding mechanical design makes the IsoPole the only logical choice for a VHF base station antenna. A standard Amphenol 50 Ohm SO-239 connector is recessed within the base sleeve (fully weather protected). With the IsoPole, you will not experience aggravating deviation in SWR with changes in weather. The impedance matching network is weather sealed and designed for maximum legal power. All IsoPole antennas are D.C. grounded. The insulating material offers superb strength and dielectric properties, plus excellent long-term ultra-violet resistance. All mounting hardware is stainless steel. The decoupling cones and radiating elements are made of corrosion resistant aluminum alloys. The aerodynamic cones are the only appreciable wind load and are attached directly to the support (a standard TV mast which is **not supplied**).

IsoPole antennas have also become the new standard for repeater applications. They all offer low angle of radiation, low maintenance, easy installation, and low cost with gain comparable to units costing several times as much. Some repeater installations have even eliminated the expense of a duplexer by using two IsoPole antennas separated vertically by about twenty feet. This is possible because of the superior decoupling offered by the IsoPole antennas.

The IsoPole antenna is now available in a 440 MHz version which is fully assembled and tuned.

Our competitors have reacted to the IsoPole, maybe you should too! Order your IsoPole or IsoPole Jr. today from your favorite Amateur Radio Distributor.

ISOPOLE 144
ISOPOLE 220
MAST NOT
SUPPLIED

AEA Brings you the
Breakthrough!

PRICES AND SPECIFICATIONS SUBJECT TO CHANGE WITHOUT NOTICE OR OBLIGATION.



ISOPOLE 440

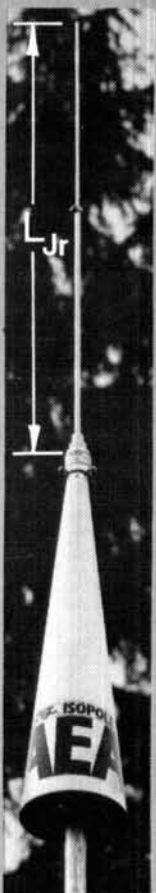

ISOPOLE
144JR
ISOPOLE
220JR
MAST NOT
SUPPLIED



THE CONTESTER™

Computerized
Morse Code Keyer

WITH THE NEW AEA MODEL
CK-2, YOU TOO CAN HAVE THE
WINNER'S EDGE

Operates from external 12VDC @ 200 ma.

NEW ... \$99.95

The model CK-2 "CONTESTER" is part of the latest generation of famous AEA computerized electronic keyers. Like many of our other innovative electronic products, the Contester™ keyer utilizes a custom AEA microcomputer with proprietary copy-written software. The CK-2 retains virtually all the remarkable features of the CK-1 predecessor such as an automatic serial number generator, large soft-partitioned memory with editing capabilities, etc. In addition, we have added CMOS memory with internal battery keep-alive provisions, automatic repeat mode and a **lower price!** See it now so you too can appreciate the fine quality of design and craftsmanship that goes into all AEA products.

ACCESSORIES:

AC-2 350 Ma 12 VDC Wall Adaptor \$9.95
DC-2 Mating Rechargeable 8 hour Battery Pack and Charger \$39.95

PRICES AND SPECIFICATIONS SUBJECT TO CHANGE WITHOUT NOTICE

call or visit:

TOLL FREE 800-336-8473
TUE-SAT 10AM-4PM EST

AEA
Brings you the
Breakthrough!

EEB

516 Mill Street, N.W.
Vienna, Va. 22180
(703) 938-3350



I WANT YOU TO GET
YOUR LICENSE

**TUNE IN THE WORLD
WITH HAM RADIO**

by ARRL Staff

This package contains **THE** goodies needed by the beginner to get started in Amateur Radio. Assuming that you have no prior knowledge of radio, the reader is taught how to pass the Novice exam, both code and theory, and how to set up a station. Unique code study method makes learning the Morse code easy as 1-2-3. And it's full of illustrations to help clarify difficult technical points. 160 pages. ©1981. 3rd edition.

AR-HR **\$8.50**
plus \$1 shipping

INSTRUCTORS —
Call about ISP Program
(603) 878-1441

**HAM RADIO'S
BOOKSTORE**
Greenville, NH 03048

Take your favorite H.T. out for a drive tonight.

VISA or MASTERCARD for
same day shipment.

For \$69.95 you get the most efficient,
dependable, fully guaranteed 35W 2 meter
amp kit for your handy talkie money can buy.

Now you can save your batteries by operating
your H.T. on low power and still get out like a
mobile rig. The model 335A produces 35 watts
out with an input of 3 watts, and 15 watts out with
only 1 watt in. Compatible with IC-2AT, TR-2400,
Yaesu, Wilson & Tempo! Other 2 meter models are avail-
able with outputs of 25W and 75W, in addition to a 100W
amplifier kit for 430MHZ.



Communication Concepts Inc. 2648 N. Aragon Ave., Dayton, OH 45420
(513) 296-1411

HERE'S A GIFT IDEA!

How about an attractive **BASEBALL** style cap that has name and
call on it. It's the perfect way to keep eyes shaded during Field
Day, it gives a jaunty air when worn at Hamfests and it is a great
help for friends who have never met to spot
names and calls for easy recognition.
Great for birthdays, anniversaries, special days,
whatever occasion you want it to be.



Hats come in the following colors:
GOLD, BLUE, RED, KELLY GREEN.
Please send call and name
(max 6 letters per line).
\$5.00 plus \$1.00 for shipping.

HAM RADIO'S BOOKSTORE
GREENVILLE, N. H. 03084-0489

SMITHE

ALUMINUM
6061-T6 TUBING VIA UPS!
6' lengths

Diameter	.035 wall	.058 wall
1/4"	\$2.65	\$2.75
3/8	2.75	3.45
1/2	3.30	4.50
5/8	4.15	5.30
3/4	4.25	5.80
7/8	4.80	6.50
1	5.10	7.40
1 1/8"		8.25
1 1/4		9.10
1 3/8		10.40
1 1/2		11.55
1 5/8		12.50
1 3/4		13.25
1 7/8		13.75
2		14.95

Shipping: \$3.50 per order in U.S.
COMPLETE CATALOG - 50 CENTS

SMITHE ALUMINUM P.O. BOX 273
BONIFAY FL 32425 PHONE (904) 547-4411

New Automatic Antenna Tuner Auto-Track Model AT 2500



Options Available at Extra Cost



Shown with Rack Mount



Shown with Front Panel Handles

Check these state-of-the-art specifications

- Power Capability: 2500 W PEP.
- Frequency Range: Continuous 3.0 to 30 MHz (Including WARC Bands).
- Impedance Matching: 10 ohms to 300 ohms to 50 ohms resistive.
- Direct Reading SWR Meter: 1:1 to infinity.
- Direct Reading Power Meter: Two meter scales from 0 W to 250 W and 0 W to 2500 W; front panel switch selects FWD or Reflected Power (*Illuminated panel meters*).
- Power meter displays RMS with continuous carrier and automatically displays PEAK when driven with SSB signal.
- Average "Automatic" tune-up time: 15 seconds or less.
- Tune-up time not affected by power level; can be as low as 1 W (5-10 W preferred).
- A unique "Linear Disable" circuit automatically switches companion linear amplifier to standby within milliseconds whenever SWR exceeds the threshold preset on front panel, thus protecting the linear from excessive SWR.
- Toroidal bridge coupler provided in separate enclosure, permitting it to be installed directly at the output of the transmitter for meaningful SWR measurements.
- Power requirements are 115/230 VAC 50-60 Hz, 10 W operating / 5 W standby; or 13.5 VDC, 1 A operating / .5 A standby.
- Antenna tuner packaged in cabinet 17"W x 5 1/4"H x 14"D (Front panel handles or rack mount optional).

Specifications subject to change without notice.

Write for literature.



J. W. Miller Division

BELL INDUSTRIES

19070 REYES AVE. ■ P.O. BOX 5825
COMPTON, CALIFORNIA 90224
PHONE: (213) 537-5200



Ham Radio's guide to help you find your local

California

C & A ELECTRONIC ENTERPRISES
22010 WILMINGTON AVE.
SUITE 105
CARSON, CA 90745
213-834-5868
Not The Biggest, But The Best —
Since 1962.

JUN'S ELECTRONICS
3919 SEPULVEDA BLVD.
CULVER CITY, CA 90230
213-390-8003 Trades
714-463-1886 San Diego
The Home of the One Year Warranty
— Parts at Cost — Full Service.

SHAVER RADIO, INC.
1378 S. BASCOM AVENUE
SAN JOSE, CA 95128
408-998-1103
Azden, Icom, Kenwood, Tempo,
Ten-Tec, Yaesu and many more.

Connecticut

HATRY ELECTRONICS
500 LEDYARD ST. (SOUTH)
HARTFORD, CT 06114
203-527-1881
Call today. Friendly one-stop shop-
ping at prices you can afford.

Delaware

DELAWARE AMATEUR SUPPLY
71 MEADOW ROAD
NEW CASTLE, DE 19720
302-328-7728
Icom, Ten-Tec, Swan, DenTron,
Tempo, Yaesu, Azden, and more.
One mile off I-95, no sales tax.

Florida

AMATEUR ELECTRONIC SUPPLY
1898 DREW STREET
CLEARWATER, FL 33515
813-461-HAMS
Clearwater Branch
West Coast's only full service
Amateur Radio Store.

AMATEUR ELECTRONIC SUPPLY
621 COMMONWEALTH AVE.
ORLANDO, FL 32803
305-894-3238
Fla. Wats: 1 (800) 432-9424
Outside Fla: 1 (800) 327-1917

AMATEUR RADIO CENTER, INC.
2805 N.E. 2ND AVENUE
MIAMI, FL 33137
305-573-8383
The place for great dependable
names in Ham Radio.

RAY'S AMATEUR RADIO
1590 US HIGHWAY 19 SO.
CLEARWATER, FL 33516
813-535-1416
Your complete Amateur Radio and
Computer Store.

Indiana

THE HAM SHACK
808 NORTH MAIN STREET
EVANSVILLE, IN 47710
812-422-0231
Discount prices on Ten-Tec, Cubic,
Hy-Gain, MFJ, Azden, Kantronics,
Santec and others.

Kansas

ASSOCIATED RADIO
8012 CONSER, P. O. BOX 4327
OVERLAND PARK, KS 66204
913-381-5900
America's No. 1 Real Amateur Radio
Store. Trade — Sell — Buy.

Maryland

THE COMM CENTER, INC.
LAUREL PLAZA, RT. 198
LAUREL, MD 20810
800-638-4486
Kenwood, Drake, Icom, Ten-Tec,
Tempo, DenTron, Swan & Apple
Computers.

Massachusetts

TEL-COM, INC.
675 GREAT ROAD, RTE. 119
LITTLETON, MA 01460
617-486-3040
617-486-3400 (this is new)
The Ham Store of New England
You Can Rely On.

Minnesota

MIDWEST AMATEUR RADIO SUPPLY
3452 FREMONT AVE. NO.
MINNEAPOLIS, MN 55412
612-521-4662
It's service after the sale that counts.

Nevada

AMATEUR ELECTRONIC SUPPLY
1072 N. RANCHO DRIVE
LAS VEGAS, NV 89106
702-647-3114
Pete, WA8PZA & Squeak, AD7K
Outside Nev: 1 (800) 634-6227

JUN'S ELECTRONICS
460 E. PLUMB LANE — 107
RENO, NV 89502
702-827-5732
Outside Nev: 1 (800) 648-3962
Icom — Yaesu Dealer

New Hampshire

TUFTS ELECTRONICS
61 LOWELL ROAD
HUDSON, NH 03051
603-883-5005
New England's friendliest ham store.

New Jersey

RADIOS UNLIMITED
P. O. BOX 347
1760 EASTON AVENUE
SOMERSET, NJ 08873
201-469-4599
New Jersey's only factory authorized
Yaesu and Icom distributor. New and
used equipment. Full service shop.

Dealers: *YOU SHOULD BE HERE TOO!*
Contact Ham Radio now for complete details.

Amateur Radio Dealer

ROUTE ELECTRONICS 46
225 ROUTE 46 WEST
TOTOWA, NJ 07512
201-256-8555

ROUTE ELECTRONICS 17
777 ROUTE 17 SOUTH
PARAMUS, NJ 07625
201-444-8717
Drake, Cubic, DenTron, Hy-Gain,
Cushcraft, Hustler, Larsen, MFJ,
Butternut, Fluke & Beckman
Instruments, etc.

New York

BARRY ELECTRONICS
512 BROADWAY
NEW YORK, NY 10012
212-925-7000
New York City's Largest Full Service
Ham and Commercial Radio Store.

GRAND CENTRAL RADIO
124 EAST 44 STREET
NEW YORK, NY 10017
212-599-2630
Drake, Kenwood, Yaesu, Atlas,
Ten-Tec, Midland, DenTron, Hy-Gain,
Mosley in stock.

HARRISON RADIO CORP.
20 SMITH STREET
FARMINGDALE, NY 11735
516-293-7990
"Ham Headquarters USA" since
1925. Call toll free 800-645-9187.

RADIO WORLD
ONEIDA COUNTY AIRPORT
TERMINAL BLDG.
ORISKANY, NY 13424
TOLL FREE 1 (800) 448-9338
NY Res. 1 (315) 337-0203
Authorized Dealer — ALL major
Amateur Brands.
We service *everything* we sell!
Warren K2IXN or Bob WA2MSH.

Ohio

AMATEUR ELECTRONIC SUPPLY
28940 EUCLID AVE.
WICKLIFFE, OH (CLEVELAND AREA)
44092
216-585-7388
Ohio Wats: 1 (800) 362-0290
Outside Ohio: 1 (800) 321-3594

UNIVERSAL AMATEUR RADIO, INC.
1280 AIDA DRIVE
REYNOLDSBURG (COLUMBUS), OH
43068
614-866-4267
Featuring Kenwood and all other
Ham gear. Authorized sales and ser-
vice. Shortwave headquarters. Near
I-270 and airport.

Oklahoma

DERRICK ELECTRONICS, INC.
714 W. KENOSHA — P.O. BOX A
BROKEN ARROW, OK 74012
Your *Discount* Ham equipment dealer
in Broken Arrow, Oklahoma
1-800-331-3688 or
1-918-251-9923

Pennsylvania

**HAMTRONICS,
DIV. OF TREVISE ELECTRONICS**
4033 BROWNSVILLE ROAD
TREVISE, PA 19047
215-357-1400
Same Location for 30 Years.

LaRUE ELECTRONICS
1112 GRANDVIEW STREET
SCRANTON, PENNSYLVANIA 18509
717-343-2124
Icom, Bird, Cushcraft, Beckman,
Fluke, Larsen, Hustler, Astron,
Antenna Specialists, W2AU/W2VS,
AEA, B&W, CDE, Sony, Vibroplex.

Virginia

ELECTRONIC EQUIPMENT BANK
516 MILL STREET, N.E.
VIENNA, VA 22180
703-938-3350
Metropolitan D.C.'s One Stop
Amateur Store. Largest Warehousing
of Surplus Electronics.

Wisconsin

AMATEUR ELECTRONIC SUPPLY
4828 W. FOND DU LAC AVE.
MILWAUKEE, WI 53216
414-442-4200
Wisc. Wats: 1 (800) 242-5195
Outside Wisc: 1 (800) 558-0411

**SAY
YOU SAW
IT IN
ham radio!**

BASE RINGO RANGER II

7dB GAIN
HIGHEST GAIN
2 METER OMNI
OUTPERFORMS
CONE AND
DOUBLE ZEPP
WORK MORE STATIONS
ELIMINATE NOISE
LIGHTNING PROTECTED
ACCESS MORE REPEATERS
ASSEMBLE EASILY
INSTALL QUICKLY
A COMPLETE ANTENNA
ALL PARTS INCLUDED
600,000 HAPPY USERS
BECOME ONE TODAY
ARX-2B 134-164MHz
ARX-220B 220-225MHz
ARX-450B 435-450MHz

Cushcraft
CORPORATION
**2 METER
RANGERS**

MOBILE RANGERS

MORE RANGE
3 dB GAIN
5/8" A STAINLESS WHIP
GRIP TIGHT 90LB
MAGNET
CHROME PLATED BASE
NEAT APPEARANCE
THUMB LOCK ADJUSTMENT
NO WHIP CUTTING
LOW PRICE
MAGNETIC MOUNTS
AMS-147 146-148 MHz
AMS-220 220-225 MHz
TRUNK LIP MOUNTS
ATS-147 146-148 MHz
ATS-220 220-225 MHz

MOBILE

BUY FROM YOUR DEALER

ege, inc.

ORDER TOLL FREE
1-800-336-4799

14415 Jefferson Davis Hwy. Woodbridge, Virginia 22191

Spring Picks For Your Bookshelf



1982 U.S. RADIO AMATEUR CALLBOOK

No Amateur station is complete without the very latest Callbook! The 1982 U.S. Callbook features over 390,000 up-to-date names and addresses right where you want them — at your finger tips. Also contains many helpful operating and station aids. ©1981. Softbound.

CB-US \$18.95 + \$3.05 shipping (U.S.A.) = \$22.00

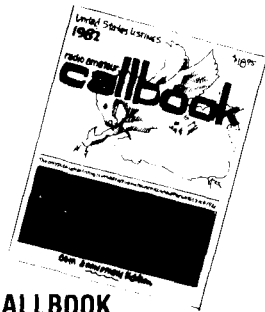

1982 FOREIGN CALLBOOK

If DX is your "thing" then you need a copy of the 1982 Foreign Callbook. Getting a QSL card can be quite a chore without proper names and addresses. Make sure you don't miss out. ©1981. Softbound.

CB-F \$17.95 + \$3.05 shipping (U.S.A.) = \$21.00

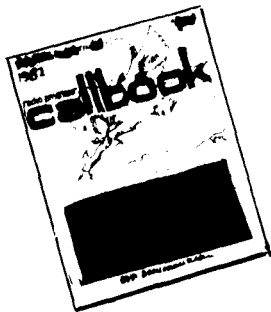

Get 'em both! You save money too!

CB-USF Only \$39.95

RADIO HANDBOOK by Bill Orr, W6SAI 22ND EDITION

The Radio Handbook has been an electronic best seller for over 45 years! This brand new edition reflects all of the latest state-of-the-art advances in a comprehensive, single source reference book. An invaluable aid for Hams, technicians, and engineers alike. Also chock-full of projects and other ideas that are of interest to all levels of electronics expertise. 1136 pages. ©1981. 22nd edition.

21874 Hardbound \$34.95

BAND-AIDS by James E. Dersch, KB7FT

This revised edition of Band-Aids contains a collection of the most often used operating aids, charts and tables that every Ham needs. Not only does it cover the fundamentals of operating, but it also contains operating aids for CW Communications, WWV and WWHH broadcasting schedules, DXCC check sheet and international prefixes, plus many other features. A handy reference data section includes conversion tables, metric data and abbreviations. ©1981. 156 pages.

CC-BA Spiralbound \$9.95

1982 ARRL RADIO AMATEUR'S HANDBOOK

Internationally recognized, universally consulted. It's the all purpose volume for radio. Jam packed with information, drawings, and illustrations that are useful to the Amateur and professional alike. Get your copy today. ©1981.

AR-HB82 Softbound \$10.00
 AR-BB82 Hardbound \$15.75



HOW TO BUILD HIDDEN, LIMITED SPACE ANTENNAS THAT WORK Brand New

by R. J. Traister

Space problems limiting your signal? It doesn't have to be that way. How-to book complete with plenty of projects on how to put out that big signal. Projects include suspended multi-band vertical, window antenna, attic dipole, 20m indoor antenna, two meter coaxial and much more. Softbound 308 pages. ©1981.

T-1254 \$9.95

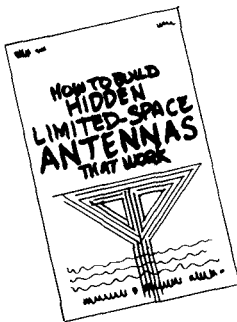

PACKET RADIO by Robert Rouleau, VE2PY and Ian Hodgson, VE2BEN

Packet Radio could be one of the most important technological developments in Amateur Radio this decade. Can you imagine getting your newspaper or paying bills through a computer terminal linked by radio with other computers? It's happening. **now.** And you should make yourself aware of all the amazing things packet radio can do for you. This comprehensive sourcebook explains all the principles of packet radio in an easy-to-understand, non-technical language. You'll learn all about modulation, bandwidths, polling, random access, data rates and more. Plus there is an overview of how the computer is integrated into the packet concept with discussions on the software and peripheral equipment that is used. Finally, the authors give you a detailed description of the packet system in use in the Montreal, Quebec area. ©1981. 1st Edition, 304 pages.

T-1345 Softbound \$11.95



Send today for a free book catalog. Chock-full of interesting books on all aspects of Radio Communications.

Can't wait? (603)
CALL TODAY 878-1441

For books other than US and Foreign Callbooks, please add \$2.50 to cover shipping and handling.

Ham Radio's Bookstore

Greenville, NH 03048

UNIVERSAL COMMUNICATIONS

A Division of
Innovative Labs, Inc.

For information or ordering
(817) 860-1641

MC, VISA, Phone or Mail Orders Accepted.
Hours, 8:30-4:30 CST; Mon.-Fri.

VIDEO STABILIZER KIT

Video Stabilizers are used to eliminate rolling and unviewable pictures when viewing pre-recorded video tapes. A must for all VCR owners.

TMVS-1 Kit \$55.00

Assembled and Tested \$70.00
For use between two VCRs.

TMVS-IRF Kit \$79.00

Assembled and Tested \$99.00
Built-in RF modulator for direct connection from VCR to TV.

SUPERVERTER I KIT \$99.95

The ultimate in converter technology! Dual stage selective preamp, mixer, i.f. amplifier and no-drift crystal controlled oscillator. We recommend this kit for the experienced kit builder. No crystal supplied.

Without preamp \$59.95

Superverter I built and tested \$149.95

12 V. Stationary Power Supply \$24.95

SELECTIVE PREAMP \$39.95

This new unit is not like other wide band preamps. Experienced kit builders can easily add this unit to our existing boards or to other manufactured boards to improve overall performance.

2300 MHz Downconverter \$35.00

PC Board, all components and instructions for a working unit.

VARIABLE POWER SUPPLY \$24.95

Complete kit includes all components for working unit including deluxe box and overlays.

DISH YAGI ANTENNA \$25.00

Complete kit with PVC and mounting brackets. Stronger than loop yagi, equal in gain.

KD44 Antenna \$54.95

Overall 25 dB gain. Partial assembly required. Shipped UPS ground only.

Our product may be copied, but the performance is never equaled.

UNIVERSAL COMMUNICATIONS P.O. Box 339
Arlington, TX 76004-0339



SURGE SHUNT



protects solid state communications equipment from damage caused by high-voltage transients entering the antenna system

These transients usually are caused by atmospheric static discharges or nearby lightning strikes.

The new Model 1549 Surge Shunt can be used with both receivers and transceivers having up to 200 watts output.

Convenient UHF type coaxial connections are supplied. Price is \$24.95

The arrester "pill" element has a long life, but can be easily and economically replaced if necessary.

Credit-Card buyers may call toll free 1-800-543-5612



In Ohio, or for information call: 1-513-866-2421

R. L. DRAKE COMPANY

540 Richard Street, Miamisburg, Ohio 45342

INSTITUTIONAL AND DEALER INQUIRIES INVITED

THE LAST WORD IN READERS

THE NEW AEA MBA-RO



FEATURES:

- 32 CHARACTERS FOR EASY HIGH SPEED COPY OF MORSE
- ASCII and BAUDOT RTTY
- NO RECEIVER MODIFICATION NECESSARY
- INSTANT SPEED TRACKING FOR MORSE CODE OVER WIDE SPEED RANGE FROM 2 TO 99 WPM
- OPERATES FROM 12 V.D.C.

For AEA Readers or other AEA Products, call or visit:

AEA
Brings you the Breakthrough!

Radios Unlimited

1760 Easton Avenue
Somerset, N.J. 08873
(201) 469-4599

The HD-73 Rotator by Alliance

**A precision instrument
built to last.**

The HD-73 combines Dual-Speed rotation and a single 5-position switch with the clear visibility of a backlit D'Arsonval meter. So you get precise control for fast and fine tuning.

And the advanced technology of HD-73 is backed by quality construction. Heavy duty aluminum casings and hardened steel drive gears. Lifetime factory lubrication that

withstands -20°F. to 120°F. temperatures.

The superior design of the HD-73 mast support bracket, with optional no-slip positive drive, assures perfect in-tower centering with no special tools.

Automatic braking minimizes inertia stress.

Easy to install, a pleasure to use.

The HD-73 is on your wavelength.

Write for performance details today.



I want to tune in on HD-73.

- Send complete details
 Give me the name of my nearest dealer.

NAME _____

ADDRESS _____

CITY _____ STATE _____ ZIP _____



The Alliance Manufacturing Company, Inc.,
Alliance, Ohio 44601

BRITT'S

2-WAY

sales and
service

Dan Britt
K4URK

RADIO

Dan's got Yaesu!



From HF to VHF — you name it,
Yaesu makes it, Dan has it.

Full line of accessories in stock



Britt's 2-Way Radio

2508 Atlanta St.

Smyrna, GA 30080

Belmont Hills Shopping Center

(404) 432-8006

ORR BOOKS

BEAM ANTENNA HANDBOOK

by Bill Orr, W6SAI

Recommended reading. Commonly asked questions like: What is the best element spacing? Can different yagi antennas be stacked without losing performance? Do monoband beams outperform tribanders? Lots of construction projects, diagrams, and photos. 198 pages. ©1977. 1st edition.

RP-BA **Softbound \$5.95**

SIMPLE LOW-COST WIRE ANTENNAS

by Bill Orr, W6SAI

Learn how to build simple, economical wire antennas. Apartment dwellers take note! Fool your landlord and your neighbors with some of the "invisible" antennas found here. Well diagramed. 192 pages. ©1972.

RP-WA **Softbound \$6.95**

THE RADIO AMATEUR ANTENNA HANDBOOK

by William I. Orr, W6SAI and Stuart Cowan, W2LX

Contains lots of well illustrated construction projects for vertical, long wire, and HF/VHF beam antennas. There is an honest judgment of antenna gain figures, information on the best and worst antenna locations and heights, a long look at the quad vs. the yagi antenna, information on baluns and how to use them, and new information on the popular Sloper and Delta Loop antennas. The text is based on proven data plus practical, on-the-air experience. **The Radio Amateur Antenna Handbook** will make a valuable and often consulted reference. 190 pages. ©1978.

RP-AH **Softbound \$6.95**

ALL ABOUT CUBICAL QUAD ANTENNAS

by Bill Orr, W6SAI

The cubical quad antenna is considered by many to be the best DX antenna because of its simple, lightweight design and high performance. You'll find quad designs for everything from the single element to the multi-element monster quad, plus a new, higher gain expanded quad (X-Q) design. There's a wealth of supplementary data on construction, feeding, tuning, and mounting quad antennas. 112 pages. ©1977.

RP-CQ **Softbound \$4.75**

Please add \$1.00 to cover shipping and handling.

HAM RADIO'S BOOKSTORE

GREENVILLE, NH 03048

17400

SN7400N	.20	SN7412N	.25	SN7416N	.75
SN7401N	.20	SN7413N	.35	SN7417N	.60
SN7402N	.25	SN7414N	.35	SN7418N	.80
SN7403N	.25	SN7415N	.40	SN7419N	.80
SN7404N	.25	SN7416N	.50	SN7420N	.80
SN7405N	.25	SN7417N	5.00	SN7421N	.80
SN7406N	.35	SN7408N	5.00	SN7422N	.80
SN7407N	.35	SN7422N	.99	SN7423N	.80
SN7408N	.35	SN7423N	.99	SN7424N	1.25
SN7409N	.29	SN7424N	.99	SN7425N	2.75
SN7410N	.29	SN7425N	.99	SN7426N	1.95
SN7411N	.29	SN7426N	1.75	SN7427N	4.95
SN7412N	.35	SN7427N	.99	SN7428N	1.39
SN7413N	.40	SN7428N	.59	SN7429N	1.29
SN7414N	.40	SN7429N	1.45	SN7430N	.89
SN7415N	.29	SN7430N	.45	SN7431N	.79
SN7417N	.29	SN7431N	.69	SN7432N	.79
SN7420N	.25	SN7432N	.69	SN7433N	1.49
SN7421N	.25	SN7433N	.69	SN7434N	1.49
SN7422N	.45	SN7434N	3.00	SN7435N	2.25
SN7423N	.29	SN7435N	.89	SN7436N	2.49
SN7424N	.29	SN7436N	1.49	SN7437N	2.80
SN7425N	.29	SN7437N	1.89	SN7438N	2.49
SN7426N	.29	SN7438N	2.49	SN7439N	1.25
SN7427N	.25	SN7439N	.35	SN7440N	1.50
SN7428N	.25	SN7440N	.89	SN7441N	1.95
SN7429N	.25	SN7441N	1.95	SN7442N	1.95
SN7430N	.25	SN7442N	1.95	SN7443N	1.95
SN7431N	.25	SN7443N	1.95	SN7444N	1.95
SN7432N	.25	SN7444N	1.95	SN7445N	1.95
SN7433N	.25	SN7445N	1.95	SN7446N	.79
SN7434N	.25	SN7446N	1.95	SN7447N	.69
SN7435N	.25	SN7447N	.69	SN7448N	.69
SN7436N	.25	SN7448N	.69	SN7449N	.69
SN7437N	.25	SN7449N	.69	SN7450N	.69

Bulova Quartz Ladies Watches

ONE YEAR FACTORY WARRANTY

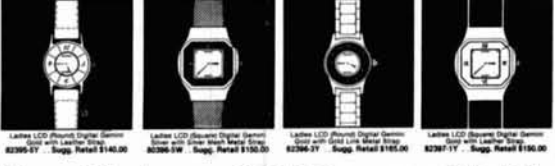

Your Choice — \$69.95 ea. any Model

CALL OR SEND ORDER IN REFERENCE TO THIS AD FOR SPECIAL PRICE
Because of Limited Supply, please provide a second and third choice

LITRONIX Stick Display Sale

MULTI-DIGIT REFLECTOR ARRAYS FOR CLOCKS

Part No.	Display	Price	2 For Sale
72241JL	10 Digit 100MHz	1.38	\$27.60
72241JA	10 Digit 100MHz	1.38	\$27.60
72241JL	10 Digit 100MHz	1.38	\$27.60
72241JA	10 Digit 100MHz	1.38	\$27.60
72241JL	10 Digit 100MHz	1.38	\$27.60

MULTI-DIGIT REFLECTOR ARRAYS

Part No.	Display	Price	2 For Sale
72241JL	10 Digit 100MHz	1.38	\$27.60
72241JA	10 Digit 100MHz	1.38	\$27.60

NATIONAL Stick Display Sale

LED NUMERIC DISPLAYS

Part No.	Display	Price	2 For Sale
72241JL	10 Digit 100MHz	1.38	\$27.60
72241JA	10 Digit 100MHz	1.38	\$27.60
72241JL	10 Digit 100MHz	1.38	\$27.60
72241JA	10 Digit 100MHz	1.38	\$27.60
72241JL	10 Digit 100MHz	1.38	\$27.60

17400

74L500	.29	74LS192	1.15
74L501	.29	74LS193	1.15
74L502	.29	74LS194	1.15
74L503	.29	74LS195	1.15
74L504	.29	74LS196	1.15
74L505	.29	74LS197	1.15
74L506	.29	74LS198	1.15
74L507	.29	74LS199	1.15
74L508	.29	74LS200	1.15
74L509	.29	74LS201	1.15
74L510	.29	74LS202	1.15
74L511	.29	74LS203	1.15
74L512	.29	74LS204	1.15
74L513	.29	74LS205	1.15
74L514	.29	74LS206	1.15
74L515	.29	74LS207	1.15
74L516	.29	74LS208	1.15
74L517	.29	74LS209	1.15
74L518	.29	74LS210	1.15
74L519	.29	74LS211	1.15
74L520	.29	74LS212	1.15
74L521	.29	74LS213	1.15
74L522	.29	74LS214	1.15
74L523	.29	74LS215	1.15
74L524	.29	74LS216	1.15
74L525	.29	74LS217	1.15
74L526	.29	74LS218	1.15
74L527	.29	74LS219	1.15
74L528	.29	74LS220	1.15
74L529	.29	74LS221	1.15
74L530	.29	74LS222	1.15
74L531	.29	74LS223	1.15
74L532	.29	74LS224	1.15
74L533	.29	74LS225	1.15
74L534	.29	74LS226	1.15
74L535	.29	74LS227	1.15
74L536	.29	74LS228	1.15
74L537	.29	74LS229	1.15
74L538	.29	74LS230	1.15
74L539	.29	74LS231	1.15
74L540	.29	74LS232	1.15
74L541	.29	74LS233	1.15
74L542	.29	74LS234	1.15
74L543	.29	74LS235	1.15
74L544	.29	74LS236	1.15
74L545	.29	74LS237	1.15
74L546	.29	74LS238	1.15
74L547	.29	74LS239	1.15
74L548	.29	74LS240	1.15
74L549	.29	74LS241	1.15
74L550	.29	74LS242	1.15

17400

74LS00	.29	74LS192	1.15
74LS01	.29	74LS193	1.15
74LS02	.29	74LS194	1.15
74LS03	.29	74LS195	1.15
74LS04	.29	74LS196	1.15
74LS05	.29	74LS197	1.15
74LS06	.29	74LS198	1.15
74LS07	.29	74LS199	1.15
74LS08	.29	74LS200	1.15
74LS09	.29	74LS201	1.15
74LS10	.29	74LS202	1.15
74LS11	.29	74LS203	1.15
74LS12	.29	74LS204	1.15
74LS13	.29	74LS205	1.15
74LS14	.29	74LS206	1.15
74LS15	.29	74LS207	1.15
74LS16	.29	74LS208	1.15
74LS17	.29	74LS209	1.15
74LS18	.29	74LS210	1.15
74LS19	.29	74LS211	1.15
74LS20	.29	74LS212	1.15
74LS21	.29	74LS213	1.15
74LS22	.29	74LS214	1.15
74LS23	.29	74LS215	1.15
74LS24	.29	74LS216	1.15
74LS25	.29	74LS217	1.15
74LS26	.29	74LS218	1.15
74LS27	.29	74LS219	1.15
74LS28	.29	74LS220	1.15
74LS29	.29	74LS221	1.15
74LS30	.29	74LS222	1.15
74LS31	.29	74LS223	1.15
74LS32	.29	74LS224	1.15
74LS33	.29	74LS225	1.15
74LS34	.29	74LS226	1.15
74LS35	.29	74LS227	1.15
74LS36	.29	74LS228	1.15
74LS37	.29	74LS229	1.15
74LS38	.29	74LS230	1.15
74LS39	.29	74LS231	1.15
74LS40	.29	74LS232	1.15
74LS41	.29	74LS233	1.15
74LS42	.29	74LS234	1.15
74LS43	.29	74LS235	1.15
74LS44	.29	74LS236	1.15
74LS45	.29	74LS237	1.15
74LS46	.29	74LS238	1.15
74LS47	.29	74LS239	1.15
74LS48	.29	74LS240	1.15
74LS49	.29	74LS241	1.15
74LS50	.29	74LS242	1.15

COMPUTER GRADE CAPACITORS

MFD	VWDC	PRICE	MFD	VWDC	PRICE	MFD	VWDC	PRICE
1000	25	1.95	10000	15	2.95	10000	15	2.95
1000	50	2.95	10000	30	3.95	10000	30	3.95
1000	100	3.95	10000	60	4.95	10000	60	4.95
1000	250	4.95	10000	120	5.95	10000	120	5.95
1000	500	5.95	10000	250	6.95	10000	250	6.95
1000	1000	6.95	10000	500	7.95	10000	500	7.95
1000	2000	7.95	10000	1000	8.95	10000	1000	8.95
1000	5000	8.95	10000	2000	9.95	10000	2000	9.95
1000	10000	9.95	10000	5000	10.95	10000	5000	10.95
1000	20000	10.95	10000	10000	11.95	10000	10000	11.95
1000	50000	11.95	10000	20000	12.95	10000	20000	12.95
1000	100000	12.95	10000	50000	13.95	10000	50000	13.95
1000	200000	13.95	10000	100000	14.95	10000	100000	14.95
1000	500000	14.95	10000	200000	15.95	10000	200000	15.95
1000	1000000	15.95	10000	500000	16.95	10000	500000	16.95
1000	2000000	16.95	10000	1000000	17.95	10000	1000000	17.95
1000	5000000	17.95	10000	2000000	18.95	10000	2000000	18.95
1000	10000000	18.95	10000	5000000	19.95	10000	5000000	19.95
1000	20000000	19.95	10000	10000000	20.95	10000	10000000	20.95
1000	50000000	20.95	10000	20000000	21.95	10000	20000000	21.95
1000	100000000	21.95	10000	50000000	22.95	10000	50000000	22.95
1000	200000000	22.95	10000	100000000	23.95	10000	100000000	23.95
1000	500000000	23.95	10000	200000000	24.95	10000	200000000	24.95
1000	1000000000	24.95	10000	500000000	25.95	10000	500000000	25.95

LOW PROFILE (TIN) SOCKETS

8 pin LP	.17	16	.15	14 pin ST	.27	25	.49	50-100
14 pin LP	.20	19	.18	16 pin ST	.30	27	.26	
16 pin LP	.22	21	.20	18 pin ST	.35	32	.40	
18 pin LP	.25	28	.27	20 pin ST	.40	45	.42	
20 pin LP	.34	32	.30	22 pin ST	.45	50	.81	
22 pin LP	.37	36	.35	24 pin ST	.99	90	1.15	
24 pin LP	.38	37	.36	26 pin ST	1.39	126	1.50	
26 pin LP	.40	44	.43	40 pin ST	1.59	145	1.30	
36 pin LP	.65	59	.58					
40 pin LP	.63	62	.61					

SOLDERTAL (GOLD) STANDARD

8 pin SG	.29	35	.31	16 pin WW	.59	54	.49	50-100
14 pin SG	.49	45	.41	18 pin WW	.85	77	.70	
16 pin SG	.54	49	.44	18 pin WW	.99	90	.81	
18 pin SG	.59	53	.48	20 pin WW	1.19	108	.99	
20 pin SG	.79	75	.69	22 pin WW	1.49	135	1.23	
24 pin SG	1.10	100	.99	24 pin WW	1.39	126	1.14	
26 pin SG	1.55	140	1.26	28 pin WW	1.69	153	1.38	
40 pin SG	1.75	159	1.45	36 pin WW	2.19	192	1.75	
				40 pin WW	2.29	209	1.89	

1/4 WATT RESISTOR ASSORTMENTS - 5%

ASST. 1	500	10 Ohm 12 Ohm 15 Ohm 18 Ohm 22 Ohm 27 Ohm 33 Ohm 39 Ohm 47 Ohm 56 Ohm	50pcs.	\$1.95
ASST. 2	500	68 Ohm 82 Ohm 100 Ohm 120 Ohm 150 Ohm 180 Ohm 220 Ohm 270 Ohm 330 Ohm 390 Ohm	50pcs.	\$1.95
ASST. 3	500	470 Ohm 560 Ohm 680 Ohm 820 Ohm 1K	1K	\$1.95
ASST. 4	500	1.2K 1.5K 1.8K 2.2K 2.7K 3.3K	500pcs.	\$1.95
ASST. 5	500	22K 27K 33K 39K 47K 56K 68K 82K 100K 120K	500pcs.	\$1.95
ASST. 6	500	150K 180K 220K 270K 330K 390K 470K 560K 680K 820K	500pcs.	\$1.95
ASST. 7	500	1M 1.2M 1.5M 1.8M 2.2M 2.7M 3.3M 3.9M 4.7M 5.6M	500pcs.	\$1.95</



IC-22U

2 meter, FM, 10W, 800 channel, synthesized. Frequency selection remotable with EX199 adapter. Compact, easy to use, affordable.



TOP OF THE LINE NUMBER ONE

If you're the type of person that will settle for nothing less, we've got what you're looking for... top of the line. We offer more than just the rigs - super service after the sale. Call us soon for a quote on your next rig.

Call Us
TOLL FREE
For All Your Radio &
Computer Needs
800-845-6183

SERVICE DEPT.
803-366-7158



IC-290A

2 meter multimode mobile, 12 VDC, 10 W. out, FM, SSB, CW, Priority channel, scanning, CW sidetone, squelch on SSB.



IC-25A

ICOM's small size (only 5 1/2" wide) 2 meter FM transceiver. Featuring 25 W. out, Priority channel, scanning, 5 memories. Touchtone® mic standard at no extra cost.

G.I.S.M.O.
1039 LATHAM DRIVE
ROCK HILL, S. C. 29730



IC-2AT

ICOM's popular 2 meter, 800 channel, compact, handheld transceiver with Touchtone® builtin. Comes standard with BP3 (250 mAh) battery, wall charger, belt clip, flexible antenna. A wide variety of batteries and accessories available.



FAST SCAN

*\$249

A modular approach... for your own custom-designed ATV system... Here's how

TXA5-4 ATV EXCITER/MODULATOR \$89 ppd

This wired and tested module is designed to drive the Motorola MHW 710 module in the PA5 10 watt linear amp. The crystal in the 100 MHz region keeps harmonics out of two meters for talk back. The video modulator is full 8 MHz for computer graphics and color. Requires 13.8 vdc reg @ 70 ma. Tuned with xtal on 439.25, 434.0, or 426.25 mhz. Provision for sync expanding. Two frequencies available.



PA5 10 WATT ATV POWER MODULE \$89 ppd

The PA5 will put out 10 watts RMS power on the sync tips when driven with 80 mw by the TXA5 exciter 50 ohms in and out, plus bandwidth for the whole band with good linearity for color and sound. Requires 13.8 vdc regulated @ 3 amps.



FMA5 AUDIO SUBCARRIER GENERATOR

..... \$29 ppd

Puts audio on with your camera video just as broadcast TV does at 4.5 mhz. Puts out up to 1 v p-p to drive the TXA5 or VM-2, 3, or 4 modulators. Requires low Z mic (150 to 600 ohms), and +12 to 18 vdc @ 25 ma. Works with any xmtr with 5 mhz video bandwidth.



TVC-2 ATV DOWNCONVERTER... \$55 ppd

Stripline MRF901 (1.7 db NF) preamp and double balanced mixer module digs out the weak ones but resists intermods and overload. Connects between uhf antenna and TV set tuned to channel 2 or 3. Varicap tunes 420 to 450 mhz. Requires +12 to 18 vdc @ 20 ma. Super sensitive TVC-2L with NE64535 preamp (9db NF) stage. \$69 ppd.



*TXA5, PA5, FMA5 and TVC Basic Module Pkg.

Call or write for our complete list of specifications, station set-up diagrams, and optional accessories which include antennas, modulators, detectors, test generators, cameras, etc. **WE ARE A FULL-LINE SUPPLIER OF ALL YOUR ATV NEEDS.**

TERMS: VISA or MASTER CARD by telephone or mail, or check or money order by mail. All prices are delivered in USA. Allow three weeks after order for delivery.

(213) 447-4565 Charge card orders only

P.C. ELECTRONICS 2522 Paxson Lane,
Tom W6ORG Maryann WB6YSS Arcadia, California 91006

A NEW GENERATION of REPEATER CONTROLLERS MS 101

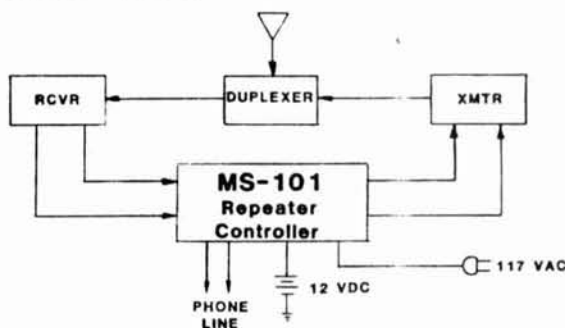

- 4 ACCESS MODES
- AUTOPATCH
- AUTODIAL (72 No.)
- REVERSE AUTOPATCH
- 16 DIGIT XTAL CONTROLLED TOUCH TONE DECODER
- COMPLETE RX, TX, & PHONE AUDIO INTERFACE W/MUTING
- EASY TO CHANGE CONTROL CODES
- TRANSISTOR BUFFERED INPUTS
- 60 CONTROL FUNCTIONS
- 12 VDC & 117 VAC OPERATION
- 30 TIMERS
- MASTER RCVR CONTROL
- 2 XCVR LINKS
- 2 CW IDs
- HI/LO FREQ. INDICATOR
- RELAY DRIVER OUTPUTS
- OPTIONAL VOICE SYNTH.

wired & tested \$849.25 MS-301 Voice synth. \$219.95

MICRO SECURITY

9307 MEADOWS LANE
GREENFIELD, IN 46140
(317) 894-1201



Valor's PRO-AM line

Valor Enterprises introduces a new line of PRO-AM (Professional-Amateur) antennas, mounts, and accessories. Valor's PRO-AM line is compatible and interchangeable with the Motorola TAD and TAE type mounts. This system is used extensively in commercial two-way and Amateur

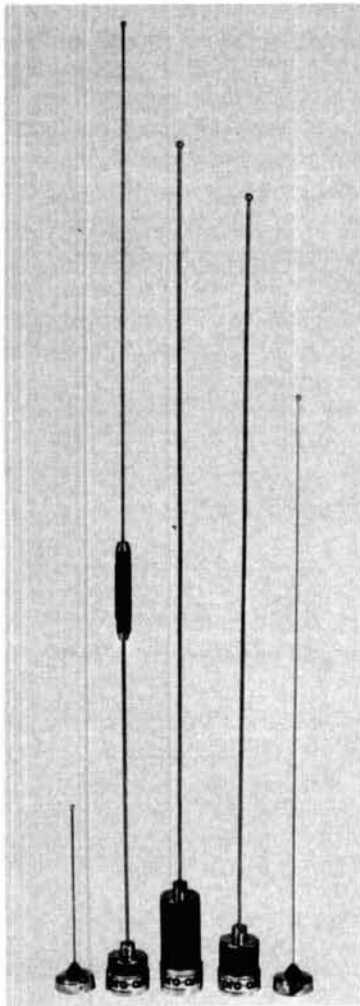

PRO-AM antennas. From left, Models PAQ, PUB, PLB, and PAQ.

applications. Two basic mounts offer installation into a 3/4-inch or 3/8-inch hole; both utilize a 1-1/8 — 18 thread for mating parts. All components are inspected and tested to rigid commercial standards to insure performance in the most demanding environments. Quality materials include stainless steel whips and set screws, nickel-chrome brass parts, heavy gauge weather-proof coils, nickel-silver contacts, and O-ring seals.

Four mounts are offered: Model PAS, the basic surface mount that installs in a 3/4-inch hole in roof, fender, or cowl. Includes 17-inches RG-58 with PL-259 connector; Model PAS38, the basic surface mount that installs in 3/8 inch hole in roof, fender, or cowl; Model PAT, a heavy-duty no-hole trunk mount. Black ABS cup, 17 inches RG-58 with PL-259 connector; Model PAM, a low-profile, chrome-plated magnet mount with 12 inches RG-58 with PL-259 connector.

PRO-AM antennas are divided into four types: Model PLB, a 1/4-wave base-loaded low-band antenna. Five models cover 27-54 MHz. 200-watt power-rated, with cutting chart; Model PAQ, 1/4-wave, unity-gain VHF-UHF whips. Twelve models cover 136-866 MHz. Passivated 302 s.s. whips factory tuned, ready to install. Nickel-chrome brass base, 150-watt power-rated; Model PHB, a 5/8-wave, 3 dB-gain VHF antenna. Two models cover 144-174 MHz and 220-225 MHz. 200-watt power-rated, with cutting chart; Model PUB, a collinear 5-dB-gain UHF antenna. Four models cover 440-512 MHz. 200-watt power-rated, with cutting chart.

For more information, contact Valor Enterprises, Inc., 185 West Hamilton Street, West Milton, Ohio 45338; telephone 513-698-4194 or 1-800-543-2197.

Code*Star

Microcraft announces its new all-mode code reader and code converter, Code*Star. Code*Star is designed

for novices, SWLs, and veteran Amateurs. It should also be very useful to people learning or trying to improve their Morse code skills.

Code*Star's microcomputer monitors the incoming signal and converts it to characters on its large, easy-to-read LEDs. It decodes Morse code, Baudot (RTTY) and ASCII code.

Code*Star features two specially optimized Morse code ranges with auto-tracking of speed from 3 to 70 WPM. Special proprietary analog and digital filter methods are employed to substantially reduce errors. An automatic gain control circuit providing up to 16 dB gain is used to help maintain signals under fading conditions. A built-in code practice oscillator is handy for code practice and learning the code.

Code*Star operates on 12 Vdc which makes it ideal for field or mobile applications. An ac adapter is included if you wish to operate it from 120 Vac. As a special option you can use Code*Star to drive a serial or parallel ASCII printer, TV terminal or computer.

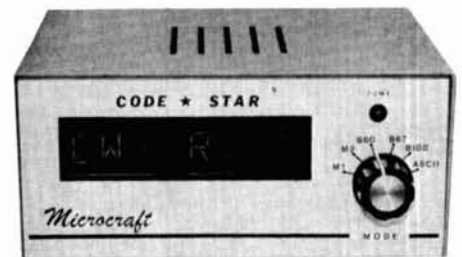

Code*Star is available as a complete kit or factory wired and tested. The kit, Model CS-K, sells for \$169.95 plus \$5.00 shipping and handling. The factory wired version, Model CSF, sells for \$249.95 plus \$5.00 shipping and handling. The optional ASCII output port kit, Model CS-1K, sells for \$69.95 plus \$2.50 shipping and handling.

For more information, contact Microcraft Corporation, P.O. Box 513, Thiensville, Wisconsin 53092; telephone 414-241-8144.



NEW MORSEMATIC™ MM-2 KEYS

THE MORSEMATIC KEYS BY AEA HAS BEEN PROCLAIMED BEST OF ALL PADDLE KEYS ON THE MARKET

NEW ... \$139.95

Now you can get all the features of the world's first and still best microcomputerized keyer at a 30% reduction in price. The new model MM-2 has all the outstanding features of the MM-1 predecessor such as dual microcomputers with copywritten software, 500 character soft-partitioned™ memory with editing, exclusive beacon mode, exclusive automatic speed increase trainer mode, and exclusive automatic serial number generator. In addition, the MM-2 comes complete with CMOS memory and provisions for internal memory keep alive battery. The MM-2 operates from external 12 VDC at approximately 350 Ma.

ACCESSORIES:

Model AC-1 600 Ma 12 VDC Wall Adaptor \$14.95
 Model ME-2 Memory Expansion (2000 Total Morse Characters) \$39.95

If you have hesitated buying the best because of price, you need to wait no longer, the best is now available in an improved form at a price you can afford.

PRICES AND SPECIFICATIONS SUBJECT TO CHANGE WITHOUT NOTICE

call or visit:

AEA
 Brings you the
 Breakthrough!

G & K Amateur Supply

2920 East 9th Street
 Des Moines, Iowa 50316
 (515) 262-1745



35-watt, 2-meter amp

The Model 335A-K is an improved version of our reliable Model 335 amplifier kit. The Model 335A-K represents the latest in the state-of-the-art in 2-meter amplifier design. It incorporates new features which make it one of the most useful amplifiers available today.

The Model 335A-K is a linear amplifier and can be used on fm, SSB, or CW. The Model 335A-K can be used with all available handhelds (TR2400, TR2500, IC-2AT, Yaesu, Santec, etc.) and low power SSB transmitters to give added range and versatility.

The Model 335A-K can be assembled easily in one evening using the step-by-step instruction manual. The quality parts and rugged construction used throughout the Model 335A-K make it a very reliable amplifier. When you construct the amplifier yourself, not only will you be saving money, but you will also experience the pleasure of constructing some of your own gear.

For more information, contact Communication Concepts, Inc., 2648 N. Aragon Ave., Dayton, Ohio 45420; telephone 513-296-1411.

UNARCO-ROHN

Self Supporting Towers On Sale!

During April these rugged beauties are being offered at Big Discounts and — we are shipping them **freight prepaid!** Look over the specifications and pick the unit most suited for your needs. Call us to place your order with Mastercard/Visa or write and include your check for quick shipment — **Freight Prepaid!**

Save even more — include antenna and rotor of your choice with the order and we will ship them along **freight prepaid** also! How's that for good old-fashioned savings?

FREIGHT PREPAID

Tower Model	Tower Ht.	Load Rating	Ship Weight	Tower Base	Tower Price	Base Price	Total Price
HBX40	40 ft	10 sq ft	164	BXB6	269	24	293
HBX48	48 ft	10 sq ft	303	BXB7	349	26	375
HBX56	56 ft	10 sq ft	385	BXB8	419	30	449
HDBX40	40 ft	18 sq ft	281	BXB7	313	26	339
HDBX48	48 ft	18 sq ft	363	BXB8	399	30	429

FLASH!!!

OFFER EXTENDED 1 EXTRA MONTH

Cushcraft		
A3	\$169
A4	\$209
HYGAIN		
TH3MK3	\$179
TH5DX	\$209
TH7DX	\$339
KLM		
KT34A	\$319
KT34XA	\$479
Rotators		
HD73	\$99
Ham IV	\$169
Tailtwister	\$239

ORDER TODAY!!

TEXAS TOWERS

A DIVISION OF TEXAS RF DISTRIBUTORS, INC.
 1108 SUMMIT AVE., SUITE 4 — PLANO, TEXAS 75074
 Mon.-Fri.: 8:30 a.m.-5:30 p.m. Saturday: 9:00 a.m.-1:00 p.m.
 TELEPHONE: (214) 422-7306

FREE BOOK CATALOG

SEE PAGE 78

Ham Radio's Bookstore
 Greenville, NH 03048

TIDBITS

THE PRACTICAL HANDBOOK OF AMATEUR RADIO FM & REPEATERS

by Bill Pasternak, WA6ITF

Comprehensive handbook covers just about every facet of FM operation in a simple, easy to understand manner. 45 chapters put all kinds of FM and Repeater topics within easy reach. You get a solid background in FM theory, control devices for repeaters, how to build a repeater, ATV and RTTY application ideas and more. This huge, fact-filled repeater book is a must for anyone interested in FM communication. ©1980, 536 pages, 1st edition.

T-1212 Softbound \$12.95

Please add \$1.00 for shipping and handling.

HAM RADIO'S BOOKSTORE
 Greenville, NH 03048

CES 500SA autopatch

The new CES 500SA simplex autopatch is a high-quality unit that is surprisingly versatile and affordable (\$350.00 suggested retail price). It provides positive radio operator control and eliminates telephone VOX circuits with a proprietary noise-gated sampling circuit.



Suggested applications for the Model 500SA include mobile/remote base to telephone line via simplex base; mobile to mobile via phone-interconnected base stations (for greatly extended range); and telephone line to mobile/remote base.

For more information on CES 500SA autopatch and other quality CES products, contact CES, Inc., Post Office Box 507, Winter Park, Florida, or telephone (305) 645-0474.

field-tuneable antenna

Centurion International has introduced a new field-tuneable replacement antenna for hand-held radios in the range of 66-88 MHz.

The new flexible antenna is available with any of the twenty-five different connector configurations in the standard Centurion line. This selection ensures high performance replacements for virtually any radio antenna in this band.



Centurion field-tuneable antennas are protected by a neoprene jacket with flexibility between -55°C and 100°C. The jacket is self-extinguishing when exposed to flame. Approximate length is 10 inches.

For more information, contact Centurion International, P.O. Box 82846, Lincoln, Nebraska 68501-2846; telephone 402-467-4491.

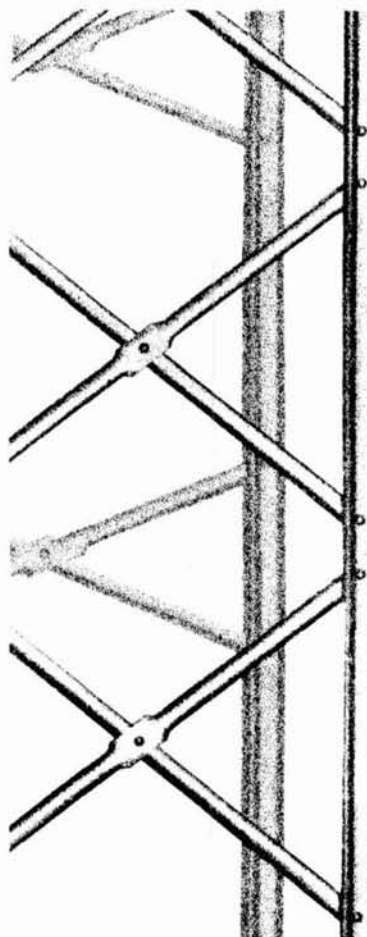

Rohn 'BX' TOWERS

- For Home TV, Ham Radio and CB.
- Up to 18 sq. ft. antenna capacity.
- Available to 64' in 8' sections.
- All riveted construction — no welds.
- Beaded channel leg for added strength.
- All steel — galvanized for added life.
- Can be used with Concrete Base Stubs, Cylinder Base or Hinged Concrete Base.

G UNR-Rohn

Division of UNR Industries, Inc.
6718 West Plank Road, P.O. Box 2000
Peoria, Illinois 61656
U.S.A.

Homebrew Headquarters

Receive 2 meters on your HF rig

April Issue 73
Input 144-146 MHz
Output 28-30 MHz
NF < 2 db
Power 8-16V, 15 mA
Size 2-3/4 X 2-3/8 X 7/8

Other kits, pc boards and parts for amateurs available.
Send for catalog.

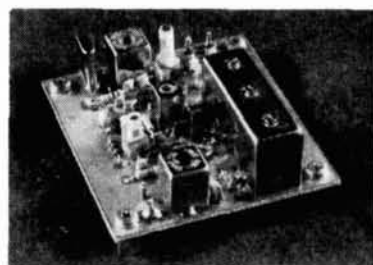

2 Meter Converter

Shown less Enclosure

RADIOKIT

Box 411H, Greenville, NH 03048
(603) 878-1033

1982 Catalog — 50 cents

SEND FOR NEW 1982
Free! 40 PAGE CATALOG Free!

**FLAT LEVER
MINI-TOGGLE
S.P.D.T. (ON-ON)**

C & K 7101
STANDARD FLAT LEVER
RATED: 5AMP
@125 VOLTS
1/4X40 BUSHING

\$1.00 EACH
10 for \$ 8.50
100 for \$75.00

**18 VOLT at 350 MILL
TRANSFORMER**

**COMPUTER GRADE
CAPACITORS**
25,000 mfd. 75 VDC \$4.50
45,000 mfd. 25 VDC \$3.50
72,000 mfd. 15 VDC \$3.50
2" DIA X 4" HIGH

ALL ELECTRONICS CORP.

905 S. Vermont Ave.
P.O. BOX 20406
Los Angeles, Calif. 90006
(213) 380-8000

Mon. - Fri. Saturday
9 AM - 5 PM 10 AM - 3 PM

TERMS
• Quantities Limited
• Min. Order \$10.00
• Add \$ 2.50
Shipping USA
• Calif. Res. Add 6%
• Prompt Shipping

RED HOT SPECIALS

AZDEN PCS 3000 2m Xcvr.....	283.00
SANTEC 144 up 2m Handheld	297.00
KDK 2025A MkII w/TT Mike	265.00
JANEL QSA5 2m Preamp	36.50
BEARCAT 20-20 Scanner	269.00
KANTRONICS FDII Code Reader	360.00
All MFJ Items	12% off list
TEN-TEC Argosy Xcvr	469.00
TEN-TEC Delta Xcvr	738.00
TEN-TEC Omni D Xcvr	1040.00
TEN-TEC Hercules Amp	1297.00
AZDEN PCS 300 2m Handheld	288.00
KANTRONICS Interface	165.00

Prices subject to change without notice.
SASE for our Large Specials
and Used Equipment Lists

BEN FRANKLIN ELECTRONICS

115 1/2 N. Main Hillsboro, KS 67063
316-947-2269

WARNING

SAVE YOUR LIFE OR AN INJURY

Base plates, flat roof mounts, hinged bases, hinged sections, etc., are not intended to support the weight of a single man. Accidents have occurred because individuals assume situations are safe when they are not.

Installation and dismantling of towers is dangerous and temporary guys of sufficient strength and size should be used at all times when individuals are climbing towers during all types of installations or dismantlings. Temporary guys should be used on the first 10' or tower during erection or dismantling. Dismantling can even be more dangerous since the condition of the tower, guys, anchors, and/or roof in many cases is unknown.

The dismantling of some towers should be done with the use of a crane in order to minimize the possibility of member, guy wire, anchor, or base failures. **Used towers in many cases are not as inexpensive as you may think if you are injured or killed.**

Get professional, experienced help and read your Rohn catalog or other tower manufacturers' catalogs before erecting or dismantling any tower. A consultation with your local, professional tower erector would be very inexpensive insurance.

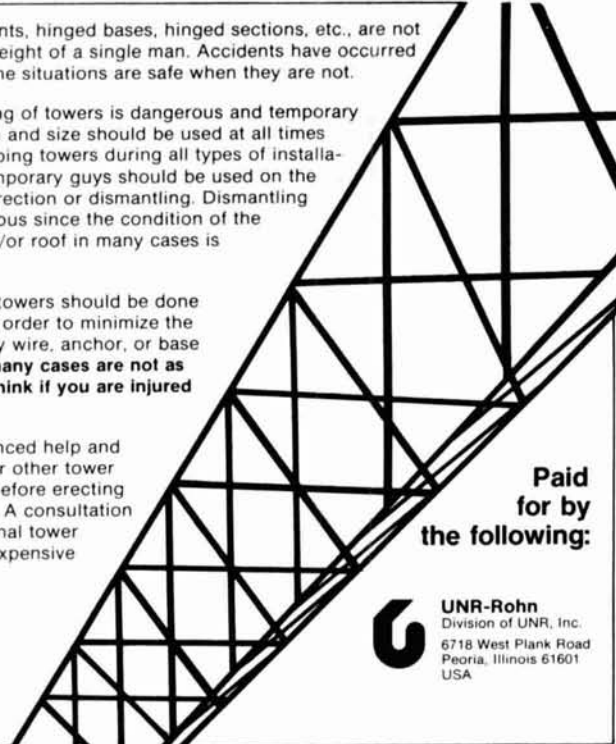

Paid for by the following:

UNR-Rohn
Division of UNR, Inc.
6718 West Plank Road
Peoria, Illinois 61601
USA



XZ-2 audio CW filter

Long known as a manufacturer of quality keys and baluns, Bencher now introduces the XZ-2 audio filter. As mentioned in D.A. Tong's article in the November, 1981, issue of *ham radio*, now that almost all receivers in use by hams feature good basic selectivity, it only makes sense to perform final bandwidth shaping in the receiver's audio section.

Use of the XZ-2 is simple and easy. The filter has four selectivity selections: SSB, 150 Hz, 115 Hz, and 90 Hz. The XZ-2 runs on 12-16 Vdc, which can be supplied by Bencher's 12-volt accessory power supply (#190-10). Audio can be taken from a number of convenient places; Bencher suggests that the phone patch outlet may be the most convenient. For our test, we connected the filter to the external speaker plug and put the filter in line with the speaker. This method provided convenient access to the headphone jack for test purposes. Actual testing took place over several days of casual operating and during CQ's WW CW contest.

When the power is connected, the unit remains on until power is removed. There is no way to completely remove the audio filter from the line, as may be done with several other makes of external filters. This isn't a major problem, however. It means that audio is still slightly amplified by the unit but it is bypassing the filtering stages. To our ear this was a bit of an annoyance, more due to the "newness" of the audio sound rather than a degradation of performance.

To use the filter, Bencher suggests that you tune the receiver with the filter set to SSB. This will allow you to hear a wide range of signals as you tune the CW band. When you hear a station you want, switch in as much

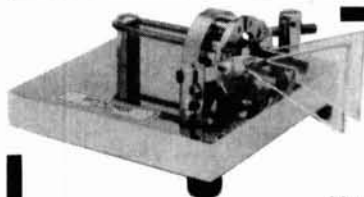

The New Standard... the Ultimate IAMBIC PADDLE

Modern CW technology at its best! Carefully engineered to make optimum use of today's keyers, the Bencher Iambic Paddle is a symphony of modern materials, design and workmanship. This is the paddle that provides the perfect interface between the CW operator and his rig. Smooth, instantly responsive and fully adjustable to suit your own touch. From the gold plated solid silver contacts to the heavy leaded steel base, it truly is the ultimate.

Standard \$42.95
Chrome \$52.95
Gold Plated \$150.00

At selected dealers or
add \$2.00 handling

Write:

BENCHER, INC. 333 W. Lake St., Chicago, IL 60606
(312) 263-1808

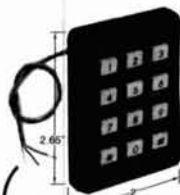

THE PROFESSIONAL, TOUCH TONE ENCODER

An ultra high quality encoder for professional application. Absolute reliability and function makes the difference. There's a Pipo encoder for every system and application. Totally serviceable, easy to operate and install. **Call or write for free catalog and information!** (213) 852-1515 or P.O. Box 3435, Hollywood, CA 90028.

PATENTED

• AT&T

Pipo Communications
Emphasis is on Quality & Reliability



NEW CATALOG OF HARD-TO-FIND PRECISION TOOLS

Lists more than 2000 items: pliers, tweezers, wire strippers, vacuum systems, relay tools, optical equipment, tool kits and cases. Send for your free copy today!

JENSEN TOOLS INC.
1230 S. PRIEST DR. - TEMPE, AZ. 85281



FREE THE GREAT ELECTRONIC THINGS & IDEAS BOOK!

HUNDREDS OF UNUSUAL PARTS, GADGETS & IDEA ITEMS, UNAVAILABLE IN STORES OR CATALOGS ANYWHERE! Bargain prices on everything! New items in every issue! Rush postcard for your copy!

ETCO ELECTRONICS
Dept. 444
Plattsburgh, N. Y. 12901

selectivity as is required to eliminate adjacent-channel interference. When you are trying to copy an exceptionally weak signal in the presence of stronger signals, Bencher suggests that you increase the audio gain and decrease the rf gain as much as possible. Reducing the rf gain will limit the AVC control by the stronger signal. While trying to muck out a weak DX signal in the presence of a very strong stateside station, we found that Bencher's suggestions worked very well and we were able to effectively null out the interference created by the adjacent frequency station.

In comparison with the receiver's internal i-f filters and passband tuning, the XZ-2 shows up quite favorably. Used in conjunction with the receiver's built-in filtering, the XZ-2 is even better.

During the CQ WW contest, the XZ-2 was used both independently and with the receiver's filters. Of note is the fact that there are switches to be switched and dials to be turned to use the unit. In the heat of the contest this can hinder speed of operation. It's our operating preference to scan with the filter on wide bandwidth and then narrow down when a station is found. We do not do a lot of contest work, and so this is not much of a problem. But for a dyed-in-the-wool contest, it will be necessary to select, and remain with, one filter position. The filter performed very well during the contest and permitted us to work a number of stations we feel confident would have been missed without the external filter.

One final note. For those who own super-selective receivers, the XZ-2 can be a very valuable addition to the hamshack. As Dr. Tong says, audio filters are the next logical step for improving station performance. We are sure you will be pleased with Bencher's XZ-2 audio filter.

The Bencher XZ-2 filter sells for \$69.95, plus \$9.95 for 12-volt power supply. For further information, contact Bencher, Inc., 333 West Lake Street, Chicago, Illinois 60606.

the editors

MIRAGE MIRAGE MIRAGE

COMMUNICATIONS EQUIPMENT, INC.
MADE IN U.S.A.

5 YEAR WARRANTY

NEW for 220!
C22 AMPLIFIER
All-mode/2W in — 20W out
200MW to 5W Drive



\$89.95



2 Meter "All Mode" Amplifiers
FM - SSB - CW

B108	10 W. in = 80 W. out	\$179.95
B1016	10 W. in = 160 W. out	279.95
B3016	30 W. in = 160 W. out	239.95
B 2 3	2 W. in = 30 W. out	89.95

These amplifiers, except B23, have built in RX preamps. The B108 and B1016 may be used with HTs or transceivers. They will key with 1 Watt input.

C106 AMPLIFIER
SSB, FM, CW
10W in — 60W out
2W in — 30W out



Dual Purpose for HT or Xcvr! **\$199.95**

RC - I Remote Control \$24.95
SEE YOUR NEAREST DEALER FOR INFORMATION

MIRAGE COMM. EQUIP., INC. • P.O. BOX 1393 • GILROY, CA 95020 • (408) 847-1857

OVER 70 BRANDS IN STOCK • LAND-MOBILE RADIO • Full Service Shop • Spectrum Analysis • Antennas
DRAKE • BIRD • HYGAIN • ARRL • New and Used Equipment • CW-SSB-FM, Etc. • Towers
ICOM • AMATEUR RADIO • FCC Study Guides • Code Tapes • Books • Accessories
SHORTWAVE
SCANNERS • BEARCAT • MORGAIN • MANY MORE...
TEN-TEC • BAW • CDE
CLOSED SUNDAYS, HOLIDAYS

SPECTRONICS
Specialists in Amateur Radio, Short-Wave Listening And Contemporary Electronic Gear.

HOURS
MON, TUES, WED.: 9:30-6:00 PM
THURS, FRI.: 9:30-8:00 PM
SAT.: 9:30-3:00 PM

SPECTRONICS, INC.
1009 GARFIELD ST. OAK PARK, IL. 60304 (312)848-6777

*** Quality Microwave Systems** 2100 to 2600 MHz Antennas 34 db Gain or Greater

Complete System (As Pictured) Ready to Install	\$149.95
Down Converter (Probe Mntd.) Assembled and Tested	64.95
Down Converter PCB (Chassis Mntd.) Assembled and Tested	64.95
Power Supply Assembled and Tested	59.95
Down Converter PCB (Chassis Mntd.) Kit w/ Parts and Data	49.95
Printed Circuit Board (Chassis Mntd.)	29.95
Data Information (Plans for Kit Building)	9.95

SEND CHECK, CASH, MONEY ORDER TO:
Phillips-Tech Electronics
P. O. Box 33205
Phoenix, Arizona 85067

For Special Quantity Pricing, C.O.D.'s. MasterCard or Visa Call:
(602) 274-2885
**Intended For Amateur Ham Use!*



6 MONTH WARRANTY PARTS AND LABOR

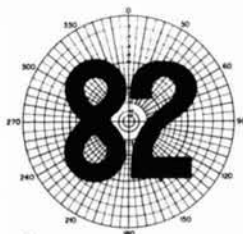

ANTENNA BOOK

14th EDITION

Now you can get the most comprehensive and up-to-date antenna data available today. It has the antenna design to fit your needs and preferences whether they be for Yagis, quads, wires, verticals, or specialized antennas such as the Beverage, curtain arrays, or special vhf/uhf applications. You'll find effective antennas for any kind of real estate from the apartment dweller to the true antenna farm. *The Antenna Book* not only provides practical antenna designs, but also gives the theory of antennas and transmission lines, including the application of Smith Charts.® Propagation phenomena are explained in detail.

The new edition will be ready for mailing in late April or early May. 328 pages, plus index. Price: \$8.00 in the U.S., Elsewhere in U.S. funds: \$8.50, at your dealer or direct from:

THE AMERICAN RADIO RELAY LEAGUE, INC.

225 MAIN STREET
NEWINGTON, CT 06111



Radio World



CENTRAL NEW YORK'S MOST COMPLETE HAM DEALER



Featuring Kenwood, Yaesu, Icom, Drake, Ten-Tec, Swan, Dentron, Alpha, Robot, MFJ, Tempo, Astron, KLM, Hy Grain, Mosley, Larsen, Cushcraft, Hustler, Mini Products, Bird, Mirage, Vibroplex, Bencher, Info-Tech, Universal Towers, Callbook, ARRL, Astatic, Shure, Collins, AEA. *We service everything we sell!*

Write or call for quote. **You Won't Be Disappointed.**

We are just a few minutes off the NYS Thruway (I-90) Exit 32

OUT OF STATE
ORDER TOLL FREE
800-448-9338

ONEIDA COUNTY AIRPORT TERMINAL BUILDING
ORISKANY, NEW YORK 13424

N.Y. Res. Call (315) 736-0184

Warren - K2IXN
Bob - WA2MSH
Al - WA2MSI

Whatever became of the apple-cheeked lad (or lass) who got their ham license before their driver's license—who was so tickled by electronics that they couldn't help but make it their career???

At Kernco we understand the care and feeding of such a career. In a small company environment we can support individual initiative, and provide access to the high technology community and academic community.

We are looking for an engineer and a design technician to help us in our development—both in our R&D Program for satellite-borne Frequency Standards and in our effort to develop related commercial products. Please call: Eric Blomberg N1BF, Chief Engineer, (617) 777-1956.



KERNCO
28 Harbor Street
Danvers, MA 01923

AZDEN only \$285.00 FREE TTKIT

■ For \$25.00 we will assemble your kit and install it in the back of your mike. **READY TO USE**. Send us your mike and TTKIT **only** and \$25.00.

If you buy **AZDEN** from us, we will install TTKIT for \$15

Order 24 hours a day — (215) 884-6010
FREE UPS - N.P.S. Inc. WA31FQ
1138 BOXWOOD RD., JENKINTOWN, PA 19046

RTTY RADIOTELETYPE FREQUENCY LISTS

2000 WORLDWIDE RADIOTELETYPE STATIONS by FREQUENCY...
press, air, military, government, diplomatic, all utilities with calls, times, plus other information 3 to 30 MHz.
\$12 POSTPAID

World Press Services
Frequencies & Manual
All press services, frequencies and transmission times. BOOK with 3 LISTS...\$8 ppd

UNIVERSAL ELECTRONICS
1280 AIDA DR. • REYNOLDSBURG, OH 43068

GOT SOMETHING TO SELL?

Try a classified ad in Amateur Radio's #1 magazine, *ham radio*.

Non-commercial ads \$.10 per word. Commercial ads \$.60 per word. No agency discounts allowed. 15% discount allowed for ads run 6 consecutive months without change. 33% discount allowed for ads run 12 months without change. Payable in advance. Deadline 15th of 2nd prior month.

From something simple to something exotic, *ham radio* readers are interested. And results prove that they BUY!

Send your ad in today. Send payment with order or give us your MasterCard or VISA and we'll charge your account for you.

Name _____

Address _____

City _____

State _____ Zip _____

Card Number _____

Expires _____ MasterCard VISA

HAM RADIO MAGAZINE
Greenville, NH 03048

flea market



RATES Noncommercial ads 10¢ per word; commercial ads 60¢ per word both payable in advance. No cash discounts or agency commissions allowed.

HAMFESTS Sponsored by non-profit organizations receive one free Flea Market ad (subject to our editing) on a space available basis only. Repeat insertions of hamfest ads pay the non-commercial rate.

COPY No special layout or arrangements available. Material should be typewritten or clearly printed (not all capitals) and must include full name and address. We reserve the right to reject unsuitable copy. Ham Radio cannot check each advertiser and thus cannot be held responsible for claims made. Liability for correctness of material limited to corrected ad in next available issue.

DEADLINE 15th of second preceding month.

SEND MATERIAL TO: Flea Market, Ham Radio, Greenville, N. H. 03048.

QSL CARDS

QSL's — BE PLEASANTLY SURPRISED! Order our three colored QSL's in all varieties for \$8.00 per 100 or \$13.00 for 200. Satisfaction guaranteed. Samples \$1.00 (refundable). Constantine Press, 1219 Ellington, Myrtle Beach, SC 29577.

QSLs & RUBBER STAMPS — Top Quality! Card Samples and Stamp Info — 50¢ — Ebbert Graphics 5R, Box 70, Westerville, Ohio 43081.

QSL CARDS: 500/\$12.50, ppd. Free catalogue. Bowman Printing, 743 Harvard, St. Louis, MO 63130.

QSL'S: No stock designs! Your art or ours; photos, originals, 50¢ for samples & details (refundable). Certified Communications, 4138 So. Ferris, Fremont, Michigan 49412.

DISTINCTIVE QSL'S — Largest selection, lowest prices, top quality photo and completely customized cards. Make your QSL's truly unique at the same cost as a standard card, and get a better return rate! Free samples, catalogue. Stamps appreciated. Stu K2RPZ Print, P.O. Box 412, Rocky Point, NY 11778 (516) 744-6260.

Foreign Subscription Agents for Ham Radio Magazine

Ham Radio Austria
F. Bastei
Hauptplatz 5
A-2700 Wiener Neustadt
Austria

Ham Radio Belgium
Stereohouse
Brussels/Steinweg 416
B-9218 Gent
Belgium

Ham Radio Canada
Box 400, Goderich
Ontario, Canada N7A 4C7

Ham Radio Europe
Box 444
S-194 04 Upplands Vasby
Sweden

Ham Radio France
SM Electronic
20 bis, Ave des Clairons
F-89000 Auxerre
France

Ham Radio Germany
Karin Ueber
Postfach 2454
D-7850 Loerrach
West Germany

Ham Radio Holland
Postbus 413
NL-7800 Ar Emmen
Holland

Ham Radio Italy
G. Vulpetti
P.O. Box 37
I-22063 Cantu
Italy

Ham Radio Switzerland
Karin Ueber
Postfach 2454
D-7850 Loerrach
West Germany

Ham Radio UK
P.O. Box 63, Harrow
Middlesex HA3 6HS
England

Holland Radio
143 Greenway
Greenside, Johannesburg
Republic of South Africa

CADILLAC OF QSL CARDS, 3 to 4 colors, send \$1 for samples (Refundable). Mac's Shack, P.O. Box 43175, Seven Points, TX 75143.

QSL ECONOMY: 1000 for \$13. SASE for samples. W4TG, Box F, Gray, GA 31032.

HEATHKIT HW-101, very good condition with power supply, speaker, microphone, CW filter and manual. \$375/offer, 1 ship. N9CFI, 12336 W. Holt, West Allis, Wis. 53227.

MOBILE OPERATORS: Anteck's Mobile Antennas cover 3.2 to 30 MHz inclusive, with no coil changing. 50 Ohms input. Two models, the MT-1 MANUAL, MT-1RT REMOTE-TUNED from the operators position. Uses two Hyd. Pumps and Motors. MT-1 \$129.95, MT-1RT \$240.00 plus UPS postage. Check your local dealer or write for Dealer List and Brochure. ANTECK, INC., Route One, Box 415, Hansen, ID 83334. 208-423-4100.

RTTY AND ASCII for your Atari Computer: Modem, personalized program and manual to get your Atari on ASCII & RTTY. \$125. 16K and Atari 850 interface required. You must include your name, QTH and call sign. Write: Robert Holst, K7ZJD/KH2, POB 4426, AAFB Br., Yigo, Guam 96912.

WANTED: Micor and Mstr II Base Stations 406-420 and 450-470 MHz. Also 2 and 6 GHz solid state microwave equipment. AK7B, 4 Ajax Place, Berkeley, CA 94708.

WANTED FOR PARTS: Royce 1-612 CB transceiver, phase lock loop box must be working. Emil Polashek, 117 E. Third St., Cresco, Iowa 52136.

AMP-LETTER: Devoted to designing, building, and operating Amateur Radio Amplifiers. Sample \$2.00. AMP-LETTER, RR2 Box 39A, Thompsonville, IL 62890.

SPRING CLEANUP — Commercial tower, 150 feet, suitable for large Amateur arrays, broadcasting or TV, with guys and insulators, recently removed from service, pictures on request. Heath HW101 transceiver, PS23B, MFJ Grandmaster memory keyer and 520 BX speech processor. All guaranteed A1 working condition. Renwick, P.O. Box 50, Clavet, Sask., Canada, S0K 0Y0. (306) 373-1988.

TUBES, TUBES wanted for cash or trade. 304TL, 4CX1000A, 4PR60C, 7F7, 7N7, 53, 6L6M. Any high power or special purpose tubes of Eimac/Varian. DCO, 10 Schuyler Avenue, No. Arlington, NJ 07032. (800) 526-1270.

WANTED: Hammerlund HQ145. Call Arnie (212) 925-6048.

HAM RADIO FANATICS! You need the W5YI Report — Twice monthly award-winning insider newsletter. 24 issues — \$18.00. Sample issue SASE (2 stamps). W5YI, Box #10101-H, Dallas, Texas 75207.

ATLAS 350XL, DD6XL, AUXVFO305 \$850. Icom IC211 \$450. SASE for list. K4TO, Dave Sublette, 1207 Monte Sano Blvd., Huntsville, AL 35801.

ATLAS DD6-C Digital Dial \$120.00 plus \$4.00 UPS. NEW, while they last. Mical Devices, P.O. Box 343, Vista, CA 92083.

BUY-SELL-TRADE. Send \$1.00 for catalog. Give name, address and call letters. Complete stock of major brands new and reconditioned Amateur Radio equipment. Call for best deals. We buy Collins, Drake, Swan, etc. Associated Radio, 8012 Conser, Overland Park, KS 66204. 913-381-5900.

CONNECTICUT'S Ham Store — Rogus Electronics, 250 Meriden-Waterbury Turnpike, (Rt. 66) Southington. (203) 621-2252.

RTTY FOR SALE: Several machines remaining. Model 15, Model 19, 28RO w/gearshift, p.s. for ROBOT 800, deluxe 34ASR, 28KSR, 28 keyboard typing reperf, 28TD's, 33KSR, 33ASR, 35KSR, several demodulators, video RTTY. Model 28 gearshifts, parts and supplies. Send SASE for complete list and prices. Lawrence R. Pfeiffer, K9WJB, 2600 S. 14th Street, St. Cloud, MN 56301. Phone (612) 255-9794.

ELF II with Giant Board, 8K memory, terminal, complete software package and manuals. \$400. Steven Powell, 12607 Wellington Park, Houston, TX 77072 (713) 495-0488.

MANUALS for most ham gear made 1937/1970. Send \$1.00 for 18 page "Manual List", postpaid. HI-MANUALS, Box R802, Council Bluffs, Iowa 51502.

FOR SALE: TRS-80 model III, 16k computer and accessories. \$900.00. Phone: 626-0402. Jim Bellini, 1005 Arland St., Rock Falls, IL 61071.

DON'T GET STRANDED! Battery Watchdog's alarm informs you of excess power drain. \$19.95. J.F. Ratcliff, 3600 Meadow N., Renton, WA 98056. SASE brochure.

ISOTRON ANTENNAS

THE BEST THINGS
come in little packages...

FOR 80-40-20 METERS

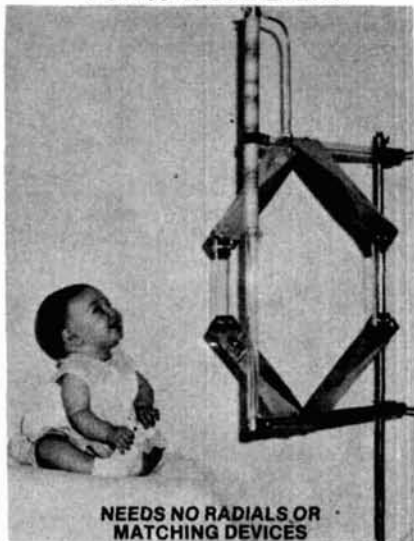

NEEDS NO RADIALS OR
MATCHING DEVICES

ISOTRON 80 54 IN. HIGH ISOTRON 40 31 IN. HIGH ISOTRON 20 17 IN. HIGH

BIG ON PERFORMANCE

SMALL ON SPACE

BILAL COMPANY

(303) 687-3219

STAR ROUTE

FLORISSANT CO 80816

GLB HIGH PERFORMANCE PRESELECTORS

MODEL P50 to P500



- 50 - 500 MHz
- Ultimate rejection over 80 dB
- Five large helical resonators
- Low noise
- High overload resistance
- Typical rejection figures:
± 600 kHz at 144 MHz: -30 dB
± 1.6 MHz at 220 MHz: -40 dB
± 5 MHz at 450 MHz: -45 dB
- The solution to interference, intermod and desens problems on repeaters
- 12V DC operation
- Dimensions only 1.6 x 2.6 x 4.75 excluding connectors
- Custom tuned to your frequency
- Low cost — only \$69.95
- Allow \$2.00 for shipping and handling

We have a complete line of transmitter and receiver strips and synthesizers for Amateur and commercial use. Write or call for our free catalog.

We welcome MasterCard or VISA

GLB ELECTRONICS

1952 Clinton St., Buffalo, N. Y. 14206

1-(716) 824-7936, 9 to 4

Power Line Filters

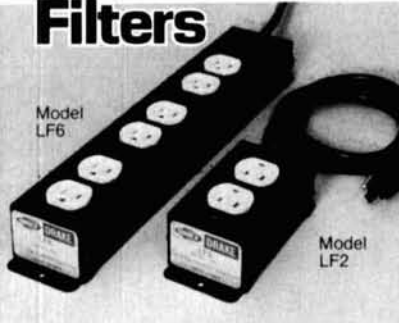

These filters protect any sensitive electronic equipment from power line transient damage and radio frequency interference. Both models offer common mode and differential mode surge suppression for power line "spikes". Rf interference is suppressed using both inductive and capacitive components. Ideal for computers, test equipment or TV.

LF2 a duplex outlet, 120V, 8 amps max... **\$39.95**
LF6 three separately filtered duplex outlets, 120 V, total fused capacity 15 amps, power switch and indicator lamp... **\$59.95**
 Add **\$2.50** shipping and handling per order.

Send check with order and provide street address for UPS shipment. Ohio residents add Sales Tax. Charge card buyers may call toll free:

1-800-543-5612



In Ohio, or for information call:
1-513-866-2421

R. L. DRAKE COMPANY

540 Richard Street, Miamisburg, Ohio 45342

INSTITUTIONAL AND DEALER INQUIRIES INVITED



Super
 Specials

NEMAL ELECTRONICS COAXIAL CABLE SALE

POLYETHYLENE DIELECTRIC

RG213 noncontaminating 96% shield mil spec 36"/ft.
 RG214/U double silver shield 50 ohm \$1.35/ft.
 RG62U 93 ohms 10"/ft.
 RG11U 96% shield 75 ohm mil spec 25"/ft.
 *RG-8/U 96% shield Mil Spec (\$23.95/100) or 31"/ft.
 RG6A/U double shield 75 ohm 25"/ft.
 RG-55B/U double shield (RG-58 size) 50 ohm 50"/ft.
 RG58U mil spec 96% shield 11"/ft.

LOW LOSS FOAM DIELECTRIC

*RG-8X (Mini 8) 95% shield (\$14.95/100) or 17"/ft.
 RGR8U 80% shield 18"/ft.
 RG-8/U 97% shield 11 gauge (equiv. Belden 8214) 30"/ft.
 RG58U 80% shield 07"/ft.
 RG58U 95% shield 10"/ft.
 RG59/U 100% foil shield TV type 07"/ft.
 Rotor cable 2-18 ga 6-22 ga 19"/ft.

CONNECTORS MADE IN USA

Amphenol PL 259 79¢
 PL-259 push-on adapter shell 10/\$3.89
 PL-259 & SO-239 10/\$5.89
 Double Male Connector \$1.79
 PL-258 Double Female Connector 98¢
 1 ft. patch cord w/RCA type plugs each end 3/\$1.09
 Reducer UG-175 or 176 10/\$1.99
 UG-255 (PL-259 to BNC) \$3.50
 Elbow (M359) UHF Elbow \$1.79
 F59A (TV type) 10/\$1.99
 UG 21/U Type N Male for RG8, Amphenol \$3.00
 UG-88C/U BNC Male for RG-58, Amphenol \$1.25
 Double Female N Chassis Mt. UG-30 \$4.75
 3/16 inch Mike Plug for Collins etc. \$1.25

Call or write for Free Catalog

shipping

Cable — \$3.00 1st 100 ft., \$2.00 each add'l 100 ft.
 Connectors — add 10%, \$2.50 minimum.
 COD add \$1.50. Florida Residents add 4%.

NEMAL ELECTRONICS

5685 SW 80th St., Dept. H, Miami, FL 33143
 Telephone: (305) 661-5534

WANTED: Surplus 1-3 kW HF transmitter type FRT-15, Collins TDH or equivalent, or higher power up to 20kW SSB not necessary. P.J. Plishner, 2 Lake Ave. Ext., Danbury, CT 06810. WA1LDU.

RTTY JOURNAL-EXCLUSIVELY AMATEUR RADIOTELETYPE, one year subscription \$7.00. Beginners RTTY Handbook \$5.00, RTTY Index \$1.50. P.O. Box RY, Cardiff, CA 92007.

HARDWARE/SOFTWARE subassembly provides Morse-ASCII conversion without any manual adjustments. Many extras. \$169 bargain. Telecraft Laboratories, Box 1185, E. Dennis, Mass. 02641.

CUSTOM EMBROIDERED EMBLEMS — Your design, low minimum. Informational booklet. Emblems, Dept 65, Littleton, New Hampshire 03561. (603) 444-3423.

PACKET RADIO — Start a network with our hardware and free software using HDLC, ASCII. Smart terminal controller pcb \$30, parts \$112. 1200 baud radio modem pcb \$15, tested \$70. Newsletter \$10. VADCG, 818 Rondeau St., Coquitlam, B.C., Canada V3J 5Z3.

OUR KEYERS turn difficult DX into logged contacts. SASE for information. Webco, Box 740211, Houston, Texas 77274.

SELL: 4-NB noise blander from Drake R4C, \$30 postpaid. HQ-180C and speaker \$225. Much high-power gear. M.E. Coombs, 839 West M, Springfield, Oregon 97477.

WANTED: Pre-1950 TV sets and old TV Guides. Jeff Kadet, W3CRH, Box 90-HR, Rockville, MD 20850. (301) 654-1876.

SINCLAIR RADIO LABS MR-344B four cavity 450 MHz duplexers. Mint condition, \$25. Alan Brown, K5MW, Route 4, Box 200-A, College Station, Texas 77840.

TRYING TO CONTACT present and retired employees of the E.I. DuPont de Nemours Company of Wilmington, Delaware. A DuPont Employees Callbook is being researched with publication expected in June 1982. Write to O.R. Averitt, Building 357, DuPont Experimental Station, Wilmington, Delaware 19898 for information.

WANTED: Early Hallicrafter "Skyriders" and "Super Skyriders" with silver panels, also "Skyrider Commercial", early transmitters such as HT-1, HT-3, HT-19, and other Hallicrafter gear, parts, accessories, manuals. Chuck Dachis, WD5EOG, The Hallicrafter Collector, 4500 Russell Drive, Austin, Texas 78745.

ROHN TOWERS — Wholesale direct to users — all products available — write or call for price list. Also we are wholesale distributors for Antenna Specialists and Regency FM radios — Hill Radio, P.O. Box 1405 — 2503 GE Rd., Bloomington, IL 61701. (309) 663-2141.

YAESU OWNERS: Join your International Fox-Tango Club, now in its eleventh year. Calendar year dues still only \$8 US, \$9 Canada, \$12 airmail elsewhere. Don't miss out, get 1982 top-rated FT Newsletters packed with modifications monthly, catalog of past modifications, free advertisements, technical consultation, FT net (Saturdays, 1700Z, 14.325 MHz), more. Go Fox-Tango! To join, send dues to FT Club, Box 15944, W. Palm Beach, FL 33406.

SALE NEW FRG-7 in factory sealed carton for \$250 including shipping and original invoice dated Feb. 1982. Roy Merkel, W3HPP, 959 Georges Lane, Warminster, PA 18974. (215) 675-5864.

HAM RADIO REPAIR, experienced, reasonable, commercial licensed. Robert Hall Electronics, P.O. Box 8363, San Francisco, CA 94128. W6BSH, (408) 292-6000.

FOR SALE: Yaesu FT101E with digital display YC601 — together with DenTron linear MLA 2500. Best offer — all guaranteed perfect condition — on air every morning 3990 KC. Tel 1-401-789-1817. W1CPI.

RUBBER STAMPS: 3 lines \$3.25 PPD. Send check or MO to G.L. Pierce, 5521 Birkdale Way, San Diego, CA 92117. SASE brings information.

HAM-AD-FEST™ — Next 6 issues, \$2.00. WA4OSR, Box 973, Mobile, AL 36601.

MOBILE IGNITION SHIELDING provides more range with no noise. Available most engines. Many other suppression accessories. Literature, Estes Engineering, 930 Marine Dr., Port Angeles, WA 98362.

SAFETY BELTS. \$35.00 and up. Free information. Avatar Co., (W9JVF) 1147 - (H) N. Emerson, Indianapolis, IN 46219.

CONTESTERS: Package of programs designed for the ARRL DX, CQWW, CQWPX and IARU Radio Sport Contests produces scored, duped log, dupe sheet, QSLs and many valuable operator statistics. TRS-80 Model 1, 48k, 1 or more discs, MX-80 printer required. \$69.95 plus tax non-refundable. Sample printout with SASE. P. Chamaian, W1RM, P.O. Box 1188, Burlington, CT 06013.



July 31 thru August 13, 1982

Our 23rd year

Have trouble finding time to study for Upgrading? Do it on your vacation at the

OAK HILL ACADEMY RADIO SESSION in the Blue Ridge Mountains of Virginia

Two weeks of intensive Code and Theory Study starting at your level.

- Novice to General
- General or Technician to Advanced
- Advanced to Amateur Extra

Expert Instructors — Friendly Surroundings — Excellent Accommodations.

Ham Lab set up for all to use.

"A Vacation with a Purpose"

C. L. PETERS, K4DNJ, Director
 Oak Hill Academy Amateur Radio Session
 P. O. Box 1461, N. Myrtle Beach, SC 29582
 (803) 272-6428

Name _____ Call _____
 Address _____
 City/State/Zip _____



CONNECTORS BNC TYPE

UG-260/U (BNC Male for RG 59/U) \$1.25
 UG-88/U (BNC Male for RG 58/U) \$1.25
 UG-274/U (BNC "T") \$3.00
 UG-306/U (BNC-90) \$3.00
 UG-255/U (BNC Male to UHF Female) \$2.95
 UG-273/U (BNC Female to UHF Male) \$2.25
 UG-1094/U (BNC Chassis Mount) 79¢
 UG-914/U (BNC Female to BNC Female) \$1.69

"N" TYPE

UG-21/BU (Male for RG-8/U) \$2.75
 UG-23/BU (Female for RG-8/U) \$2.85
 UG-58/AU (Chassis Mount) \$2.25
 UG-57/BU (Double Male) \$4.25

Special Wholesale Prices Quoted To
 Accredited Dealers

FREE CATALOG - Minimum Order \$25.00
 55 RAILROAD AVE., GARNERVILLE, N.Y. 10923
 Dealer Inquiries Invited

(914) 947-1554

SAY
 YOU SAW
 IT IN
 ham radio!

Tell 'em you saw it in HAM RADIO!

GEM-QUAD FIBRE-GLASS
ANTENNA FOR 10, 15, and 20 METERS

Two Elements \$215.00
Extra Elements \$154.00
Price is F.O.B. Transcona
INCLUDES U.S. Customs Duty

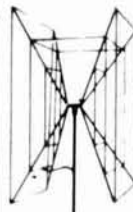

KIT COMPLETE WITH
*SPIDER
*ARMS
*WIRE
*BALUN KIT
*BOOM WHERE NEEDED

WINNER OF MANITOBA
DESIGN INSTITUTE
AWARD OF EXCELLENCE

Buy two elements now — a third and fourth may be added later with little effort.

Enjoy up to 8 db forward gain on DX, with a 25 db back to front ratio and excellent side discrimination.

Ask for our new 2m Quad Kit when you order your Gem Quad. It's FREE for the asking!

Get maximum structural strength with low weight, using our "Tridetic" arms. Please inquire directly to:

GEM QUAD PRODUCTS LTD.
Box 53
Transcona Manitoba
Canada R2C 2Z5
Tel. (204) 866-3338

OVERPRINTED — 1981 Fox-Tango Club Newsletters. Sixty loose-leaf pages packed with modifications and information on Yaesu rigs. Only \$6 while they last. Also a few 1980 sets at \$5. (Overseas add \$3 each, airmail.) N4ML, Box 15944, W. Palm Beach, FL 33406.

HAM RADIO OPERATORS who are owners of Atari Micro-Computer systems. Join the Atari Micro-computer net to exchange ideas on applications, programming, hardware and software development. Please contact Jack McKirgan II, WD8BNG, 4749 S.R. 207 N.E., Washington C.H., Ohio 43160. (614) 869-3597.

SALE — HW-16 \$125 (w/crystals \$150). 2 Johnson match-box tuners, best \$50, other (needs repair) \$25. Heath 2 meter mobile amp \$30. 10-40 vertical \$25. You pay shipping. KA4EBW, Jim Howell, 18 Dan Street, Salisbury, NC 28144.

SATELLITE TELEVISION: Information on building or buying your earth station. Six pages of what's needed, where to get it, etc. \$4.00 to Satellite Television, RD #3, Oxford, NY 13830. Parabolic antenna construction book also available. Send SASE for details.

WANTED: New or used MS and coaxial connectors, synchros, tubes, components, military surplus equipment. Bill Williams, PO #7057, Norfolk, VA 23509.

MAKE HAM RADIO FUN! Supplement your learning programs with a motivational hypnosis cassette. Tape #3, Learning the Code; Tape #4, Breaking the Speed Barrier; Tape #7, Electronic Theory. Free catalog. For tapes, \$10.95 each to Gem Publishing, 3306 North 6th St., Coeur d'Alene, ID 83814.

CORDLESS TELEPHONES — Low prices, all major brands. Inquiries or Visa/MasterCard orders call (206) 743-3977 or Write Trinetics, Box 6005, Lynnwood, WA 98036.

VERY in-ter-est-ing! Next 5 issues \$2. Ham Trader "Yellow Sheets", POB356, Wheaton, IL 60187.

MICROWAVE CONVERTERS, decoders. Catalog 20¢. G.W. Electronics, P.O. Box 688, Greenwood, Indiana 46142.

CB TO 10 METER PROFESSIONALS: Your rig or buy ours — AM/SSB/CW. Certified Communications, 4138 So. Ferris, Fremont, Michigan 49412; (616) 924-4561.

AFC SEMI-KITS! Stop VFO drift. See June 1979 HR. \$55.00 plus \$3.00 UPS. Mical Devices, P.O. Box 343, Vista, CA 92083.

HAMS FOR CHRIST — Reach other Hams with a Gospel Tract sure to please. Clyde Stanfield, WA6HEG, 1570 N. Albright, Upland, CA 91786.

PURPLE HEART VETERANS: Organizing national Amateur Radio Chapter and Net to be affiliated with Military Order of the Purple Heart, Inc. For information and applications contact Clem Harris, KC5MM (ex WB5VDL), 6110 Pecan Trail Dr., San Antonio, TX 78249. (512) 699-1420.

Coming Events
ACTIVITIES
"Places to go..."

ALASKA: The Arctic Amateur Radio Club of Fairbanks will hold a Hamfest, June 5, Kiwanis AG Hall, Tanana Valley Fairgrounds. Doors open 8 AM. \$5 sellers' fee. There will be a Left Footed Key for a code contest ending at 5 PM for a pot luck dinner. Also ARRL representatives and Alaska QSL Bureau will be there. For information: Herb Walls, KL7JLF, P.O. Box 1625, Fairbanks, AK 99707.

ARKANSAS: The Northwest Arkansas Amateur Radio Club's 2nd annual Hamfest/Swapmeet, Saturday, May 15, Community Building, Rogers on US Hwy. 71. 8 AM to 4 PM. Commercial exhibitors and flea market tables/space FREE. Doors open 8 AM. Main prizes include a complete Kenwood station, Icom IC2AT hand-held, Diawa Model 720 cross-needle SWR/power meter. Door prizes. Free parking. MARS, DX and Skywarn. Talk-in on 146.16/.76 or 146.52 simplex. Main prize tickets 3/\$5.00 or \$2.00 each. For information: Mary Webb, KA5HEV, P.O. Box 338, Prairie Grove, AR 72753. (501) 846-2847.

CALIFORNIA: The Fresno Amateur Radio Club's 40th annual Hamfest, May 21, 22 and 23, Hacienda Inn, Clinton and Highway 99, Fresno. Activities include a golf tournament, swap tables, CW contest, MARS meetings, transmitter hunt, cocktail hour, banquet. Talk-in on 146.34/93. Advance registration \$20.00. For information/registration: Fresno Amateur Radio Club, Inc., P.O. Box 783, Fresno, CA 93712.

KENWOOD

\$SAVES\$
\$CALL TOLL FREE\$



TS530S



SEE KENWOOD
CENTERSPREAD
USE BONUS BUCK
COUPON AND SAVE!!!



TR7730



THE COMM CENTER 20810 INC.
Laurel Plaza
Route 198
Laurel, Md.
MD.: 301-792-0600
OPEN TUES. THROUGH SAT.

CALL TOLL FREE
1-800-638-4486

THEY TALK

Spies ...
Smugglers ...
Pirate Stations ...
Secret Police ...
Foreign Agents ...



YOU LISTEN

★ Miniature Active Antennas
★ Scanner Signal Boosters
★ Frequency Converters
★ Frequency Lists
★ Antenna Tuners
★ Code Breakers

■ Low cost
■ Fully guaranteed

GROVE **FREE CATALOG**
For more information write:
GROVE ENTERPRISES
Department D
Brasstown, N.C. 28902

FCC STUDY GUIDE — RADIO TELEPHONE OPERATOR LICENSE

IT'S AMAZING HOW EASY FCC EXAMS REALLY ARE!



The Original Tests-Answers Exam manual prepares you at home for FCC Radio telephone licenses. You get the complete set of multiple-choice examinations—covering all areas tested on the actual FCC exam. Also included—helpful study tips, short cuts, and "Self-Study Ability Test." These updated FCC Tests-Answers take the mystery out of preparing for current FCC exams. Practical proven Material. \$12.95 postpaid.

SEND TO:

HAM RADIO'S BOOKSTORE
Greenville, NH 03048

Please rush me Tests-Answers for FCC License. My \$12.95 is enclosed.

Name _____
Address _____
City _____ State _____ Zip _____

Call 603-878-1441



CERTIFIED INTERNATIONAL

NO HUGE AD—JUST SAVINGS FOR YOU
ON

CUSHCRAFT, HUSTLER, LARSEN, UNADILLA, BELDEN,
COPPERWELD, SIGNALCRAFTER, PALOMAR, NYE VIKING,
TRIONYX, TRAC, JANEL, BENCHER, VIBROPLEX,
AMPHENOL, GOULD, DURACELL, WELLER AND OTHERS.

QSL'S CUSTOM MADE ALL CRYSTALS from \$4.00

CB to 10 Meter Conversions
by **CERTIFIED COMMUNICATIONS**

your rig from \$45. New from us from \$179

SEE US AT OVER 70 SHOWS A YEAR. CALL OR WRITE FOR QUOTE,
CATALOG, INFORMATION, QSL SAMPLES (50 cents)

CALL COLLECT TO ORDER

ITS WORTH YOUR WHILE TO CHECK WITH US!

SEE YOU AT GREENVILLE, ROCHESTER, KNOXVILLE,
CADILLAC, MINNEAPOLIS and OTHERS

CERTIFIED INTERNATIONAL

4138 South Fern, Greenville, NH 03048 (603) 878-1441

ATTENTION DEALERS!

Interested in
making a PROFIT?

Sell our magazine in
your store with
100% Return Privileges

Rose will tell
you how —

CALL 1-603-878-1441

**The Ham Radio
Publishing Group**
Greenville, NH 03048

COLORADO: The Rocky Mountain VHF Society's annual spring Hamfest, Sunday, May 23, 9 AM to 3 PM, rain or shine, Boulder National Guard Armory, 4750 North Broadway. Donation \$2 per family. Gates open for sellers 8 AM. Bring own tables. Door prizes include synthesized FM transceiver. Extra raffle tickets available. Refreshments available. Talk-in on 146.16/76 and 146.52. For information: Richard Ferguson, KA0DXM, 1150 Albion Rd., Boulder, CO 80303. (303) 499-2871.

COLORADO: SUPERFEST 4 sponsored by the Northern Colorado Amateur Radio Club, June 5, 8 AM to 4:30 PM, McMillen Building, Larimer County Fairgrounds, Loveland. \$3 admission includes swap table. Exhibits, tech talks, code contest with prizes, auction, swapfest, prize drawings including a synthesized 2-meter hand-held. Food service, free parking. Special activities for non-Hams and kids. For information: Gene Bellamy, WD0DRM, 3124 West 6th Street, Greeley, CO.

GEORGIA: The Anderson, Hartwell and Toccoa Amateur Radio Clubs' 4th annual Lake Hartwell Hamfest, May 22 and 23, Lake Hartwell Group Camp, Highway 29. Free admission, free camping (campground opens 6 PM Friday) free flea market space. Bingo, horsehoes, a left-footed CW contest and other activities for the whole family. Fishing, swimming on site. Main prize drawing 2 PM Sunday. Talk-in on 146.19/79, 147.93/33 and 146.895/295. For information: Ray Pettit, WB4ZLG, Rt. #1 Dooley Drive, Toccoa, GA 30577.

IDAHO: The Kootenai Amateur Radio Society's Hamfest '82, Saturday, June 12, 8 AM to 4 PM, Kootenai County Fairgrounds, north of Coeur D'Alene on old Highway 95. Prizes, flea market, food available. No pre-registration, free tables available. Talk-in on 38/98. For information: SASE to Avon Anderson, WB7WBZ, N. 1035 Highland Ct., Post Falls, ID 83854.

ILLINOIS: The Illiana Repeater System's 13th annual Danville Area Hamfest, May 23, Georgetown Fairgrounds. Flea market, forums, family entertainment, free parking. Many prizes. Gates open 6 AM. Tickets \$2.50 advance, \$3.00 gate. Talk-in on 22/82 and 146.52. For information, tickets, tables: Wendell Lyons, KA9AYS, Hamfest Chairman, 930 Polk St., Danville, IL 61832. (217) 431-2124.

INDIANA: The Tristate Amateur Radio Society's annual Hamfest, Sunday, May 16, Vanderburgh County 4H Center, Evansville. Grounds open 6 AM. Admission \$2. Outdoor flea market. Indoor tables available. Talk-in on 147.75/15 and 146.19/79. For information/table reservations: Hal Wilson, WB9FNN, R.R. #8, Box 427B, Evansville, IN 47711.

INDIANA: The 3rd annual MAARC (Muncie Area Amateur Radio Club) Hamfest, May 23, 8 AM to 3 PM, Ball State University indoor track building, Muncie. Prizes, forums, refreshments, parking. Flea market tables \$4.00. Talk-in on 146.13/73, 146.52, 223.10/224.70. Tickets \$2.00 advance; \$3.00 door. For information: Terry Evans, WD9HQH, 522 S. Brotherton, Muncie, IN 47302. (317) 282-0615.

INDIANA: The Wabash County ARC's 13th annual Hamfest, Sunday, May 16, 5 AM to 4 PM, Wabash County 4-H Fairgrounds, Wabash. Admission \$2.50 advance; \$3.00 gate. Plenty of food and parking available. Free overnight camping Saturday. Talk-in on 147.63/03 or 146.52 simplex. For information/tickets SASE to Dave Spangler, N9ADO, 45 Grant St., Wabash, IN 46992.

KANSAS: The Chippewa Amateur Radio Club is having its 20th annual Hamfest, May 23, at Garnett North Lake, Garnett. For information: Reid Richardson, 518 West 7th, Garnett, KS 66032.

KENTUCKY: The N.K.A.R.C.'s annual HAM-A-RAMA, Sunday, May 23, Burlington Fairgrounds, Burlington, off 2-75 Florence exit. Tickets \$4.00 each; family ticket \$6.00. Each ticket entitles you to major prize drawing at 4 PM. First prize: Kenwood TS-130S or \$500.00. Second prize: Kenwood HC-10 station clock. Special raffle for Icom 2AT. Door prizes every hour. Indoor vendors, flea market, refreshments. Talk-in on 146.19/79 and 147.86/26. For information — Jack R. Thompson, 637 Wolf Rd., Covington, KY 41015 or call (606) 291-2153.

MAINE: The Portland Amateur Wireless Association and the Southern Maine University Radio Club will hold their annual Flea Market, May 22, Gorham, Maine campus. 8 AM to 4 PM. Admission \$1.00. Food available. If raining, will be held inside. Talk-in on 146.73R and 146.52S. For information: John Taylor, N1SD, (207) 773-2651.

MARYLAND: The eighth annual Easton Amateur Radio Society's Hamfest, May 16, rain or shine, 8 AM to 4 PM, Easton Senior High School. Donation \$2.00 plus \$2.00 for tables or tailgaters. Talk-in on 52 simplex and 146.445/147.045 repeater in Easton. Van Herridge, WB3HQG, Box J, St. Michaels, MD 21663 or Easton ARS, Box 781, Easton, MD 21601.

MARYLAND: The Maryland FM Association's annual Hamfest, Sunday, May 30, Howard County Fairgrounds, West Friendship, 8 AM to 4 PM. Donation \$3.00. Tail-

Confidential Frequency List

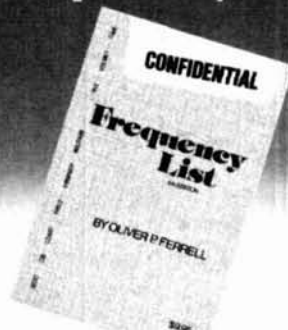

New 5th edition by Perry Ferrell

Bigger and better than the world-acclaimed 4th edition, this new book has 30% more stations listed, more than 7500 operating between the international broadcasting and amateur radio bands, spanning 4-28 MHz. Listings by both frequency and call sign reflect present and post-WARC assignments. Complete list of Coastal CW stations plus Embassy, Aeronautical, Military, Time Sigs, Feeders, VOLMET, FAX, INTERPOL, etc. New details on scheds, emergency channels, alternates, and never-before-published IDs.

In USA: \$9.95 Book Mail, or \$12.00 UPS. Outside USA: Book Mail US\$11.00.

Overseas Airmail: US\$14.00 + US\$3.30 Registration to assure delivery.

GILFER SHORTWAVE
Dept. H5, Box 239, Park Ridge NJ 07656

MOVING? KEEP HAM RADIO COMING ...

If possible let us know four to six weeks before you move and we will make sure your HAM RADIO Magazine arrives on schedule. Just remove the mailing label from this magazine and affix below. Then complete your new address (or any other corrections) in the space provided and we'll take care of the rest.

**ham
radio**
Magazine

Allow 4-6 weeks for correction.

Greenville, NH 03048

Thanks for helping us to serve you better.

Here's my new address:

Call _____

Name _____

Address _____

City _____ State _____ Zip _____

**AFFIX
LABEL
HERE**

RADIO WAREHOUSE

SPRING CLEANING SALE



TS-830S
\$839⁹⁵



FT-101ZD
\$789⁹⁵

TR-7730/TTM \$299.95
IC-25A \$299.95
FT-208R \$299.95
IC-4AT \$264.95



TR-9130 \$479⁹⁵

Get **THEIR** lowest price
THEN CALL US!

P.O. BOX 2728
DALLAS, TX 75221

Telephone: (817) 496-9000

Alaska Microwave Labs

4335 EAST FIFTH STREET ANCHORAGE
ALASKA 99504 (907) 338-0340 DEPT HR

<p>USE BATTERY OR RECHARGEABLE BATTERIES Capacitors \$1.99 Cap Capacitors 60¢</p> <p>TRANSISTORS</p> <p>MPF 301 \$3.00 MPF 301 1/2 \$3.00 MPF 301 1/2 \$3.00 MPF 301 1/2 \$3.00 NEC 0737 \$3.25 NEC 0735 \$3.00 NEC 0635 \$3.00</p> <p>IC'S</p> <p>MWA-110 \$8.75 MWA-120 \$8.75 MWA-130 \$10.00 MWA-150 \$10.00 NEC MC 4471 \$13.50 NEC 4471 \$13.50 NEC 4471 \$13.50 MC 1348 (8 1/2) \$2.50</p> <p>FERRITE ISOLATORS</p> <p>RF CABLE</p> <p>HOT CARRIER DIODES</p> <p>MWD 10 \$1.50 MWD 10 \$1.50 MWD 10 \$1.50</p> <p>PISTON TRIMMERS</p>	<p>GAS TETS</p> <p>MGE 1100 \$13.00 MGE 112 \$14.00 MGE 1200 \$14.00</p> <p>CAPACITORS</p> <p>500P 50V \$0.1 1000P 50V \$0.1 1000P 100V \$0.1 1000P 250V \$0.1</p> <p>COAX CONNECTORS</p> <p>SWR 1/2" \$1.95 SWR 3/8" \$1.95 SWR 1/4" \$1.95 SWR 1/8" \$1.95 SWR 1/16" \$1.95 SWR 1/32" \$1.95 SWR 1/64" \$1.95 SWR 1/128" \$1.95</p> <p>DUAL GATE MOSFET</p> <p>NEC 4471 \$13.50</p> <p>SILVER PLATING</p> <p>MIXERS</p> <p>V72-T1 \$98.00 V72-T2 \$98.00 V72-T3 \$98.00 V72-T4 \$98.00 V72-T5 \$98.00 V72-T6 \$98.00 V72-T7 \$98.00 V72-T8 \$98.00 V72-T9 \$98.00 V72-T10 \$98.00</p>
---	---

OPEN AT 8PM EST CLOSED 8PM PST
ORDERS ARE POSTAGE PAID
COD-VISA-MASTERCHARGE
IF YOU DO NOT SEE
WHAT YOU WANT ASK

gating \$3.00. Advance tables \$6.00 each. Limited quantity at door \$10.00 each. Talk-in on 146.16/76 and 52. For information: MFMA Hamfest Committee, PO, Harman's, MD 21077. For Table info/reservations: John Elgin, WA3MNN, 5495 Apt. 2, Harpers Farm Road, Columbia, MD 21044. (301) 596-3741.

MASSACHUSETTS: The South Shore Repeater Association's annual Ham Radio/Electronic/Computer Flea market, Saturday, May 22, Weymouth South High School Cafeteria, 300 Pleasant Street, Weymouth. Doors open for sellers 9 AM, buyers 10 AM. Admission \$1 each buyer. Tables \$5 advance; \$8 as available at door. Refreshments available. All proceeds support the 147.90/30 Weymouth Repeater. For information/advance tables: SSRA, David Newman, P.O. Box 447, Abington, MA 02351.

MASSACHUSETTS: The Hampden County Radio Association's annual Flea Market, Feeding Hills Congregational Church, Rts. 57 and 187, Feeding Hills, May 7, 8 PM. Talk-in on 146.34/94. For information: Larry Langevin, K1GXU, (413) 583-8236.

MASSACHUSETTS: The eighth annual Eastern VHF/UHF Conference, May 14-16, Sheraton Inn and Conference Center, Foxboro. Activities of interest to the serious VHFers, Friday night hospitality room. Saturday night banquet, featuring roast sirloin of beef, \$14.00 before May 10. Registration \$13.50 to K1LOG, Rick Commo, 3 Pryor Rd., Natick, MA 01760 before May 10. Door registration \$20.00.

MICHIGAN: The Central Michigan Amateur Repeater Association's eighth annual Hamfest, June 12, Valley Plaza Complex, off Rt. 10, Midland. 8 AM to 4 PM. Donation \$3.00. Children under 12 free. Tables \$6.00; trunk sales \$2.00. Free parking. Hourly prize drawings. Major prize drawing 2:30. Talk-in on 146.67/07 and 146.52 simplex. Motels, RV hookups, swimming, dining, bowling alley, theaters, picnic area at Hamfest location. For information: Carol Hall, WD8DQG, 4651 Cardinal Dr., Mt. Pleasant, MI 48858. (517) 772-0363.

MICHIGAN: The Chelsea Swap and Shop, Sunday, June 6, Chelsea Fairgrounds, Chelsea. Gates open for sellers 5 AM; public 8 AM to 2 PM. Advance donation \$2.00; \$2.50 gate. Children and non-ham spouses admitted free. Talk-in on 146.520 simplex and 147.855 Chelsea Repeater. For information: William Aitenberndt, 3132 Timberline, Jackson, MI 49201.

MICHIGAN: The Independent Repeater Association's annual Grand Rapids Festival Swap & Shop, Saturday, June 5, 8 AM to 3 PM, Kentwood Field House, south of 60th Street on Kalamazoo Avenue. Admission \$3.00. 8 ft. swap tables \$7.00; \$4.00 half size. Prizes and refreshments. For information or dealer reservations: I.R.A. SWAP, 562 - 92nd St. S.E., Byron Center, MI 49315 or call (616) 455-2926.

MINNESOTA: The North Area Repeater Association's Swapfest and Exposition for radio amateurs and computer hobbyists, June 5, Minnesota State Fairgrounds, St. Paul. Admission \$3. Exhibits, booths, prizes. Free overnight parking for self-contained campers, June 4. Call wide area repeaters 25/85 or 16/76 for directions. For information/reservations: Amateur Fair, P.O. Box 30054, St. Paul, MN 55175.

MISSISSIPPI: Old Natchez Amateur Radio Club's Hamfest, Sunday, May, Natchez Convention Center. Doors open 8 AM. Free admission and swap tables. Food available. Talk-in on 146.31/91. For information: S.W. Gates, N5AXV, P.O. Box 203, Natchez, MS 39120.

MISSOURI & KANSAS: Pittsburg Repeater Organization's 8th annual Hamfest and Picnic, Sunday, May 23, Lincoln Center, Pittsburg, Kansas. Covered dish picnic, chicken and soft drinks supplied. Open 10 AM. Free parking; indoor flea market; door prizes. Grand prizes: FT-208R, Cushcraft Boomer, Ringo Ranger. Grand prize tickets (hams only) \$2.00 each to KC0ES, 505 Karen Drive, Carl Junction, MO 64834.

MISSOURI: The Indian Foothills Amateur Radio Club's 7th annual Hamfest, May 16, Saline County Fairgrounds Building, Marshall. Tickets \$2.00 each; 3/\$5.00 at door or 4/\$5.00 advance. No charge for tables but reservations requested. Doors open 8 AM. Coffee and rolls available till 10 AM. An all-you-can-eat lunch at 11:30. First prize drawing 2:30 PM for a KDK 2025 Mark II. Talk-in on .52, .28, .88 and 147.84/.24. For information and tickets: Jim Little, KB0DA, 405 E. Rosehill, Marshall, MO 65340. (816) 886-8583 after 5 PM or KB0VB (816) 886-2837.

NEW JERSEY: The Fort Monmouth ARC and Haverim are sponsoring the Jersey Shore Hamfest and electronic flea market, June 6, 9 AM to 4 PM, Jewish Community Center, 100 Grand Ave., Deal. Admission \$3 per person (children under 12 and XYLs free). Refreshments available. Door prizes. Table (\$5) and tailgating (\$2) spaces may be reserved by SASE and advance payment to: Jersey Shore Hamfest, P.O. Box 2078, Ocean, NJ 07712 by May 25. Talk-in on 147.045 and 6; 146.775/6; 146.52.

NEW YORK: The 30th annual ROME HAM FAMILY DAY sponsored by the Rome Radio Club, Sunday, June 6,

STILL MORE USABLE ANTENNA FOR YOUR MONEY . . . PLUS 30 Meters!

Butternut's new HF6V automatic bandswitching vertical lets you use the entire 26-foot radiator on 80/75, 40, 30, 20 and 10 meters (full quarter-wave unloaded performance on 15 meters). No lossy traps. Butternut's exclusive Differential Reactance Tuning™ circuitry uses rugged ceramic capacitors and large-diameter self-supporting inductors for radiation efficiency and DX performance unmatched by conventional multiband designs of comparable height.



For complete information concerning the HF6V & other Butternut products see your dealer or write for our free catalog.



**BUTTERNUT
ELECTRONICS
CO.**

GARY AIRPORT
BOX 356E Rte. 2
SAN MARCOS, TX 78666

**QUALITY VHF/UHF KITS
AT AFFORDABLE PRICES**
Call or Write for FREE CATALOG
(Send \$1.00 or 3 IRC's for overseas mailing)
See our full page ad in 73 Magazine

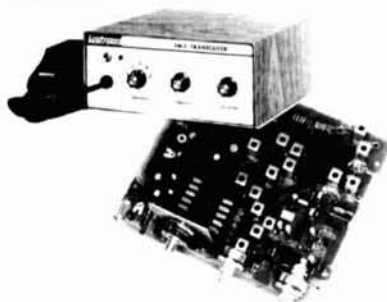

**FM TRANSCEIVERS
FM & AM RECEIVERS
FM EXCITERS & XMTRS
FM & SSB POWER AMPS
RECEIVING & TRANSMITTING
CONVERTERS FOR FM & SSB
LOW-NOISE PREAMPS
CLOWID's, COR's, RF TIGHT CASES**
For Repeaters, Links, OSCAR,
ATV, Mobile, Base, Scientific

hamtronics, inc.

65-R MOUL RD. • HILTON NY 14468
Phone: 716-392-9430

Hamtronics is a registered trademark

Beck's Grove, Oswego Road, Rome. Activities for Hams and non-Hams; door prizes, presentations of an educational and scientific nature, the area's largest Flea Market. An early brunch will be available as well as a fine buffet dinner. Talk-in on 28/88 and 146.55 simplex. Beck's Grove has overnight parking for campers as well as fly-in capabilities. For information: Rome Radio Club, P.O. Box 721, Rome, NY 13440.

NEW YORK: The Putnam Emergency Amateur Repeater League's first annual indoor Hamfest, Saturday, May 8, 9 AM to 4 PM, JFK Elementary School, Foggintown Road, off Route 312, Brewster. General admission 50¢. Exhibitors \$2.00. Talk-in on 52 and 146.135/144.535. For information/advance table registration: Frank Konecnik, WB2PTP, RD1-224C, Carmel, NY 10512.

NEW YORK: The Long Island Mobile Amateur Radio Club's Hamfair '82, May 23, Islip Speedway, Long Island. General admission \$2.00, exhibitors \$5.00 per car space. Refreshments available. Door prizes and special prizes drawn all day from 9 AM to 4 PM. Talk-in on 146.85. For information call Sid Wolin, K2LJH (516) 379-2861 or Hank Wener, WB2ALW (516) 484-4322 (evenings).

NORTH CAROLINA: The Durham FM Association's annual Durhamfest, May 15, South Square Mall, U.S. 15-501 south. Admission \$3.50 including dealers. Prizes, flea market, free tailgating spaces, overnight parking. Talk-in on 147.825/225. For information: Durhamfest, Box 777, Hillsborough, NC 27278.

OHIO: The Champaign Logan Amateur Radio Club's annual Hamfest and Flea Market, Sunday, June 13, Logan County Fairgrounds, Bellefontaine. Gates open 7 AM EDT. Hourly prize drawings 9 AM to 3 PM. Major prizes of \$200, \$100 and \$50 drawn at 3 PM. Tickets \$1.50 advance, \$2.00 door. Tables \$3.00 advance. Contact M.A. Griswold, WB8JXM, P.O. Box 301, Urbana, OH 43078 for information, tickets or tables.

OHIO: The 15th annual Goodyear ARC Hamfest, Sunday, June 13, 10 AM to 5 PM, Goodyear Wingfoot Lake Park, near SR224 and 43 east of Akron. Family admission \$2.50 advance, \$3.00 gate. Outside flea market \$1.00 per space. Inside dealers \$5.00 per table. Suggest reservations. Prize drawings throughout day. Grand prizes: First — Kenwood TS-830S; second — Yaesu FT-290R; third — Kenwood TR-2500 and more. Ladies' prizes too. For tickets and information SASE to Don W. Rogers, WA8SXJ, 161 S. Hawkins Avenue, Akron, Ohio 44313. (216) 864-3665.

OHIO: The Athens County ARA annual Hamfest, Sunday, May 16, Athens City Recreation Center, East State St., 8 AM to 4 PM. Free flea market for electronics-related items. Setup 7 AM. Tickets \$1 advance; \$2 gate. Nearby restaurants and recreation area. Talk-in on 34/94. For information SASE to: ACARA, P.O. Box 72, Athens, Ohio 45701 or telephone Joe Follrod, WB8DOD, (614) 797-4874.

OHIO: The Ohio Radio Club and the Ottawa County Amateur Radio Club and area dealers are sponsoring a Hamfest, May 23, Fremont, Ohio, Fairgrounds. Gates open 8 AM. Dealer setup 7 AM. Advance tickets \$2.50, \$3.00 door. Talk-in on 31/91 and 52. For table reservations/tickets SASE to: John Dickey, WB8CDR, 545 N. Jackson St., Fremont, OH 43420.

OREGON: The Oregon State Ham Convention co-sponsored by the North Coast Repeater Association and the Oregon Tualatin Valley Amateur Radio Club, June 4 - June 6, Seaside Convention Center, Seaside. Friday 12 Noon to 5 PM; Saturday 8 AM to 9:30 PM; Sunday 8 AM to 2 PM. Registration \$5.00/single; \$7.00/couple; \$1.00 children. A special ticket for a drawing of either an Icom 2AT, 3AT, or 4AT plus extra tickets for main prize drawing will be given to those who preregister before March 31. Registrations between April 1 and 30 will receive one extra ticket for main prize drawing. Seminars on receiver design, construction, contests and more. Talk-in on 146.52 and local repeater 145.45. For information/reservations: Doc McLendon, W7GWC, P.O. Box 920, Seaside, OR 97132.

PENNSYLVANIA: The 11th annual MARC (Milton Amateur Radio Club) Hamfest, June 6, rain or shine, Allenwood Firemen's Fairgrounds, U.S. Rt. 15, 8 AM to 5 PM. Advance registration \$2.50; \$3.00 gate. XYLs and children free. Flea market, auction, contests. Cash door prizes. Camping and motels nearby. Talk-in on 37/97, 025/625 and 52 simplex. For details: Jerry Williamson, WA3SXQ, 10 Old Farm Lane, Milton, PA 17847. (717) 742-3027.

PENNSYLVANIA: The 28th annual Breeze Shooters Hamfest, May 23, Noon to 5 PM, White Swan Amusement Park, PA, Rt. 60 near Greater Pittsburgh International Airport. Registration \$2.00 each; 3/\$5.00. Free flea market, prizes, family amusement park. Talk-in on 146.28/88 or 29.0 MHz. Contact Joe Kyler, K3SJD, 4430 Evergreen Road, Pittsburgh, PA 15214. (412) 931-2756.

PENNSYLVANIA: The Warminster Amateur Radio Club's annual Hamfest, Sunday, May 16, Middletown Grange Fairgrounds, Wrightstown (near Philadelphia), 7 AM to 3

Tristao Tower Co.
209 733-2438

Lou Tristao introduces today's premier freestanding crankup tower line.

- Hot Dipped Galvanized Finish
- Check
- Size
- Capacity
- Versatility
- Strength
- Conservative Design
- Ease of Installation

We invite Comparison!

Complete Engineering Calc's available — to UBC Standards
Write or call for complete information



**CRANK-UP TOWERS
MASTS • TRAILERS**

**P.O. Box 3715
VISALIA, CA 93278**

SMITHE

**INDOOR
ANTENNA SYSTEM**

Guaranteed to work —
or your money back!

Trapped indoors? Need an antenna that really works? Then try our BANTAM DIPOLE for coverage of all bands from 80 to 2 meters.

SPECIFICATIONS:

80, 40, 20, 15, 10, 6, 2 meters
(band change with coil taps)

Covers NEW 30, 17, 12 a bands.

Full 3.4 to 30 MHz. coverage —
Great for SWL and MARB.

Operates full size at 13' long,
reduced size at 7' long.

Quick knock-down/set-up system.

INTEGRAL tuner and balun —
matches 50 ohm coax.

Rated at 250 W. RF.

Needs NO ground system.

Polarizations: vert. or horiz.

Weight 8 lbs. Mounts anywhere.

Great for Field Day!
A real boon to the apartment man.
Ideal for traveling.

U.S. PATENT 4,207,574

• \$73.95

Optional carrying case — \$10.00

Smith Aluminum P.O. Box 273
Bonifay, FL 32425 (904) 547-4411

**Bind 'em
and
Find 'em**



Keep those valuable issues of Ham Radio like new. Prevent smears, tears and dog ears. Bind 'em together and enjoy for years to come. You'll be happy you did!

HAM RADIO BINDERS

Beautiful buckram bound, rich brown material with gold embossing. These binders will really dress up your collection of Ham Radio. Year stickers included.

HR-BDL \$6.95 ea.
3 for \$17.95

Please add \$2.00 for shipping and handling.

**HAM RADIO'S BOOKSTORE
GREENVILLE, NH 03048**



Digital Multimeter

The Drake DM2350 Digital Multimeter is a convenient, small handheld liquid crystal display meter ideal for the serviceman or hobbyist. This 3 1/2 digit meter is auto-ranging, auto-zeroing, has polarity indication, and an over-range warning signal. Battery life is greater than 300 hours with a "low battery" indicator. A continuity test sounds a signal when circuit resistance is less than 20 ohms. Dc accuracy is a basic 0.8%.

Batteries, probes, 20 amp current shunt, spare fuse and soft carrying case all included at **\$95.95**

Add **\$2.50** shipping and handling per order.

Send check with order and provide street address for UPS shipping. Ohio residents add Sales Tax. Charge card buyers may call toll free:

1-800-543-5612

DRAKE In Ohio, or for information call: **1-513-866-2421**

R. L. DRAKE COMPANY

540 Richard Street, Miamisburg, Ohio 45342

INSTITUTIONAL AND DEALER INQUIRIES INVITED

PM. Admission \$3.00 gate; \$2.00 additional for each seller space. Children and spouse free. Pre-registration by May 1, \$1.00 off admission. Door prizes every half hour starting 9 AM. Talk-in on 147.690/090 and 146.52 simplex. For information: P.O. Box 113, Warminster, PA 18974 or call Bill Scott, KA3CHB after 6 PM (215) 249-0568.

PLAYBOY RESORT at Great Gorge, McAfee, NJ — the place to relax and enjoy — see all the manufacturers' and dealers' exhibits — attend the vital and informative forums — renew old acquaintances and make new ones — all at the ARRL Hudson Division Convention, October 30-31. Send SASE now for complete details to HARC, Box 528, Englewood, NJ 07631.

TENNESSEE: The ARRL Delta Division Convention and 16th annual Knoxville Hamfest, May 22 and 23, Bearden High School, 8352 Kingston Pike, Knoxville, Saturday 9 AM to 5 PM; Sunday 10 AM to 4 PM. General Admission: \$2 advance; \$3 door. All tickets good for grand prizes and door prizes. Exhibitors \$8/table both days; \$5/table one day. Grand prizes: cash plus many door prizes. Bonus prize Saturday morning drawn on advance tickets. Forums: DX, ARRL, fast scan TV. Women's programs, outdoor flea market, own tables. Saturday banquet, 7:30 PM, Sheraton Executive Park, Knoxville, tickets \$15.00. For information, tickets, reservations: Raymond Adams, N4BAQ, 5833 Clinton Hwy., Suite 203, Knoxville, TN 37921. (615) 688-7771 Days. (615) 687-5410 Nights.

TENNESSEE: The Humboldt ARC's annual Hamfest, Sunday, June 6 at New Location — Bailey Park, N. 22nd Avenue, Humboldt. Tickets \$2.00. Prizes, flea market, ladies' and children's activities. For information: Ed Holmes, W4IGW, 501 N. 18th Avenue, Humboldt, TN 38343.

KNOXVILLE TENNESSEE: See World's Fair while attending 1982 Knoxville Hamfest and ARRL Delta Division Convention, Memorial Day Weekend (May 22-23). DX, computer, and technical forums; air-conditioned exhibit area; and large indoor/outdoor flea market make this Tennessee's largest Hamfest. More information? (dealers, tickets, reservations) N4BAQ, 5833 Clinton Hwy., Suite 203, Knoxville, Tenn. 37912.

VIRGINIA: The Ole Virginia Hams ARC of Manassas announces its eighth annual Mid-Atlantic are Quality Hamfest, June 6, Prince William County Fairgrounds. Gates open 8 AM. Tailgating setup 7 AM. Admission \$4.00, children under 12 free, tailgaters \$3.00 additional per vehicle. Indoor/outdoor exhibits, YL program, refreshments available. Fantastic prizes. Bring your family. Talk-in on 37/97 and 52 simplex. For information: Jim Lascaris, WA2QEJ, 11053 Camfield Ct., Manassas, VA 22110.

WEST VIRGINIA: The Tri-State Amateur Radio Association's 20th annual Huntington Hamfest, Sunday, June 13, Camden Park off route 60 west. 9 AM to 3 PM. Registration \$3 per person. Children under 12 free. Flea market \$3 per space. Overnight parking for self-contained RVs. Talk-in on 146.04/64 and 146.52/52 W8VA. For information: SASE to T.A.R.A., Inc., P.O. Box 4100, Huntington, WV 25729.

WISCONSIN: The 7th annual Swapfest of the Green Bay Mike and Key, Saturday, May 22, Norwood School, corner of 9th and Norwood, Green Bay. 8 AM to 3 PM. Advance tickets \$1.50 (by May 1), \$2.00 door. Tables \$2.00/4 ft. space. Free admission for one for every 2 tables bought. Door prizes. Refreshments available. Talk-in on 146.52 and 147.72-12. For information: Robert Duescher, 1011 - 13th Avenue, Green Bay, WI 54304.

ONTARIO: The Guelph Amateur Radio Club's 7th annual Central Ontario Flea Market, Saturday, June 5, 8 AM to 4 PM, Regal Hall, 340 Woodlawn Road West, Guelph. Admission \$2.00; under 12 free. Vendors \$3 additional. Tables available at \$5 each. Commercial displays, surplus dealers, computer software/hardware. Refreshment concession. For information: Bob Lacombe, VE3IYE, (519) 843-4618 or Rocco Furfaro, VE3HGZ, (519) 824-1157.

OPERATING EVENTS "Things to do..."

MAY 12-16: The Holland Amateur Radio Club will operate K8DAA with other participating stations for the Netherlands-American Bicentennial during Tulip Time. Operations on all phone bands and possibly some CW. One contact with K8DAA or two participating stations qualifies for certificate. QSL to HARC, P.O. Box 92, Zeeland, MI 49464.

MAY 15 & 16: The Rockingham County ARC will be operating from the Cape Hatteras Lighthouse on the Outer Banks of North Carolina. This is the tallest brick lighthouse in the country and is designated as a National Historic Landmark. Operating frequencies: 30 Kc up from bottom of general portion of each band, phone and CW.

HATRY

Your ANTENNA Headquarters

Cushcraft
Hy-Gain
Hustler
Antenna Specialists
Larsen
B&W
Rohn Tower
&
Books from
ARRL, Bash,
Hayden, Ameco,
Shrader

HATRY ELECTRONICS
500 LEDYARD STREET
HARTFORD, CT 06114
(203) 527-1881
SHIPPING F.O.B. HARTFORD, CT

SEND FOR THIS FREE CATALOG NOW

SAVE MONEY HIGH QUALITY FAST DELIVERY

We are utilizing the latest equipment and technology to maintain our quality at reasonable prices.

- General Communication
- Industry
- Marine VHF
- Scanners
- Amateur Bands
- CB Standard
- CB Special
- Microprocessor

Call or Write JAN OR CRYSTALS
P.O. Box 06017
Ft. Myers, Fl. 33906-6017
All Phones (813) 936-2397

JAN CRYSTALS

V54

TRANSI-TRAP

Lightning & Static Protectors

Models
LT,
LT/N

*Don't hook-up
your coax
without one!*

Models
R-T,
HV

Protects sensitive solid state components in your equipment from high-surge voltages produced by nearby lightning strikes, high wind, and static build-up. Even distant storm fronts are known to cause damaging surges without warning or time for grounding.

The replaceable Arc-Plug™ cartridge, which can fire thousands of times, utilizes a special ceramic gas-filled tube with precisely tailored firing speed and level, safely by-passing surges to ground. Standard air-gap devices are ineffective due to their erratic performance.

Transi-Trap Protectors are the first devices in the industry designed with "isolated ground." This keeps damaging arc-energy off the chassis and routes it directly to ground.

Ohio residents add Sales Tax. **MasterCard, Visa, checks accepted.** Order by phone or mail.

AlphaDelta Transi-Trap Protection Systems are designed to reduce the hazards of lightning-induced surges. These devices, however, will not prevent fire or damage caused by a direct stroke to antenna or other structure.

ALPHA DELTA COMMUNICATIONS

P.O. Box 571, Centerville, Ohio 45459 • (513) 435-4772



MAY 16 & 17: W7AQ, the Yakima Amateur Radio Club, will operate a special event station in commemoration of the second anniversary of the eruption of Mt. Saint Helens in Washington State. Join us at 1800 May 16 to 0200 May 17 UTC. Frequencies will be 25 kHz up from bottom of General phone edge; CW up 25 kHz from Novice band edge and at 14.050, all ± QRM and band conditions. A QSL will be available for a SASE to W7AQ, Yakima ARC, P.O. Box 9211, Yakima, WA 98909.

MAY 21-30: The Wiesbaden Amateur Radio Club announces its seventh annual DXpedition to Liechtenstein, callsign DA1WA/HB0. CW, phone and RTTY, all frequencies, 10 to 160 meters including three new WARC bands. CW operations for American stations will be attempted at 3.725 and 21.120 MHz between 1900 and 2100 EST. Stateside QSLs SASE to Stephen Hutchins, Box 4573, APO New York 09109.

MAY 22 & 23: The Clark County Amateur Radio Club, W7AIA, announces the 2nd annual Mount Saint Helens QSO Party. May 22 0001 UTC through 2359 UTC May 23. Frequencies: SSB — 3.805, 7.230, 14.280, 21.360, 28.505. CW — 3.705, 7.105, 21.105, 28.105. VHF — Various Vancouver and Portland area repeaters. To apply for a Mt. Saint Helens Award, send log information or QSL card and \$2.00 (or 8 IRCs) to: Award Manager, W7AIA, P.O. Box 1424, Vancouver, WA 98668. All proceeds from the award will go to the Reid Blackburn Scholarship Fund which has been established by the Vancouver newspaper "The Columbian". Reid, KA7AMF, an active member of the club, lost his life during the disastrous eruption of May 1980 while monitoring a U.S.G.S. observation station near the base of Mt. Saint Helens.

MAY 22 TO JUNE 7: The Smiths Falls Amateur Radio Club will be operating a special events station, CZ35FR, on all HF bands and 2 meters VHF, commemorating the 150th anniversary of the Rideau Canal System linking Ottawa and Kingston. For a special QSL send business SASE to: P.O. Box 215, Smiths Falls, Ontario, Canada K7A 4T1.

MAY 29 & 30: The Neffs Area Amateurs (Belmont County) will operate WB8TQG, the smallest Ham Radio shack in Neffs, Ohio. Work us and let us know if you have a smaller one. May 29 1600Z to May 30 2200Z. Frequencies: Phone 146.46, 28.610, 21.410, 14.340, 7.265, 3.965. CW 28.120, 21.120, 7.120, 3.720. Certificate for QSL card and business SASE to WB8TQG, Floyd, P.O. Box E, Neffs, OH 43940.

MAY 29 & 30: The Orange County ARC will operate WB2TSA to celebrate the Club's tenth anniversary and the Diamond Jubilee of the city of Port Jervis, New York. May 29 1400-2200 UTC and May 30 1400-2000 UTC. Frequencies: 10 kHz up from lower General phone bands. SASE for QSL to OCARC, P.O. Box 434, Cornwall-On-Hudson, New York 12520.

MAY 31: The Bishop Amateur Radio Club will operate KA6AMT from the Mule Capitol of the World, Bishop, California, in recognition of the annual Mule Days celebration. Frequencies: Phone — 3.905, 7.240, 14.295, 146.34/94. For certificate SASE to: Bishop Amateur Radio Club, P.O. Box 1024, Bishop, CA 93514.

JUNE 5: The Pennyroyal Amateur Radio Society's annual Jefferson Davis QSO party, on Saturday, 1500 to 2400 UTC. Suggested frequencies: 3.940, 7.260, 14.310, 21.410 and 28.610 MHz phone and 3.730 MHz CW. An attractive certificate for contacts made that day will be available.

JUNE 5 & 6: Fort Delaware, on Pea Patch Island, Delaware, will be the site of a mini-expedition by Wilmington area hams operating in the General portion of the HF bands during daylight hours only, each operator using his own call and the Fort Delaware identifier. Operators include N3ACU, Doug; N3ARU, Dwight; N3ARV, Ned; KB3HZ, Allen; KB3PD, Rick. This will be the first HF Amateur communications from the fort in the middle of the Delaware River where many Confederate prisoners of war were held during the Civil War. Commemorative QSL cards will be issued for contacts supplying SASEs.

JUNE 12: The Tri-City Amateur Radio Club will operate a special event station from the replica of Stonehenge, near Maryhill, Washington. W7VPA will operate from 1600 to 0100 UTC on or near 3.900, 14.290, 28.690 and 146.52. An attractive certificate will be awarded. Send QSL info and \$1.00 to W7VPA, Special Event, P.O. Box 73, Richland, WA 99352.

TO MILITARY COMMUNICATORS: If you have ever served, or are currently serving, with the U.S. Army Signal Corps, either in the military or as a civilian employee, you are invited to join the U.S. Army Signal Corps Association. Communicators from sister services and allies are also welcome to join. Members of the Association receive copies of the *Army Communicator*, the voice of the Signal Corps, as a benefit of membership. Additional information and applications for membership are available by contacting: Signal Corps Association, P.O. Box 7740, Fort Gordon, Georgia 30905.



The HAM SHACK

808 N. Main • Evansville, IN 47711

TEN-TEC Solid State at Affordable Prices

546 Omni-C Xcvr \$975
580 Delta 679
525 Argosy 439

AEA Morsematic MM-2 Keyer 125
AEA MBA Reader 269
AEA Isopole 144 MHz 35
ALLIANCE HD73 99
ASTRON RS12A 69
AZDEN PCS-3000/300 289
BENCHER BY-1 36
BUTTERNUT HF6V Vertical 99
CUBIC Astro 103 1150
DAIWA CNA2002 2.5 KW Auto Tuner 425
HAL CT2100 695
HY-GAIN TH7 DX 695
HY-GAIN HAM IV Rotator 169
ICOM 720A/PS15 1275
ICOM 251A 585
ICOM 2AT 235
KLM KT34XA 465
KLM KT34A 315
KANTRONICS Interface 169
MFJ 496 Keyboard 289
MIRAGE B1016 239
SANTEC 144/μP 2m Hand-Held 295

812-422-0231

MON-FRI 9AM-6PM • SAT 9AM-3PM

Write for our new and used equipment list

GOTHAM ANTENNAS

(305) 294-2033



SMALL LOT TRAP DIPOLES

MODEL	BANDS	LGTH	PRICE
TSL 8040	80.40	78'	\$49.95
TSL 4020	40.20, 15'	40'	\$47.95

SMALL LOT SHORTENED DIPOLES

SL 8010	80.40, 20'	75'	\$59.95
	15.10'		
SL 160	160	130'	\$36.95
SL 80	80	63'	\$35.95
SL 40	40.15	33'	\$34.95

FULL SIZE PARALLEL DIPOLES

FPD 8010	80.40, 20'	130'	\$49.95
	15.10'		
FPD 4010	40.20, 15.10'	63'	\$44.95

NEW! PORTABLE VERTICAL! IDEAL FOR

APARTMENTS, CAMPING, TRAILERS!

Folds to 5' Package No Radials. Required Fully Assembled. Full Legal Limit 1:1 VSWR

MODEL	BANDS	HGHT	PRICE
PV 8010	80.10	13'	\$59.95

PROVEN DESIGN - GOTHAM ALL BAND

VERTICALS

V 160	160.80.40.20.	23'	\$39.95
	15.10.6		
V 80	80.40.20.	23'	\$37.95
	15.10.6		
V 40	40.20.15.10.6	23'	\$35.95

FAMOUS GOTHAM QUADS

2 Elements — 3 Bands Complete \$119.95

CHAMPIONSHIP GOTHAM BEAMS

Full Size Complete from \$79.95

DEALER INQUIRIES INVITED

CALL OR SEND LARGE SASE FOR CATALOG. Shipping: Dipoles & Verticals \$2.50 USA, \$7.00 Canada, \$5.00 FPO. APO Beams & Quads Shipped UPS or Freight Collect. Fla. add 4% Sales Tax

1415 First St. • Key West, FL 33040

Advertisers check-off

... for literature, in a hurry — we'll rush your name to the companies whose names you print below. It's simple to do. Simply select the advertiser's number and name from the Advertisers' Checkoff list found on the same page as the Advertisers' Index. Just print the number and the company's name and drop in the mail.

NUMBER	NAME OF COMPANY	NUMBER	NAME OF COMPANY
_____	_____	_____	_____
_____	_____	_____	_____
_____	_____	_____	_____
_____	_____	_____	_____
_____	_____	_____	_____
_____	_____	_____	_____
_____	_____	_____	_____

Please month _____ Mar. _____ April _____ May _____ **Limit 14 inquiries please.**

NAME _____ CALL _____

ADDRESS _____

CITY _____ STATE _____ ZIP _____

AFFIX POSTAGE
OR
POST OFFICE
WILL NOT
DELIVER

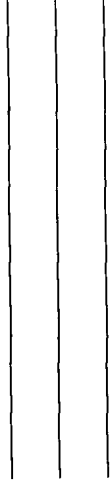

ham
radio
magazine

READER SERVICE CENTER
P.O. BOX 358
ARLINGTON, MA 02174

ATTN: Reader Service Dept.

Radio Handbook

by Bill Orr

NEW 22nd EDITION

The Radio Handbook has been a best seller for over 45 years. This brand-new edition covers in complete detail all of the latest state-of-the-art advances in electronics. Hams and engineers alike will find this handy, single-source reference an invaluable aid. Chock-full of projects from simple test equipment to complex receivers and amplifiers. Chapters include an explanation of Amateur Radio communications, electronic and electrical theory, tubes and semiconductor devices; a special chapter on RFI and more . . . This invaluable book is a must for every ham-shack. Orders yours today and save. 1136 pages. ©1982 □21874

\$34.95

Please add \$2.00 for shipping and handling.

ham radio's
BOOKSTORE
Greenville, NH 03048

Now, portable electric power that's as reliable as the sun.

Get uninterrupted, maintenance-free electric energy for years.

Introducing SolarTrek™, a new and innovative line of portable solar-powered generators. Utilizing photovoltaics, SolarTrek simply and safely converts sunlight directly into electrical energy.

Available in many power-rated models, each system comprises a solar cell array, battery storage pack (for full power on rainy days and at night) and solid-state controller. Each boasts one-person portability, rugged design and superior reliability.

With SolarTrek you can have fuel-free, maintenance-free and pollution-free electrical power. Year after year. Day or night. Rain or shine. Anywhere in the world.

Modular design lets you plan for any power requirement.

SolarTrek is modular and upgradeable. The basic system will power tools, appliances, communications and refrigeration equipment, and lighting. Add power anytime by ex-

panding the solar array. All systems offer a choice of battery packs and AC or DC output.

SolarTrek requires no technical expertise to operate. There are no moving parts. Set-up is a simple matter of three quick-connect components and tilting the array toward the sun.

SolarTrek eliminates the problems associated with conventional portable generators. Now you can have a fuel-free, trouble-free source of electric power that will last as long as the sun.

Send \$3 for a product brochure that describes many practical and economical

uses, to: Solar Innovations Corp., 18 Cloverdale Ave., Salem, MA 01970.



SOLAR INNOVATIONS CORPORATION

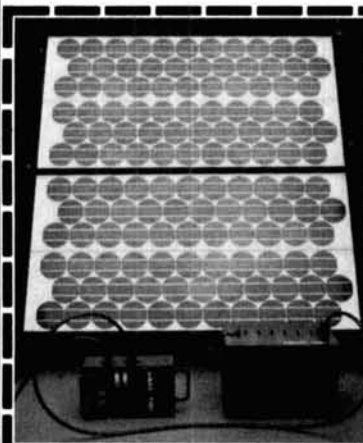

I'm interested in energy independence.

Enclosed is \$_____ to cover postage and handling. Please send the following product information:

SolarTrek portable systems (\$3)

Name _____

Address _____

City _____

State _____ Zip _____

Return to: Solar Innovations Corp.
18 Cloverdale Ave., Salem, MA 01970

Advertisers check-off

... for literature, in a hurry — we'll rush your name to the companies whose names you "check-off"

Place your check mark in the space between name and number. Ex: Ham Radio 234

AEA ... 677	JDL ... 986
Advanced Receiver Research ... 919	Jameco ... 333
Alaska Microwave ... 826	Jan ... 067
All Elec. ... 926	Jensen ... 293
Alliance ... 700	KLM ... 073
Alpha Delta ... 949	Kenwood *
Amateur Elec. Supply ... 659	Kernco *
ARRL ... 780	MFJ ... 082
Amidon ... 005	Madison ... 431
Atlantic Surplus *	Microcraft ... 774
Barker & Williamson ... 015	Microlog ... 982
Barry *	Micro Security ... 939
Bencher ... 629	Microwave Filter ... 637
Ben Franklin ... 864	J.W. Miller ... 745
Bilal ... 817	Mirage ... 760
Britt's 2-Way Radio ... 953	N.P.S. ... 866
Butternut *	Nermal ... 968
CES ... 985	Oak Hill Academy A. R. S. *
C-Z Labs ... 980	P.B. Radio ... 921
Centurion ... 798	P.C. ...
Certified Int. ... 976	Palomar Eng. *
Command Productions *	Panasonic ... 683
Comm. Concepts ... 797	Phillips-Tech ... 936
Comm. Spec. ... 330	Pipo ... 481
Drake *	Pro-Search ... 983
EEB ... 288	Callbook ... 100
EGE ... 901	Radiokit ... 801
ETCO ... 856	Radios Unlimited ... 941
Fair Radio ... 048	Radio Warehouse *
G & K ... 967	Radio World ... 592
GLB ... 552	Smithe ... 930
Gem Quad *	Solar ... 987
Gilfer Assoc. *	Spectronics *
G.I.S.M.O. ... 691	Spectrum Int. ... 108
Gotham Antennas ... 981	Telrex *
Grove ... 848	Texas Towers ... 681
Hal Comm. ... 057	The Comm Center ... 634
Hal-Tronix ... 254	Tristao ... 984
H. R. B. ... 150	Universal Comm. ... 885
Ham Shack ... 879	Universal Elec. ... 653
Hamtronics, N.Y. ... 246	UNR Rohn ... 410
Hatry ... 889	Valor ... 946
Heath ... 060	Vanguard Labs ... 716
Icom *	Webster Assoc. ... 423
	Western Elec. ... 909
	Yaesu ... 127

*Please contact this advertiser directly.

Limit 15 inquiries per request.

May, 1982

Please use before June 30, 1982

Tear off and mail to
HAM RADIO MAGAZINE — "check off"
Greenville, N. H. 03048-0498

NAME

CALL

STREET

CITY

STATE ZIP

look here

call toll free:nights
1-800-231-3057

(TEX. RES. Call Collect 7-10 PM CT.
M.W.F. 1-713-721-7920)

days 1-713-658-0268

YAESU	FT1 ... 2395.00
	FT902DM ... 1249.00
	FT101ZD: Mark 3 749.00
	FT208R: 708R 289.00 ea
ICOM	IC3AT/IC4AT 269.00 ea.
	IC25A ... 309.00
	IC730 ... Call
	IC2AT ... 249.00
	IC22U ... 269.00
ROBOT	800A (+ Rebate) 749.00
	400A (+ Rebate) 675.00
KLM	KT34XA ... 469.00
	KT34A ... 309.00
	144-14816C ... 89.95
DRAKE	TR5 ... 995.00
	TR7A ... 1495.00
	R7A ... 1450.00
AEA	CK1 ... 115.00
	CK2 ... 89.00
	MBA RO ... 269.00
	MBA-RC ... Call
ROCKWELL	KWM380 ... 2795.00
COLLINS	Hi S/N, All mods. ...
	Accessories 10% Off List
KENWOOD	Complete Line ... Call
AMPHENOL	Silverplate PL259 1.00
SAXTON	450 OHM Open Wire
	Ladderline ... 20¢ ft
BELDEN	9405, 8214, 9258, 8267
	9251 — Stock Call
HAL	CWR685A
	+ Keyboard ... 875.00
	CT2100 ... 699.00
	KB2100 ... 159.00
World Radio	TV Handbook
	... 16.50 ppd. UPS
HYGAIN	TH7DX ... 349.00
10% Off	Curtis, Sherwood, Palomar
BUTTERNUT	HF6V Vertical ... 100.00
TONNA	F9FT, 9 EL 2 Meter 30.00
KANTRONICS	Minireader ... 249.00
	MicroRTTY ... 249.00
ANTIQU	Rare Tubes ... Call!
MOSLEY	Antennas ... Call!

MASTERCARD VISA

All prices fob Houston except where indicated. Prices subject to change without notice, all items guaranteed. Some items subject prior sale. Texas residents add 6% tax. Please add sufficient postage, balance collect.

MADISON
Electronics Supply
1508 McKinney
Houston, Texas 77010

Advertisers iNdex

AEA, Advanced Electronic Applications	73
Advanced Receiver Research	59
Alaska Microwave Labs	93
All Electronics Corp.	85
The Alliance Manufacturing Company, Inc.	80
Alpha Delta	96
Amateur Electronic Supply	41
American Radio Relay League	88
Amidon Associates	58
Atlantic Surplus Sales	101
Barker & Williamson, Inc.	101
Barry Electronics	36
Bencher, Inc.	86
Ben Franklin Electronics	85
Bilal Company	89
Britt's 2-Way Radio	80
Butternut Electronics	93
C-Z Labs	90
Certified International	92
Command Productions	92
Communications Concepts	74
Communications Specialists	1
Drake, R.L., Co.	2, 56, 79, 90, 95
EEB	74
EGE, Inc.	77
ETCO	86
Fair Radio Sales	58
G & K Amateur Supply	84
GLB Electronics	89
Gem Quad	91
Gilfer Associates, Inc.	92
G.I.S.M.O.	82
Gotham Antennas	96
Grove Enterprises	91
Hal Communications Corp.	22, 23
Hal-Tronix	46
Ham Radio's Bookstore	49, 74, 78, 80, 84, 88, 90, 92, 94, 101
The Ham Shack	96
Hamtronics, N.Y.	94
Hatry Electronics	95
Heath Company	49
Icom America, Inc.	Cover II
JDL	102
Jameco Electronics	81
Jan Crystals	95
Jensen Tools, Inc.	86
KLM Electronics, Inc.	30
Trio-Kenwood Communications	52, 53, Cover IV
Kernco	88
MFJ Enterprises	9
Madison Electronics Supply	59, 100
Microlog	11
Micro Security	82
Microwave Filter, Inc.	29
J.W. Miller Division, Bell Industries	75
Mirage Communications Equipment, Inc.	87
N.P.S., Inc.	88
Nermal Electronics	58, 90
Oak Hill Academy Amateur Radio Session	90
P.B. Radio	58
P.C. Electronics	82
Palomar Engineers	101
Panasonic	17
Phillips-Tech Electronics	87
Pipo Communications	86
Pro-Search Electronics	4
Radio Amateur Callbook	101
Radiokit	85
Radios Unlimited	79
Radio Warehouse	93
Radio World	88
Smithe Aluminum	74, 94
Solar Innovations Co.	99
Spectronics	87
Spectrum International, Inc.	57
Telrex Laboratories	71
Texas Towers	84
The Comm Center	91
Tristao Company	94
Universal Communications	43, 79
Universal Electronics, Inc.	88
UNR-Rohn	85, 86
Vanguard Labs	58
Webster Associates	58
Western Electronics	101
Yaesu Electronics Corp.	Cover III

new COAX SWITCHES

from Barker & Williamson

Model 593

- **Single Pole 3** Position with grounding of all unused positions
- **Crosstalk** (measured at 30 MHz) is -45db between adjacent outlets and 60 db between alternate outlets



Model 594

- **2 Pole 2 Position**
- **Crosstalk** 45db (measured at 30 MHz)



Specifications for both switches

- **Power** 1 KW-2 KW PEP
- **Impedance** 50-75 ohms
- **VSWR** 1.2:1 up to 150 MHz
- **Dimensions** 1 3/4" high, 5" wide, 3" deep
- **Weight** 1 lb.
- **Mount** Wall or desk

Available at your B&W dealer



Barker & Williamson, Inc.
10 Canal St. Bristol, Pa. 19007
Telephone: (215) 788-5581

ALL BAND TRAP VERTICAL ANTENNAS!

FULL 1/4th WAVE - All Bands! Automatic Selection with proven Hi-Q Traps. 3 Models-ALL self supporting - Ground or roof mount. HI STRENGTH FIBERGLASS TUBING OVER - ALL. NO WOBBLY, LUMPY TRAPS - NO UN-SIGHTLY CLAMPS needed - Size 1 1/4" all the way up - Traps hidden inside. You can use it in a 1 ft. sq. Backyard FOR APARTMENTS, MOBILE HOMES - CONDOS etc. where minimum space and neat appearance is MANDATORY! Instant "Drive In" ground mount (included). Use with or without radials (included). (All angle roof mount - Extra) COMPLETELY PRE-TUNED - NO ADJUSTMENTS NEEDED EVER! NO TUNER NEEDED FOR MOST TRANSCEIVERS! Use - RGPU feedline, any length! 2000 Watt PEP, input power. Shipped - PREPAID IN USA. Assembles in 10 min. using only screwdriver. WEATHERPROOF!

No.-AVT80-10 - 5 Band - 29" H" - \$169.95
No.- AVT40-10 - 4 Band - 19"3" - \$119.95
No.- AVT20-10 - 3 Band - 11"6" - \$89.95

SEND FULL PRICE FOR PP DEL IN USA (Canada is \$5.00 extra for postage, clerical, Customs etc.) or order using VISA, MASTER CARD or AMER-EXP. Ph 1-308-236-5333 9AM-6PM weekdays. We ship in 2-3 days. All Antennas Guaranteed for 1 year - 10 day money back trial. Free Inf.

WESTERN ELECTRONICS

Dept. AR-5 Kearney Ne. 68847

FACSIMILE

COPY SATELLITE PHOTOS,
WEATHER MAPS, PRESS!

The Faxes Are Clear - on our full size (18-1/2" wide) recorders. Free Fax Guide

TELETYPE

RTTY MACHINES, PARTS, SUPPLIES

ATLANTIC SURPLUS SALES (212) 372 0349
3730 NAUTILUS AVE BROOKLYN NY 11224

SAY YOU SAW IT
IN
HAM RADIO

When it comes to AMATEUR RADIO QSL's...



it's the
ONLY BOOK!

US or Foreign Listings

1982 callbooks

Here they are! The latest editions. World-famous Radio Amateur Callbooks, the most respected and complete listing of radio amateurs. Lists calls, license classes, address information. Loaded with special features such as call changes, prefixes of the world, standard time charts, worldwide QSL bureaus, and more. The U.S. Edition features over 400,000 listings, with over 70,000 changes from last year. The Foreign Edition has over 370,000 listings, over 60,000 changes. Place your order for the new 1982 Radio Amateur Callbooks, available now.

	Each	Shipping	Total
<input type="checkbox"/> US Callbook	\$18.95	\$3.05	\$22.00
<input type="checkbox"/> Foreign Callbook	\$17.95	\$3.05	\$21.00

Order both books at the same time for \$39.95 including shipping.

Order from your dealer or directly from the publisher. All direct orders add shipping charge. Foreign residents add \$4.55 for shipping. Illinois residents add 5% sales tax.



SPECIAL LIMITED OFFER!
Amateur Radio
Emblem Patch
only \$2.50 postpaid

Pegasus on blue field, red lettering. 3" wide x 3" high. Great on Jackets and caps.

ORDER TODAY!

RADIO AMATEUR
callbook INC.



Dept. F
925 Sherwood Drive
Lake Bluff, IL 60044, USA

R-X Noise Bridge



- Learn the truth about your antenna.
- Find its resonant frequency.
- Adjust it to your operating frequency quickly and easily.

If there is one place in your station where you cannot risk uncertain results it is in your antenna.

The Palomar Engineers R-X Noise Bridge tells you if your antenna is resonant or not and, if it is not, whether it is too long or too short. All this in one measurement reading. And it works just as well with ham-band-only receivers as with general coverage equipment because it gives perfect null readings even when the antenna is not resonant. It gives resistance and reactance readings on dipoles, inverted Vees, quads, beams, multiband trap dipoles and verticals. No station is complete without this up-to-date instrument.

Why work in the dark? Your SWR meter or your resistance noise bridge tells only half the story. Get the instrument that really works, the Palomar Engineers R-X Noise Bridge. Use it to check your antennas from 1 to 100 MHz. And use it in your shack to adjust resonant frequencies of both series and parallel tuned circuits. Works better than a dip meter and costs a lot less. Send for our free brochure.

The price is \$59.95 in the U.S. and Canada. Add \$3.00 shipping/handling. California residents add sales tax.



Fully guaranteed by the originator of the R-X Noise Bridge. ORDER YOURS NOW!

Palomar Engineers

Box 455, Escondido, CA. 92025
Phone: [714] 747-3343

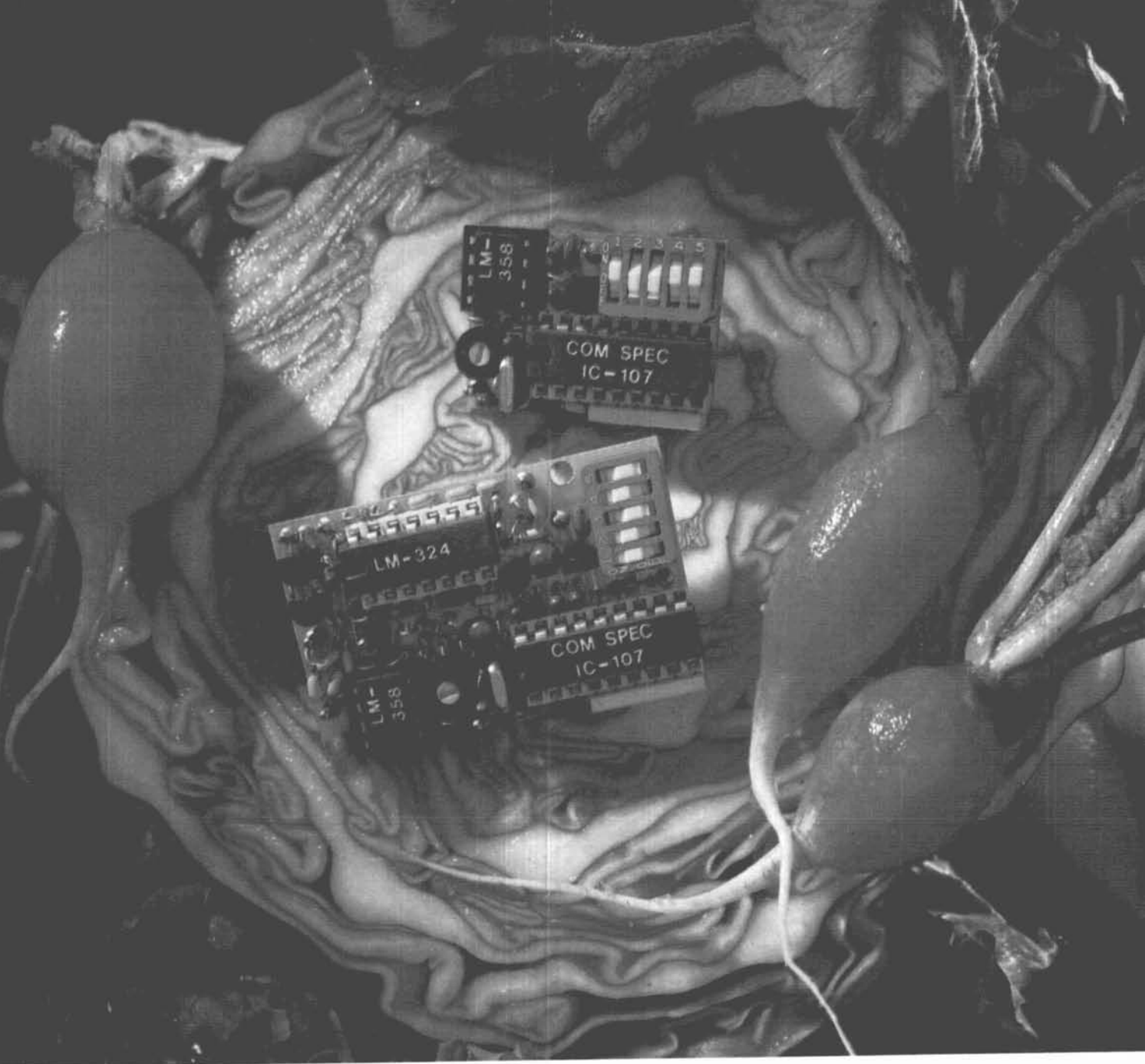

A fresh idea!

Our new crop of tone equipment is the freshest thing growing in the encoder/decoder field today. All tones are instantly programmable by setting a dip switch; no counter is required. Frequency accuracy is astonishing $\pm .1$ Hz over all temperature extremes. Multiple tone frequency operation is a snap since the dip switch may be removed. Our TS-32 encoder/decoder may be programmed for any of the 32 CTCSS tones. The SS-32 encode only model may be programmed for all 32 CTCSS tones plus 19 burst tones, 8 touch-tones, and 5 test tones. And, of course, there's no need to mention our one day delivery and one year warranty.

 **COMMUNICATIONS SPECIALISTS**

426 West Taft Avenue, Orange, California 92667
(800) 854-0547 / California: (714) 998-3021

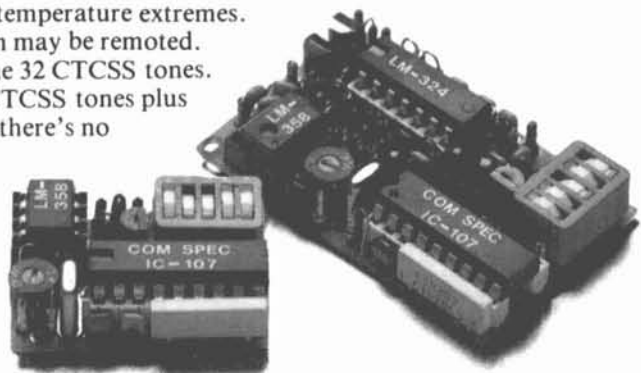

SS-32 \$29.95, TS-32 \$59.95

THE EVOLUTION OF A CHAMPION!

FT-101ZD Mk III



The FT-101ZD Mk III is the latest chapter in the success story of the FT-101 line. Armed with new audio filtering for even better selectivity, the FT-101ZD now includes provision for an optional FM or AM unit. Compare features and you'll see why active operators everywhere are upgrading to Yaesu!

Variable IF Bandwidth

Using two 8-pole filters in the IF, Yaesu's pioneering variable bandwidth system provides continuous control over the width of the IF passband — from 2.4 kHz down to 300 Hz — without the shortcomings of single-filter IF shift schemes. No need to buy separate filters for 1.8 kHz, 1.5 kHz, etc.

Improved Receiver Selectivity

New on the FT-101ZD Mk III is a high-performance audio peak/notch filter. Use the peak filter for single-signal CW reception, or choose the notch filter for nulling out annoying carriers or interfering CW signals. In the CW mode, you can choose between the 2.4 kHz SSB filter and an optional CW filter (600 or 350 Hz) from the mode switch.

Diode Ring Front End

The FT-101ZD now sports a high-level diode ring mixer in the front end. This type of mixer, well known for its strong signal performance, is your assurance of maximum protection from intermod problems on today's crowded bands.

WARC Bands Factory Installed

The FT-101ZD Mk III comes equipped with factory installation of the new 10, 18, and 24 MHz bands recently assigned to the Amateur Service at WARC. In the meantime, use the 10 MHz band for monitoring of WWV!

RF Speech Processor

Not an additional-cost option, the FT-101ZD RF speech processor provides a significant increase in average SSB power output, for added punch in those heavy DX pile-ups. The optimum processor level is easily set via a front panel control.

Worldwide Power Capability

Every FT-101ZD comes equipped with a multi-tap power transformer, which can be easily modified from the stock 117 VAC to 100/110/200/220/234 VAC in minutes. A DC-DC converter is available as an option for mobile or battery operation.

Convenience Features

Designed fundamentally as a high-performance SSB and CW transceiver, the FT-101ZD includes built-in VOX, CW sidetone, semi-break-in T/R control on CW, slow-fast-off AGC selection, level controls for the noise blanker and speech processor, and offset tuning for both transmit and receive. The Mk III optional FM unit may be used for 10 meter FM operation, or choose the optional AM unit for WWV reception or VHF AM work through a transverter (AM and FM units may not both be installed in a single transceiver).

Full Line of Accessories

See your Yaesu dealer for a demonstration of the top performance accessories for the FT-101ZD, such as the FV-101Z External VFO, SP-901P Speaker/Patch, YR-901 CW/RTTY Reader, FC-902 Antenna Tuner, and the FTV-901R VHF/UHF Transverter. Watch for the upcoming FV-101DM Digital Memory VFO, with keyboard frequency entry and scanning in 10 Hz steps!

Nationwide Service Network

During the warranty period, the Authorized Yaesu Dealer from whom you purchased your equipment provides prompt attention to your warranty needs. For long-term servicing after the warranty period, Yaesu is proud to maintain two fully-equipped service centers, one in Cincinnati for our Eastern customers and one in the Los Angeles area for those on the West Coast.

Note: A limited quantity of the earlier FT-101ZD (with AM as standard feature) is still available. See your Yaesu dealer. FT-101ZD Mk III designates transceivers bearing serial #240001 and up, with APF/Notch filter built in and AM/FM units optional.

681

Price And Specifications Subject To
Change Without Notice Or Obligation

YAESU
The radio.



YAESU ELECTRONICS CORP., 6851 Walthall Way, Paramount, CA 90723 • (213) 633-4007
YAESU Eastern Service Ctr., 9812 Princeton-Glendale Rd., Cincinnati, OH 45246 • (513) 874-3100

NEW

"DX-traordinary."



Superior dynamic range, auto. antenna tuner, QSK, dual NB, 2 VFO's, general coverage receiver.

TS-930S

The TS-930S is a superlative, high performance, all-solid state, HF transceiver keyed to the exacting requirements of the DX and contest operator. It covers all Amateur bands from 160 through 10 meters, and incorporates a 150 kHz to 30 MHz general coverage receiver having an excellent dynamic range.

Among its other important features are, SSB slope tuning, CW VBT, IF notch filter, CW full break-in, automatic antenna tuner, and a higher voltage operated solid state final amplifier. It is available with or without the AT-930 automatic antenna tuner built-in.

TS-930S FEATURES:

- * **160-10 Meters, with 150 kHz - 30 MHz general coverage receiver.**
Covers all Amateur frequencies from 160-10 meters, including new WARC, 30, 17, and 12 meter bands, on SSB, CW, FSK, and AM. Features 150 kHz - 30 MHz general coverage receiver. Separate Amateur band access keys allow speedy band selection. UP/DOWN bandswitch changes in 1-MHz steps. A new, innovative, quadruple conversion, digital PLL synthesized circuit provides superior frequency accuracy and stability, plus greatly enhanced selectivity.
- * **Excellent receiver dynamic range.**
Receiver two-tone dynamic range, 100 dB typical (20 meters, 500 Hz CW bandwidth, at sensitivity of 0.25 μ v, S/N 10 dB), provides the ultimate in rejection of IM distortion.
- * **All solid state, 28 volt operated final amplifier.**
The final amplifier operates on 28 VDC for lowest IM distortion. Power input rated at 250 W on SSB, CW, and FSK, and at 80 W on AM. Final amplifier protection circuit with cooling fan, SWR/Power meter built-in.
- * **Automatic antenna tuner, built-in.**
Available with AT-930 antenna tuner built-in, or as an option. Covers Amateur bands 80-10 meters, including the new WARC bands. Tuning range automatically

pre-selected with band selection to minimize tuning time. "AUTO-THRU" switch on front panel.

- * **CW full break-in.**
CW full break-in circuit uses CMOS logic IC plus reed relay for maximum flexibility, coupled with smooth, quiet operation. Switchable to semi-break-in.
- * **Dual digital VFO's.**
10-Hz step dual digital VFO's include band information. Each VFO tunes continuously from band to band. A large, heavy, flywheel type knob is used for improved tuning ease. T.F. Set switch allows fast transmit frequency setting for split-frequency operations. A=B switch for equalizing one VFO frequency to the other. VFO "Lock" switch provided. RIT control for ± 9.9 kHz receive frequency shift.
- * **Eight memory channels.**
Stores both frequency and band information. VFO-MEMO switch allows use of each memory as an independent VFO. (the original memory frequency can be recalled at will), or as a fixed frequency. Internal Battery memory back-up, estimated 1 year life. (Batteries not Kenwood supplied).
- * **Dual mode noise blanker ("pulse" or "woodpecker").**
NB-1, with threshold control, for pulse-type noise. NB-2 for longer duration "woodpecker" type noise.
- * **SSB IF slope tuning.**
Allows independent adjustment of the low and/or high frequency slopes of the IF passband, for best interference rejection.
- * **CW VBT and pitch controls.**
CW VBT (Variable Bandwidth Tuning) control tunes out interfering signals. CW pitch controls shifts IF passband and simultaneously changes the pitch of the beat frequency. A "Narrow/Wide" filter selector switch is provided.
- * **IF notch filter.**
100-kHz IF notch circuit gives deep, sharp, notch, better than -40 dB.
- * **Audio filter built-in.**
Tuneable, peak-type audio filter for CW.
- * **AC power supply built-in.**
120, 220, or 240 VAC, switch selected (operates on AC only).

- * **Fluorescent tube digital display.**
Fluorescent tube digital display has analog type sub-scale with 20-kHz steps. Separate 2 digit display indicates RIT frequency shift.
- * **RF speech processor.**
RF clipper type processor provides higher average "talk-power", plus improved intelligibility. Separate "IN" and "OUT" front panel level controls.
- * **One year warranty.**
The TS-930S carries a one year limited warranty on parts and labor.
- Other features:**
 - * SSB monitor circuit, 3 step RF attenuator, VOX, and 100-kHz marker.
- Optional accessories:**
 - * AT-930 automatic antenna tuner.
 - * SP-930 external speaker with selectable audio filters.
 - * YG-455C-1 (500 Hz) or YG-455CN-1 (250 Hz) plug-in CW filters for 455-kHz IF.
 - * YK-88C-1 (500 Hz) CW plug-in filter for 8.83-MHz IF.
 - * YK-88A-1 (6 kHz) AM plug-in filter for 8.83-MHz IF.
 - * MC-60 (S-8) deluxe desk microphone with UP/DOWN switch.
 - * TL-922A linear amplifier.
 - * SM-220 station monitor.
 - * HC-10 digital world clock.
 - * HS-6, HS-5, HS-4 headphones.

More information on the TS-930S is available from all authorized dealers of Trio-Kenwood Communications 1111 West Walnut Street, Compton, California 90220

KENWOOD
...pacesetter in amateur radio



Specifications and prices are subject to change without notice or obligation.